

# Methodology for improving flow to achieve lean manufacturing in shipbuilding

---

**Kolić, Damir**

**Doctoral thesis / Disertacija**

**2011**

*Degree Grantor / Ustanova koja je dodijelila akademski / stručni stupanj:* **University of Rijeka, Faculty of Engineering / Sveučilište u Rijeci, Tehnički fakultet**

*Permanent link / Trajna poveznica:* <https://um.nsk.hr/um:nbn:hr:188:570472>

*Rights / Prava:* [Attribution-NonCommercial-NoDerivatives 4.0 International/Imenovanje-Nekomercijalno-Bez prerada 4.0 međunarodna](#)

*Download date / Datum preuzimanja:* **2024-08-08**



*Repository / Repozitorij:*

[Repository of the University of Rijeka Library - SVKRI Repository](#)



UNIVERSITY OF RIJEKA  
FACULTY OF ENGINEERING

**METHODOLOGY FOR IMPROVING FLOW TO ACHIEVE  
LEAN MANUFACTURING IN SHIPBUILDING**

PhD Dissertation

Damir Kolić

Rijeka (2011)



UNIVERSITY OF RIJEKA  
FACULTY OF ENGINEERING

**METHODOLOGY FOR IMPROVING FLOW TO ACHIEVE  
LEAN MANUFACTURING IN SHIPBUILDING**

PhD Dissertation

Damir Kolić

Mentor: Prof. D.Sc. Nikša Fafandjel

Rijeka (2011)





Sveučilište u Rijeci  
**TEHNIČKI FAKULTET**  
-Fakultetsko vijeće-  
Klasa: 602-04/09-02/36  
Ur. br.: 2170-57-43-09-52  
Rijeka, 28. rujna 2009.

Fakultetsko vijeće Tehničkog fakulteta Sveučilišta u Rijeci, na svojoj 36. (16.) sjednici u akad. god. 2007./08./09./10, održanoj 25. rujna 2009. donijelo je sljedeću

## ODLUKU

Sukladno izvješću Stručnog povjerenstva, u sastavu: prof. dr. sc. Nikša Fafandjel, prof. dr. sc. Bruno Čalić, izv. prof. dr. sc. Albert Zamarin te pozitivne ocjene prijave i obrane teme doktorskog rada, utvrđuje se da pristupnik *Damir Kolić, mag. ing. nav. arch.* ispunjava Zakonom propisane uvjete za prijavu i izradu teme doktorskog rada naslovljenog:

*„Metodologija za unapređenje brodograđevnih procesa temeljena na konceptu vitke proizvodnje“*

Mentorom se imenuje prof. dr. sc. Nikšu Fafandjela.



Dekan

*Tonči Mikac*  
Prof. dr. sc. Tonči Mikac

Dostaviti:

1. Damir Kolić, mag. ing. nav. arch.
2. Mentor, prof. dr. sc. Nikša Fafandjel
3. Služba studentske evidencije
4. Pismohrana FV



## ABSTRACT

The shipbuilding industry is very competitive, and shipyard management must strive to improve productivity as a way of keeping up with the competition. Analysis of the assembling of interim products through shipyard process lanes is important from a standpoint of modern shipbuilding techniques and methods which includes the *lean manufacturing* and *design for production* concepts. Whereas the *design for production* concept has been readily applied in many shipyards, a *lean manufacturing* methodology for shipyards is lacking. Therefore, the aim of this dissertation is to provide a methodology for improving flow of interim products by applying the *lean manufacturing* concept. Since shipyard management is usually not sure how to approach a transformation of its facilities due to the risks involved, this dissertation couples lean transformation with risk analysis to compare the key parameter for comparing productivity, man-hours. Based upon this it is clear that while making *design for production (DFP)* changes will improve productivity up to 30% when technology changes are made in complement with methodology changes, application of the *lean manufacturing* methodology brings productivity improvements of 60%.

**Key words:** shipbuilding process, lean manufacturing, lean transformation, design for production, risk analysis, interim products

## SAŽETAK

Brodograđevna industrija je vrlo konkurentna i uprave brodogradilišta moraju nastojati poboljšati proizvodnju radi održavanja položaja na tržištu. Analiziranje načina sastavljanja međuproizvoda kroz brodograđevni proces je važno sa stajališta modernih brodograđevnih tehnika i metoda koje uključuju koncepte *vitke proizvodnje* i *projektiranja za proizvodnju*. Dok se koncept *projektiranja za proizvodnju* koristio u mnogim brodogradilišta, metodologija za *vitku proizvodnju* nedostaje. Cilj ove disertacije je omogućiti metodologiju za poboljšanje protoka međuproizvoda kroz primjenu koncepta *vitke proizvodnje*. Uprave brodogradilišta često puta nisu sigurne kako najbolje pristupiti transformaciji svojih postrojenja radi postojećih rizika. Ova disertacija povezuje vitku transformaciju sa analizom rizika radi usporedbe ključnog parametra u uspoređivanju produktivnosti, efektivnih radni sati. Postaje jasno kako kreiranje promjene korištenjem koncepta *projektiranja za proizvodnju* poboljšava proizvodnju do 30% kada promjene na tehnologiji se naprave komplementarno sa metodologijom, dok aplikacija koncepta *vitke proizvodnje* donosi poboljšanje proizvodnje od 60%.

**Ključne riječi:** brodograđevni proces, vitka proizvodnja, vitka transformacija, projektiranje za proizvodnju, analiza rizika



## **FOREWORD**

One of the major problems facing many shipyards is the lack of productiveness. Whereas many shipyards succeed in building and delivering vessels which are satisfactory with regards to the design and meeting owners and classification society requirements, many fail in the area of efficiency during manufacturing. The discrepancies between white collar management and blue collar production are large, and in order to change the declining shipbuilding trends it is imperative to apply scientific methods in production. A lean manufacturing methodology geared and developed for shipyards is such an approach that should be applied, given the fact that other industries that have made lean manufacturing transformations to their enterprises have shown significant improvements.

I would foremost like to thank my mentor Professor Nikša Fafandjel for giving me the opportunity to work in an environment where the application of scientific engineering is considered important, and for supporting me with all my decisions. Likewise, Professor Richard Lee Storch, an expert in lean manufacturing from the University of Washington significantly paved the way in my lean manufacturing research.

A special thanks to my wife Diana and son Jakov, as well as my parents and sister for their considerable support.



# TABLE OF CONTENTS

<b>1. INTRODUCTION .....</b>	<b>1</b>
1.1. PROBLEM .....	2
1.2. REVIEW OF RESEARCH .....	4
1.3. HYPOTHESIS FOR IMPROVING FLOW .....	5
<b>2. PRINCIPLES IN LEAN MANUFACTURING.....</b>	<b>9</b>
2.1. FIVE MAIN LEAN PRINCIPLES .....	9
2.1.1. <i>Specifying value</i> .....	9
2.1.2. <i>Identifying the value stream</i> .....	9
2.1.3. <i>Flow</i> .....	10
2.1.4. <i>Pull</i> .....	10
2.1.5. <i>Perfection (acceptable quality)</i> .....	11
2.2. OTHER LEAN PRINCIPLES .....	11
2.2.1. <i>Just in time and Built-in quality</i> .....	11
2.2.2. <i>5S</i> .....	12
2.2.3. <i>The 7 Wastes</i> .....	12
2.2.4. <i>Kaizen (Continuous Improvement)</i> .....	13
<b>3. DFP ANALYSIS OF PANEL AND BLOCK ASSEMBLY METHODS AND ITS LEAN TRANSFORMATION .....</b>	<b>15</b>
3.1. GROUP TECHNOLOGY AND ITS DERIVATIVES IN SHIPBUILDING .....	15
3.2. PANEL AND BLOCK ASSEMBLY METHODS .....	16
3.3. GENERATION AND EVALUATION OF ASSEMBLY OPTIONS FOR PRINCIPAL BLOCK ASSEMBLY METHODS .....	19
3.3.1. <i>Summary of block assembly methods evaluation</i> .....	116
3.3.2. <i>Work content analysis</i> .....	116
3.4. PURPOSE OF DEVELOPING THE TYPE PLAN .....	119
3.5. TRADITIONAL WORKSTATION ACTIVITIES IN PANEL AND BLOCK ASSEMBLY .....	119
3.6. LEAN TRANSFORMATION OF SHIPBUILDING BLOCK ASSEMBLY .....	123
<b>4. DFP CASE STUDY .....</b>	<b>127</b>
4.1. RATIONALYZING SHIPYARD DESIGNS .....	127
4.1.1. <i>Design configuration analysis</i> .....	130
4.1.2. <i>Structural configuration variation analysis</i> .....	136
4.2. ADJUSTING SHIPYARD PROCESSES ACCORDING TO DFP MANUFACTURING PRINCIPLES .....	140
4.3. TARGETED SHIPYARD PRODUCTION PROCESSES .....	144
4.3.1. <i>Technological constraints of subassembly and assembly</i> .....	145
4.3.2. <i>Block assembly during the assembly phase</i> .....	145
4.3.2.1. <i>Micropanel-line</i> .....	145
4.3.2.2. <i>Robotic line</i> .....	146
4.3.2.3. <i>Panel line</i> .....	146
4.3.2.4. <i>Built-up panel line (KP line)</i> .....	149
4.3.2.5. <i>Final block assembly prior to erection</i> .....	149
4.3.3. <i>Gantt charts of workstation activities</i> .....	154



4.4.	ANALYSIS OF THE TARGETED PRODUCTION PROCESS.....	165
<b>5.</b>	<b>LEAN TRANSFORMATION.....</b>	<b>169</b>
5.1.	ASSEMBLY PRIOR TO LEAN TRANSFORMATION .....	169
5.2.	LEAN TRANSFORMATION PROCESS .....	170
<b>6.</b>	<b>RISK ANALYSIS OF BLOCK ASSEMBLY METHODS .....</b>	<b>193</b>
6.1.	MONTE CARLO APPLICATION IN RISK ANALYSIS.....	193
6.2.	MONTE CARLO RISK ANALYSIS OF ASSEMBLY METHODS .....	195
6.3.	DISCUSSION OF RESULTS .....	199
<b>7.</b>	<b>FUTURE DESIGN GUIDELINES FOR FLAT DOUBLE SKIN BLOCK ASSEMBLY.....</b>	<b>201</b>
<b>8.</b>	<b>CONCLUSIONS .....</b>	<b>209</b>
<b>9.</b>	<b>REFERENCES.....</b>	<b>211</b>
<b>10.</b>	<b>LIST OF SYMBOLS AND ABBREVIATIONS .....</b>	<b>215</b>
<b>11.</b>	<b>LIST OF FIGURES .....</b>	<b>217</b>
<b>12.</b>	<b>LIST OF TABLES .....</b>	<b>221</b>
<b>13.</b>	<b>APPENDIX.....</b>	<b>223</b>

## 1. INTRODUCTION

The global competition between shipyards has become fierce, and simply concentrating efforts on satisfactory ship design without considering the constraints of production early in the design process is risky [1]. Eventually shipyards that refuse to adapt *lean manufacturing* principles and *design for production* methods early in the design and pre-contracting process will financially suffer and eventually close down. This is the situation with many shipyards in the world today. Therefore the aim of this work is to describe how combining *lean manufacturing* principles with *design for production* principles can be implemented in a shipyard.

The traditional approach of naval architects in ship design includes creating a design which satisfies the requests and expectations of the Owner as well as being in compliance to classification society rules. Design for production goes a major step further and aims to reduce ship production costs to a minimum, while simultaneously complying with both owner and classification society rules. The vessel must “fulfill its operational functions with acceptable safety, reliability and efficiency”[2]. Simply relying on the experience of engineers in the project-sales and design departments is not enough. It is necessary to create a *lean manufacturing* methodology that can be used by shipyard management to make decisions concerning improving the productivity of the shipyard. Once the contract is signed, then it is often too late to make changes that will benefit and keep production costs to a minimum.

Many shipyards lack clearly defined production methods and design/engineering standards. “This means that engineering detail design and methods of steel assembly are left to the individual preferences of the engineering and production personnel. Production engineering activities are focused on the introduction of new methods and technology, often without full consideration of the implications to the design and on the facilities”. There are often multiple possible variations for the assembly of just one specific double bottom block type. “Also there is no quantitative method for defining what is best for the current shipyard technology level and which method would be best for the future” [2]. Considering present methods of assembly and gradually applying newer methods requires constant attention to quality management, because improving methods without considering the needs of quality and upgrading technology in parallel is risky. Likewise improving technology without making changes to the methods used by the workers and the engineering staff is unefficient and wasteful as well. Therefore a Monte Carlo Analysis will graphically show what risks are involved and how shipyard management could make decisions which will be in compliance with *lean manufacturing* principles.

The *lean manufacturing* methodology will include the following:

- analyzing design variations and structural configurations of a shipbuilding production program;
- analyzing the constraints of the panel-block assembly lines;
- analyzing and evaluating the principle methods and sub-options of assembling panels and blocks;
- work content of a typical flat double bottom block (weld-length and man-hours);
- developing a type plan for assembling a typical double-bottom block;
- Lean transformation of the main shipbuilding processes
- Lean transformation of a typical interim shipbuilding product

- Monte Carlo analysis useful for estimating man-hours and minimizing risk in decision making for shipyard management.

## 1.1. PROBLEM

The problem with many shipyards that are loosing or have lost competitiveness in the world shipbuilding market are that its assembly processes and shipbuilding methods are becoming outdated and un-productive in comparison to the most advanced shipyards that have adopted or are in the process of applying *lean manufacturing* principles. [3], [4]. The competitive edge can be improved by decreasing production costs which make up to 40% of total ship costs. Industries that have made transformations from traditional batch and queue systems towards *lean manufacturing* facilities have had increases in productivity of up to 90% [5]. The Japanese Ishiwajima-Harima Heavy Industries (IHI) shipyards in Japan have come the closest to implementing *lean manufacturing* principles in its shipyards. Japanese shipbuilding owes its survivability to the highest productivity level [6]. At these levels it is clear that survivability in the shipbuilding market will require major changes in shipyard production facilities.

Improving productivity is a continuing challenge that most businesses face. Management has the responsibility to set goals and make action plans that improve productivity. During the 1940s and 1950s, productivity measurement was based primarily on output, “or the production of as much as possible for a given input”. Efficiency or “production at lowest cost” took priority over quantity during the 1960s and 1970s. “Today, productivity is effectiveness, which is a combination of right product, right time, quality, and efficiency”. Shipyard management is exclusively responsible for the use of man power, assembly process efficiency and the effectiveness of planning which results in productivity. Productive shipyards have the following characteristics [6], [7]:

- PWBS (product work breakdown structure),
- well defined aims and policy,
- use of takt time and short build cycles,
- application of integrated hull outfitting and painting (IHOP) methods,
- constant attention by shipyard management of “productivity measures”,
- technical documentation well adjusted for production.

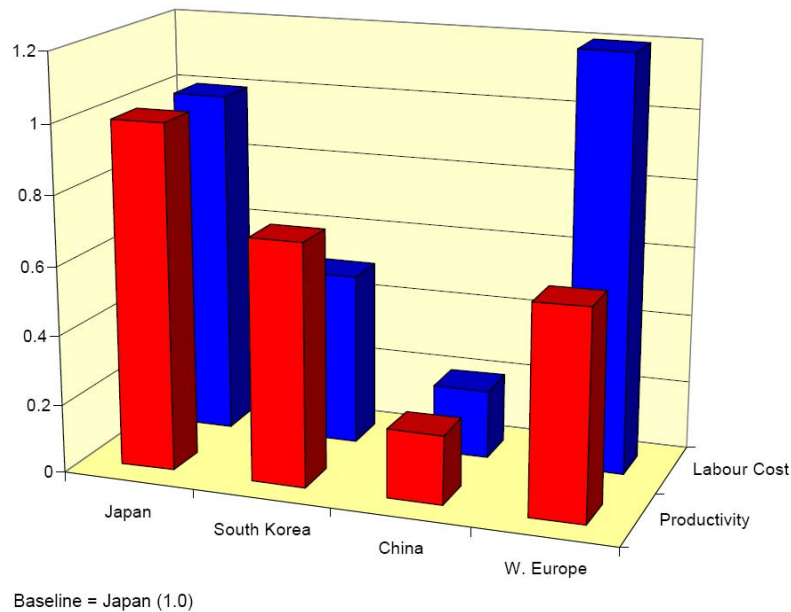
Improving productivity is done by transforming present day assembly processes into more efficient ones where the result is a decrease in man-hours to build interim products which make up the building blocks of the entire vessel. One key area in all shipyards where *lean transformations* will bring about much productivity improvement is the block assembling processes which includes the panel and the built up panel lines since roughly between 40-75 % of commercial vessel steel weight is derived from automated processes, according to the Norwegian Ship Research Institute [8]. For instance the panel-block assembly line productivity of many shipyards is below the levels of world-class shipyards such as Ishikawajima-Harima Heavy Industries Co., Ltd., otherwise known as IHI [9]. One of the key ways in reducing costs for building vessels is through decreasing the man-hours and the duration time of the shipbuilding processes. The panel-block assembly process due to its repetitive nature allows for lean manufacturing principles to enhance this decrease in man-hours during the assembly of the interim products [10].

The Asian shipbuilding countries of Korea, Japan and China build more than 75% of all world ships whereas European shipyards deliver 16.5% of all world vessels. Asian shipyards

concentrate on cargo ship production programs, while simultaneously increasing its percentage of high value added complex ships from year to year. As a result there is a larger economy of scale due to series production and large shipyards. Even so there are large differences between Japan, Korea and China. The focus of many West European yards is “on high value complex types of commercial ships with a high degree of outfitting.” This results in a low economy of scale due to one-off products and many small shipyards. The material thicknesses are also relatively low [11].

United States shipyards “focus almost exclusively on naval ships” [11]. Since the U.S. Navy is the largest navy in the world, its shipbuilding engineering base maintains survivability. However most experts in the naval engineering field recognize that the U.S. Naval program will have increased benefits from deepening the U.S. commercial shipbuilding capabilities. Many National Research Shipbuilding Research Program (NSRP) studies recognize the fact that advanced techniques that are employed in foreign yards especially Japan, need to be practised in the United States as well because the future of shipbuilding in the world relies heavily on being competitive in the commercial shipbuilding fleet.

Chinese shipyards are also on the verge of moving towards applying *lean manufacturing* principles. This means that it is imperative for most shipyards that wish to be competitive in the world market to start moving towards *lean manufacturing* as well. Otherwise, the situation will lead to the closing of many shipyards that have traditionally been powerhouses. The integration of the “Lean Shipbuilding System” and low labor cost in China will make China even more competitive in the world market [12].



**Fig. 1.1. Comparison of Japanese shipbuilding productivity and labor costs [13]**

The above figure shows that Japan has the most productive shipyards in the world, whereas Western Europe is below South Korea but more productive than China. The problem is that shipyards that fail to adopt new *lean* technologies and methodologies will eventually have to compete not only against Japan but also China which has the lowest labor costs. Once *lean manufacturing* principles begin to be applied, coupled with the still expected lower labor

costs, it will virtually be impossible to be economically justifiable. Therefore, the sooner shipyard management of European and U.S. shipyards realize this the better.

An additional problem that shipyard management faces is how to decide where to apply changes in the production capabilities of their shipyards. The lack of a risk analysis assessment is preventing shipyard management from taking major leaps into applying new concepts such as *lean manufacturing*. Shipyard management which does not carefully weigh the considerations of both changing methodology and the complementary technology according to *lean manufacturing* principles will eventually lose competitiveness [14].

## 1.2. REVIEW OF RESEARCH

Various concepts and methodologies exist in the scientific field of improving shipyard productivity and therefore competitiveness. The *design for production* concept has been applied in many world class shipyards with various degrees of success [2]. Product mixes represent the reality of many shipyards in order to maintain survivability. Likewise, the *design for production* methodologies have shown that its incorporation early in the ship design process yields benefits at various types of shipyards, including medium sized shipyards [15]. Additionally the *design for production* concept as employed by the most advanced world shipyards requires a shipyard with a Product Work Breakdown Structure (PWBS) in order to fully take advantage of repeatable interim products. The use of robotic welding to perform 90% of all primary panel welding work simultaneously is a given in the most advanced shipyards [16].

Additionally, applying the *design for production* concept with risk analysis is a new methodology that is useful for shipyard management when deciding upon shipbuilding technology and methodology improvements [14]. Determination of technological parameters for the design rationalization of a shipbuilding production program further enhances the productivity of shipyards with product mixes [17].

The shipbuilding field has seen the verge of risk analysis used to aid production activities. These include the use of Monte Carlo methods using the triangular distribution for predicting duration times [18] , [19]. Likewise risk analysis of contracting large engineering projects using Monte Carlo normal distribution [20]. An advancement upon these was made by applying Monte Carlo methods through the use of PERT distributions which is shown to be more acceptable in shipbuilding projects in conjunction with estimating man-hours which more accurately reflects shipbuilding production costs than duration times alone [14].

The advanced welding robot system applied at Ishikawajima-Harima Heavy Industries Co. Ltd, (IHI) and the development of the “unit panel and slit process” has resulted in improved ship quality, use of non-skilled workers in production, decrease in labor costs, and improvement of working site conditions. This advanced automation and the application of the one-side automatic Flux-Copper Backing (FCB) machines to assemble panels has resulted in a breakthrough in production efficiency [10].

Japanese shipyard management is aware that their skilled shipyard working force is aging and or retiring, and in order to maintain its competitive edge, it will be necessary to preserve the skills of experienced journeymen. The *Digital Meister Project* has the aim of protecting and preserving shipyard know-how and creating efficient training procedures for new workers in order to decrease the learning curve [11]. Likewise, the more that processes become recorded

down and also entered into its production system, the less need there is for long training periods. Japan has invested in researching the line heating process “where high skill is required for the accurate forming and straightening of steel plates”. The training period lasts up to ten years. Much research in predicting deformation due to line heating has resulted in the automation of line heating. Additionally, the proportion of automatic and semiautomatic welding has increased to 94.5%, whereas manual electrode welding has decreased to 5.5%. The Japanese shipbuilding industry has handled the problem of more than 50% of the workforce being over the age of 50 by transferring the skills to the successors, using information technology to ease the transition for unskilled workers, and replacing the aging skilled workers with automation [21].

Research in *lean manufacturing* has been performed by NSRP. However the research itself is lacking concrete methodologies or case examples for lean transformation in shipbuilding [22], [23], [24].

### 1.3. HYPOTHESIS FOR IMPROVING FLOW

Productivity and product performance are one of the “most important contributors to shipyard competitiveness”. Such techniques include “methods to improve the economy of scale in shipyard manufacturing by modularization and increased pre-outfitting as well as simulation techniques to enhance management of the shipyard production chain” [11].

*Design for Production* (DFP) and *lean manufacturing* principles all make improvements in shipyards to certain degrees. However, the research in *lean manufacturing methodology* for transforming a shipyard based on traditional and present day technologies is lacking. IHI shipyards have come the closest to transforming its production towards *lean manufacturing*. However the detailed information is lacking. Additionally, case studies are lacking which would demonstrate the improvement by *lean manufacturing* transformation. In addition even some areas of IHI are not as lean as they could be [4].

DFP can be further developed to make improvements [2], [11]. However, it is clear that the savings made from exclusively adapting DFP methods in shipyards is limited. Therefore it is necessary to analyze the major concept of *lean manufacturing*.

The only shipyards known to have applied one piece flow are IHI shipyards [4], [10]. These methods make strides in improving shipyard production. However, a lean transformation methodology for shipyards is lacking in the panel and block assembly process.

Due to the multiple industries which have implemented *lean manufacturing* principles have become successful, the development of a lean transformation methodology will be useful [1]. The aim is to improve the flow of interim products. This can be shown by decreasing the man hours to produce interim products as well as decreasing the duration time. Therefore analyzing the present assembly process by using metrics of duration time and man-hours expended will be useful. The assembly process transformed according to the *lean manufacturing* methodology will be significantly better (savings over 50% in duration time and man-hours). These significant savings directly lead to decreasing shipyard labor costs while meeting all demands for the customer. The integration of *risk analysis* with *lean transformation* enhances the realistic perspective of time and man-hour estimation.

Shipyard management must decide whether it will take the next step and bring about change in the shipyard. It appears that the deeper analysis and integration of both the *lean manufacturing* concept along with *risk analysis* will enable shipyard management of virtually any newbuilding shipyard of medium to large ships (80 m – 300 m in length) that has a panel line or is interested in investing in the technology.

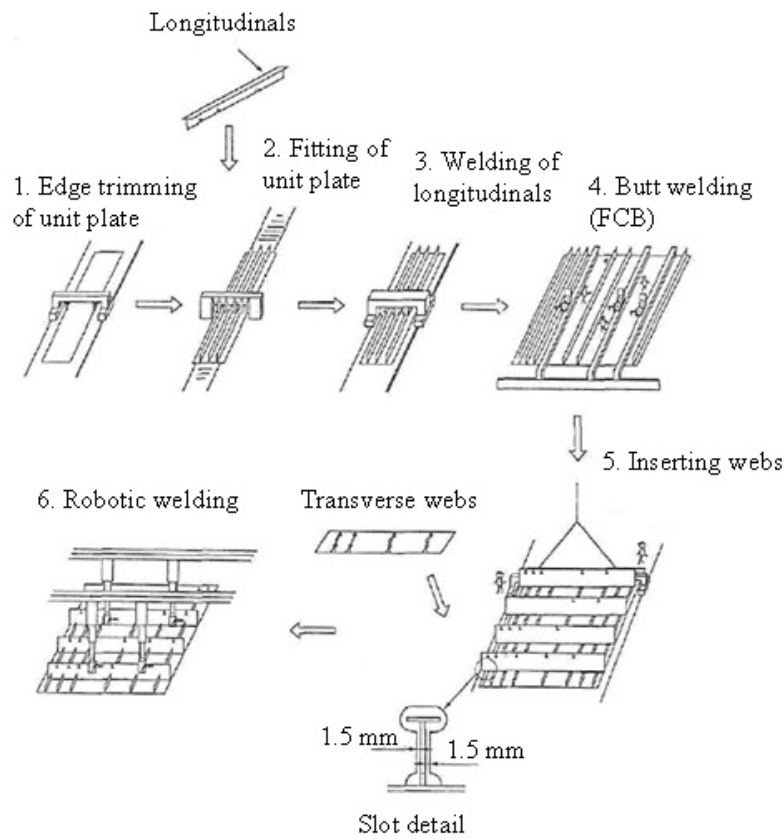
Whereas Japanese industry continues to build ships with both lower and higher compensated gross tonnage (CGT) profitably due to the implementation of *lean manufacturing* techniques, it is necessary for shipyards that have not taken serious strides in lean implementation to make changes. It is risky not to approach *lean manufacturing* principles.

The hypothesis is that man-hours and duration time can significantly decrease with implementation of product value chain analysis, one-piece-flow manufacturing, just in time and level production, takt time, zero inventory management, and built-in quality [24]. Analyzing the main shipyard processes and applying the above lean manufacturing principles will do major improvements in decreasing man-hours and bringing significant savings to the shipyard. This way shipyards that are not competitive in terms of major costs, can become profitable.

The *unit panel and slit method* in flat panel assembly allows for one-piece flow identified by Liker and Lamb. It is used by the most successful Japanese shipyards such as IHI. “Stiffened panels are built up on single plates, *unit panels* instead of joined plate subassemblies” Likewise, “implementation of collarless *slit* construction”. The “lean production goal is cost reduction via elimination of unnecessary operations, waiting times and inventories” [4].

One piece flow as mentioned can be explained on the panel and completed panel lines as a “unit panel and slit” process. The first step involves accepting single steel plates which are between 1,5 to 4,5 m in width. At the first workstation, the single steel plate is accepted and trimmed as necessary. At the second workstation longitudinals are fitted on the unit panel simultaneously using automated processes. The longitudinals are then simultaneously welded, and the unit panel is assembled. This process is repeated for three or four more unit panels. Then the four unit panels are butt welded by one-side automatic welding – Flux-Copper Backing (FCB) machines. The advantages of FCB welding is that it is not necessary to weld the steel plates on both sides [4], [10]. See Figure 1.2.

The next process which is frequently called built-up panel process follows. Transverses or floors that were subassembled with slots instead of cut-outs, virtually unheard of in European yards, are then slid through the longitudinals. The advantage of the slots are that they do not require lugs to be placed as is the situation with cut-outs. These slots “conform closely to the profile of the longitudinals”. The principal benefits of the unit panel and slit method follow the ideas of *lean manufacturing* [4], [10]. See Figure 1.2.



**Fig. 1.2. Unit panel and slot assembly method [10]**

Most shipyards outside of Japan do not utilize one piece flow as recommended by Liker and Lamb [3]. Therefore one of the key approaches in transforming a shipyard towards lean production is the creation of one-piece flow, which allows for the enhancement of takt time and a levelled production. Therefore the aim of this dissertation is to develop and justify a methodology for the transformation of shipyard processes and design towards one-piece flow. One of the prerequisites for employing one-piece-flow is enabling PWBS. In turn, lean manufacturing also demands that the *Just-in-Time* principle to be integrated along with one-piece flow in order to reap the benefits of balanced production which follows an even takt time.

The hypothesis is that transforming both the facilities and the interim product assembling sequence will decrease the man-hours and cycle time of creating interim products. This in turn means decreasing the total ship costs which is a justification for the *lean transformation* of shipyards in Europe and the United States.

Integrating lean transformation with risk analysis is a practical approach for shipyards that would like to consider alternatives before deciding upon improvements. Shipyard strategy will decide. Risk analysis will enhance the decision making process. In summary, the lean approach will show the significant benefits of its implementation.

The scientific contribution of this work includes the development of a *lean manufacturing methodology* along with an enhanced *design for production* methodology. Finally the *risk*



*analysis* technique is integrated to show the significant man-hour savings of employing *lean manufacturing* over *design for production*.

## 2. PRINCIPLES IN LEAN MANUFACTURING

### 2.1. FIVE MAIN LEAN PRINCIPLES

Almost twenty years have passed since the famous book *The Machine That Changed the World* by Womack, Jones and Roos launched the idea of lean to the West [25]. According to Bicheno and Holweg, present-day experts in *lean manufacturing*, the five lean principles include [25]:

- 1) Specifying value from the customer's perspective,
- 2) Identifying the Value Stream,
- 3) Flow,
- 4) Pull,
- 5) Perfection (Acceptable quality).

#### 2.1.1. Specifying value

Specifying value from the customer's point of view includes concentrating on processes that produce interim products which make up essential blocks of the final product, a completed ship. In this work the panel-block assembly process was chosen as one of the key processes where realistic analysis and improvements can be made. See Figure 2.1.

#### 2.1.2. Identifying the value stream

The second principle of identifying the value stream is a prerequisite to improving flow. The value stream includes all processes that are involved in the manufacturing process which create added value. The block manufacturing scope starts with panel production and leads towards completed blocks. It is important to understand the process breakdown by dividing it into activities and analyzing how improvements can be made. The block assembly process is broken down into 9 main activities which will be discussed in more detail later (Figure 2.1):

- 1) Panel assembly,
- 2) Panel welding,
- 3) Panel layout,
- 4) Longitudinal fitting,
- 5) Longitudinal welding,
- 6) Internal structure fitting,
- 7) Welding and outfitting of built-up unit,
- 8) Turning and fitting,
- 9) Welding and outfitting.

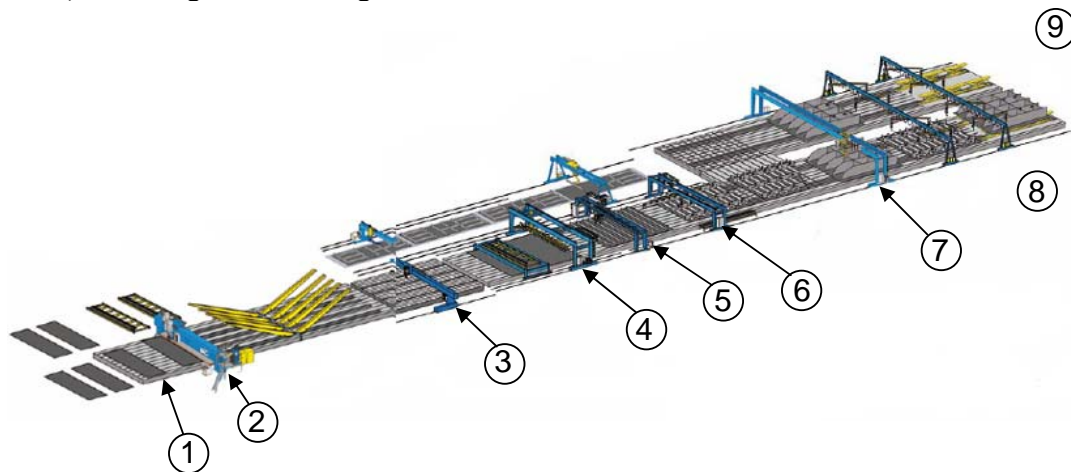


Fig. 2.1. Panel-block assembly line [26], [27], [28]

### 2.1.3. Flow

Flow, the third lean principle is very important because the manufacturing of interim products in shipbuilding is what creates added value and what the customer is willing to pay for. Improving flow requires the avoidance or reduction of batches and queues and the creation of continuous flow. Likewise non-value added activities during the manufacturing processes must be reduced and brought to a minimum. Added-value activities include welding and outfitting, while non-value added activities includes preparations, setting up, waiting, storage, and excessive unnecessary fitting. Please note that while buffers represent non-added value between activities in Figure 2.2 below, there are buffers within the processes themselves as well. For instance the panel line and block assembly processes have internal buffers or non-value added activities which will also need to be reduced. This includes waiting between the internal workstations, and excessive preparations and handling. Combining the panel line with block assembly eliminates the transportation and waiting buffer between the two processes and automatically improves flow [3], [25].

The latest approach by modern world class shipyards is combining the workstations of the panel line and block assembly into one process: panel-block line assembly [28]. In addition to the elimination of transportation between the previously separate processes, the workstations become more logically organized and balance assembly cycle time more efficiently which results in improved flow. This is in compliance to lean quality which aims to always keep cycle times between workstations the same.

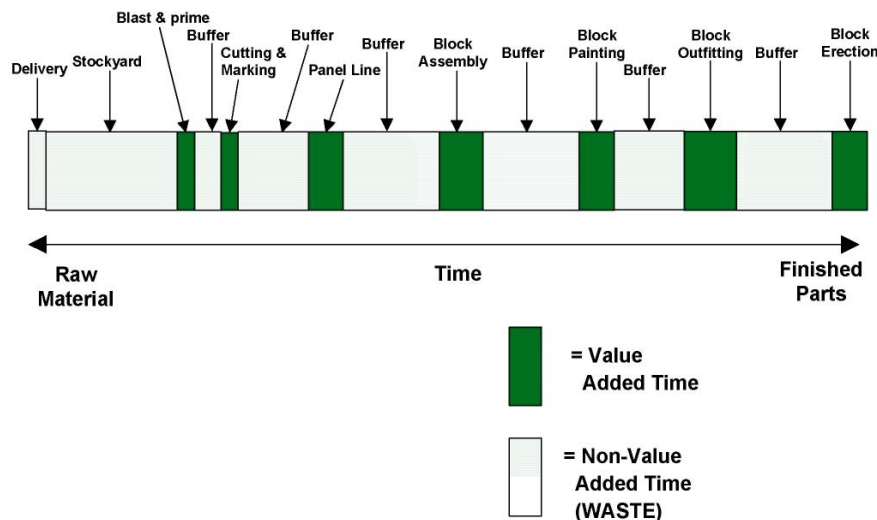


Fig. 2.2. Illustration of value added time and non-value added time [3]

### 2.1.4. Pull

Principle 4 deals with pull which in the panel-block process means that the workstations create intermediate products as required by demand so that large groups of blocks do not collect in the shipyard. This is in compliance to group technology which essentially means that interim products are built in small batches as required by demand as opposed to large batches which results in unnecessary storage and is contrary to lean principles [1].

### 2.1.5. Perfection (acceptable quality)

Finally principle 5 concentrates on perfection or quality which is complementary to flow and creating added value, because if an interim product such as a double bottom block has defects, then flow is interrupted due to required repairs. Likewise the added value of the impaired block is decreased as well. Therefore maintaining and improving upon quality aids continuous flow and the creation of added value interim products.

This work will concentrate on the third and fifth principles which includes improving flow of interim products along with maintaining and or improving quality at the same time, because the two principles are complementary to one another. The shipbuilding industry with many types of manufacturing processes and interim products lacks a specific methodology which will allow Management and production engineers to develop a program which will improve the flow of interim products while maintaining and/or improving quality at the same time. Improving flow without maintaining quality would create bigger problems than it solves, because the interim manufactured products would have to be repaired or reworked, which means that flow would actually be disrupted and not improved and waste would result. In summary the five lean principles are interrelated and it is unrealistic to intentionally ignore any one of them while approaching manufacturing problems from a lean manufacturing point of view.

## 2.2. OTHER LEAN PRINCIPLES

### 2.2.1. Just in time and Built-in quality

Just in Time (JIT) is the lean principle which means that the “right part must arrive at the right time in the right amount” [3]. Buffers are removed as much as possible and takt time is balanced between different workstations. For example in the panel-block line assembly process the movement of the interim products between the different workstations should be relatively balanced so that level flow is achieved. The prerequisite for Just in Time is Built in Quality, because the entire Just in Time system would fail without quality due to the removal of buffers. Therefore due to the reduced interim inventory of Just in Time, the quality must be up to par in order for flow to be continuous. Otherwise there would be many interruptions and interim products would not be built on time. Figure 2.3 below shows the Toyota Production System where the two pillars are Just in Time and Built in Quality, and Operational Stability is the foundation of the house [27].

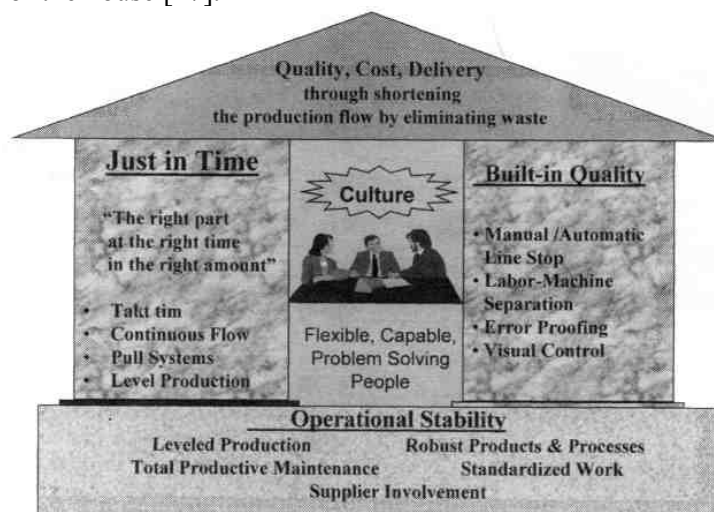


Fig. 2.3. The Toyota Production System [27]

### 2.2.2. 5S

5S is a lean principle which aims to reduce waste, reduce variation and to improve productivity [3]. The five S's stand for the following:

- 1) **Sort** – Sort items by keeping what is needed and getting rid of what is unnecessary.
- 2) **Straighten** (Set in order) – Every tool and all equipment must be placed logically. “A place for everything and everything in its place“ [5]. For instance the workstations of the panel-block assembly line need to have all equipment well organized. Otherwise the man hours will increase.
- 3) **Shine** (Cleanliness) – This involves inspecting for any abnormalities or anomalies and its causes.
- 4) **Standardize** – includes measuring, recording, training and work balancing [3]. This is what is done during the panel and block assembly process analysis.
- 5) **Sustain** (Self Discipline) – The 5S activities need to become a habit. Audits need to be carried out periodically. Ongoing process of continual improvement.



Fig. 2.4. The 5 S's [3]

### 2.2.3. The 7 Wastes

It is important to list the seven wastes which were made by Taichii Ohno, the father of the Toyota Production System [25].

#### 1) Overproduction

Overproduction is making too much too early and is not in compliance with the JIT principle [27]. Therefore it needs to be avoided. For instance if too many panels are created and the block assembly process can not keep up, then panels will start to take up valuable space, and there is more chance that defects will be uncovered late as well. This is risky for any shipyard. Therefore uniform flow should be maintained because it is the key to a well balanced manufacturing process.

#### 2) Waiting

Waiting is in contradiction to smooth flow. Whenever we have workers waiting around for a machine or for other workers, this means that steps should be taken to reduce this.

**3) Unnecessary Motions**

Unnecessary motions are related to workers and facilities layout. For instance shipyards must always strive to reduce overhead welding and maximize downhand welding. Overhead welding is more difficult for workers, requires more time and is less efficient than downhand welding.

**4) Transport**

Transport is a waste that can never be fully eliminated, but it can be reduced. Shipyard panel-block assembly lines are created in order to reduce the transportation that would otherwise be necessary without them. At the same time these same line facilities can and should be improved in order to reduce transport and internal movement even further.

**5) Overprocessing(Inappropriate Processing)**

Overprocessing involves using the inappropriate tools and methods for performing a task. For instance during the assembly of a block, overprocessing leads to greater man hours than necessary and should be avoided.

**6) Unnecessary Inventory**

Inventory is considered the “enemy of quality and productivity” because it takes up valuable space and hinders communication as well as slowing down the identification of problems with quality [3].

**7) Defects**

Defects cause waste because they require time and space for performing repair and rework.

**2.2.4. Kaizen (Continuous Improvement)**

Kaizen is the Japanese word for continuous improvement, since “no process can ever be declared perfect, there is always room for improvement“ [25]. In the case of the shipbuilding panel-block assembly line, even after production engineers determine which method is best for the present technology level of the shipyard, it is necessary to continue to analyze new methods and technologies that will improve the process even further. This is the only way that shipyards could expect to be competitive in the global market.

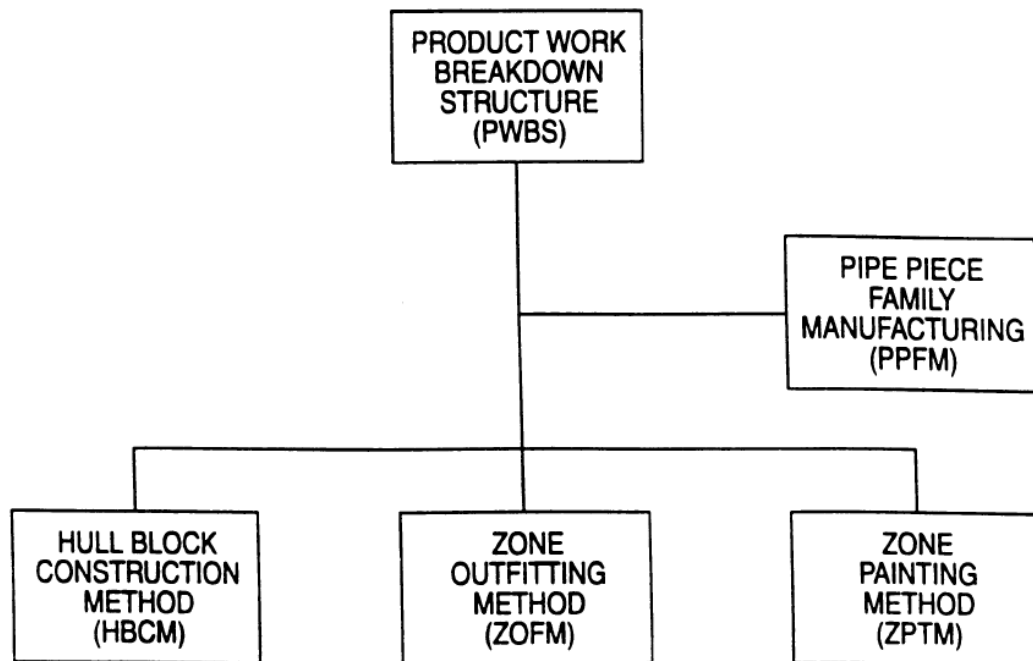


### 3. DFP ANALYSIS OF PANEL AND BLOCK ASSEMBLY METHODS AND ITS LEAN TRANSFORMATION

#### 3.1. GROUP TECHNOLOGY AND ITS DERIVATIVES IN SHIPBUILDING

Group technology is a generic term for manufacturing by grouping parts with similar characteristics and “forming production cells with a group of dissimilar machines and processes” [2]. It is also commonly known as family manufacturing.

“Group technology is an approach to production which identifies similarities in the manufacture of products and organizes production facilities as a series of groups, or cells, containing the necessary resources to make the products. It aims to gain economy in batch and one of a kind production” [2].



**Fig. 3.1. Diagram of a product work breakdown structure (PWBS) [28]**

The integrated approach that derives from the group technology approach includes the integrated hull block construction, outfitting and painting method (IHOP). IHOP is again broken down into hull block construction method (HBCM), zone outfitting method (ZOFM), zone painting method (ZPTM) and family manufacturing such as in pipe piece family manufacturing (PPFM). Likewise IHOP assumes that a product oriented work breakdown structure (PWBS) is used which details and plans the manufacture of all interim products in a logical and coordinated manner (See Figure 3.1) [28]. Likewise the use of *design for production* (DFP) further reiterates the practicality of IHOP and PWBS.

The hypothesis of this dissertation is that combining *lean manufacturing* principles with proven DFP, IHOP and PWBS should result in a methodology that will further reduce cycle time and man hours of interim product assembly, regardless of the production program (ship



types). The production facilities and design need to be enhanced by the combination of these advanced manufacturing principles.

### 3.2. PANEL AND BLOCK ASSEMBLY METHODS

The method that a Shipyard uses to assemble panels and blocks is important to consider because choosing the most appropriate method for the shipyard will improve productivity and the flow of interim products. At the same time the complementary quality status is also necessary to consider, because whereas one method may reduce the total quantity of weld length of a typical double-bottom block, it may not necessarily mean that efficiency will be improved.

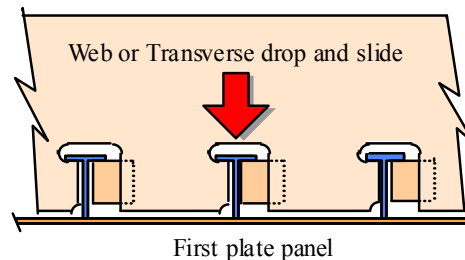
There are two basic block assembly concepts used in shipbuilding [2]:

- traditional built-up panel assembly ,
- egg-box structure assembly,

Furthermore, there exist eight principle block assembly methods that can be applied with seven assembly sequence variations in each. The eight principle assembly methods are as follows in Figures 3.2-3.9.

#### **Principal Block Assembly Method 1 :**

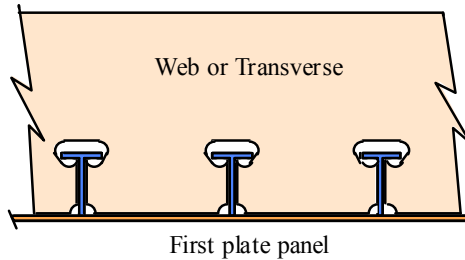
The longitudinals are fitted and welded to the first plate panel. The webs have longitudinal cut-outs which are fitted over the longitudinals vertically and then adjusted as in Figure 3.2 below [2]. Due to size of the cut-outs and Classification society strength requirements, lugs are fitted and welded on one side.



**Fig. 3.2. Principal block assembly method 1 [2]**

#### **Principal Block Assembly Method 2**

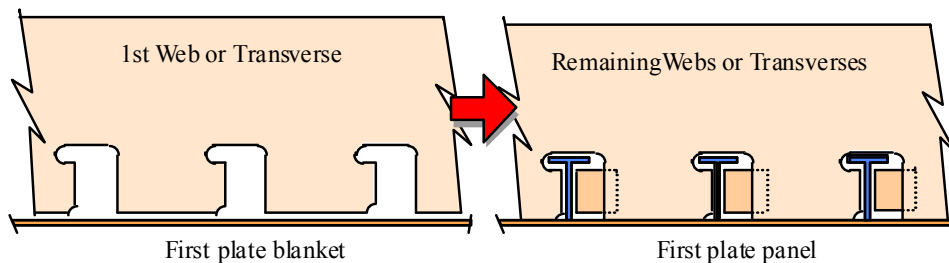
The longitudinals are again fitted and welded to the first plate panel. However, the webs have slits instead of cut-outs which are fitted by pulling them over the longitudinals and then welding them together [2]. There is no need for lugs because of the replacement of cut-outs with slits on the transverses (See Figure 3.3). The elimination of lugs also results in less fitting and welding. This slit process is in compliance to the *lean manufacturing built-in quality* principle. Upon assembly of webs or transverses with slits through the longitudinals, there is no need for further adjustments by fitters as in the cut-out process above, since the clearances are small, only 1.5 mm on either side of the longitudinal [10].



**Fig. 3.3. Principal block assembly method 2 [2]**

#### **Principal Block Assembly Method 3-1**

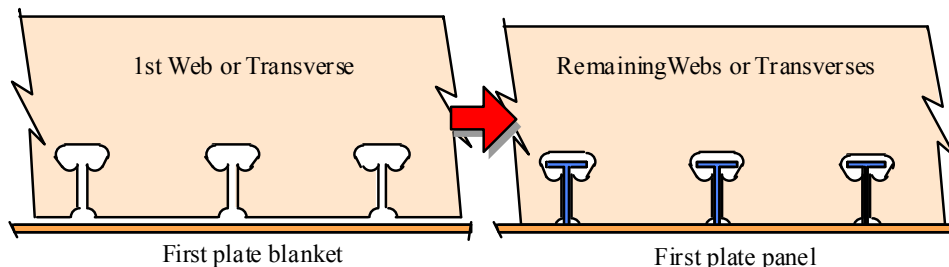
The first web is placed in a holding jig on the “first plate blanket”. Then, longitudinals are placed through the first web cut-outs. The rest of the webs are placed over the longitudinals at the marked positions. Then lugs are fitted and welded to one side of the longitudinals. The complete egg-box structure is tacked and welded together and with the first plate blanket (See Figure 3.4) [2].



**Fig. 3.4. Principal block assembly method 3-1 [2]**

#### **Principal Block Assembly Method 3-2**

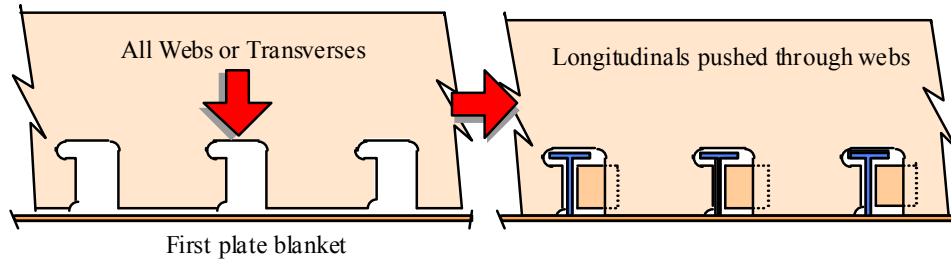
The first web is placed in a holding jig on the “first plate blanket.” The longitudinals are inserted into the slits of the first web. Then, the remaining webs are “pulled over the longitudinals.” The complete egg-box structure is tacked and welded together and with the first plate blanket [2]. Note again that this assembly method also eliminates lugs due to having slits instead of cut-outs in the webs or transverses. It is important to note that the technology for inserting the longitudinals through webs with slits is more demanding than the technology for inserting longitudinals through webs with cut-outs (See Figure 3.5).



**Fig. 3.5. Principal block assembly method 3-2 [2]**

#### **Principal Block Assembly Method 4-1**

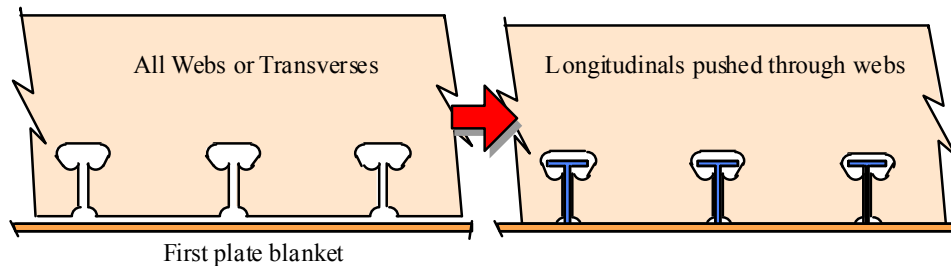
All webs are placed in a holding jig on the “first plate blanket.” All the longitudinals are inserted into the cut-outs of all the webs. The complete structure is tacked and welded together and with the first plate blanket (See Figure 3.6) [2].



**Fig. 3.6. Principal block assembly method 4-1 [2]**

#### **Principal Block Assembly Method 4-2**

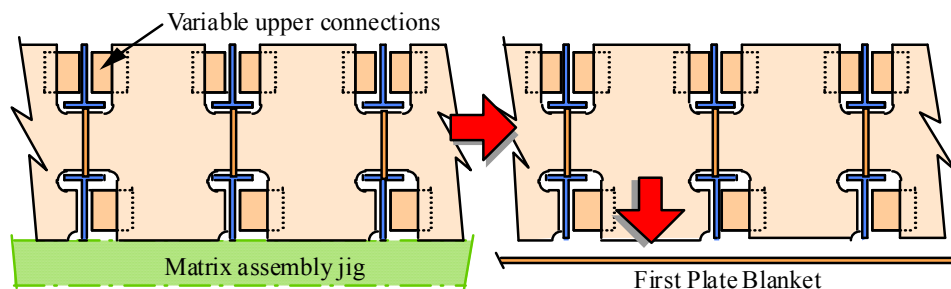
All webs are placed in a holding jig on the “first plate blanket”, resulting in an egg-box structure. The longitudinals are inserted through the slits of all the webs. The complete structure is tacked and welded together (See Figure 3.7) [2].



**Fig. 3.7. Principal block assembly method 4-2 [2]**

#### **Principal Block Assembly Method 5-1**

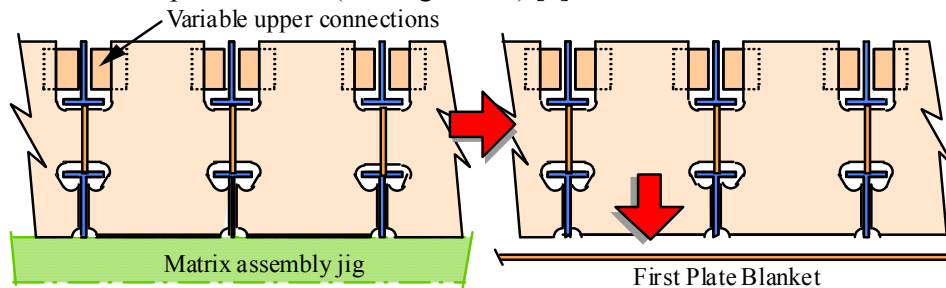
Egg-box structure is assembled in a matrix jig as opposed to a holding jig. First all the longitudinals are fitted into the matrix jig. Then the webs with cut-out type openings are placed over the longitudinals that are securely held down in the matrix jig. The second set of longitudinals are placed over the top part of the webs. Single lugs are fitted on the bottom longitudinals and double lugs on the top longitudinals. The complete structure in the matrix jig is tacked and welded together. Then the entire matrix jig structure is fitted and assembled to the first plate blanket. Finally, the built-up panel is turned over onto the second plate blanket and welded (See Figure 3.8) [2].



**Fig. 3.8. Principal block assembly method 5-1 [2]**

### **Principal Block Assembly Method 5-2**

Again an egg-box structure is assembled in a matrix jig as opposed to a holding jig. The first web is placed into the matrix jig. Then all the bottom longitudinals are fitted through the first web with slits. The remaining webs also with slit type openings are pulled over the longitudinals that are securely held down in the matrix jig. The top set of longitudinals are placed over the top part of the webs. Double lugs are fitted on the top longitudinals. The complete structure is welded together in the matrix jig. Then the internal structure is fitted and welded with the first plate blanket (See Figure 3.9) [2].



**Fig. 3.9. Principal block assembly method 5-2 [2]**

### **3.3. GENERATION AND EVALUATION OF ASSEMBLY OPTIONS FOR PRINCIPAL BLOCK ASSEMBLY METHODS**

The above principle block assembly methods can all be subdivided into various options. These options include considering the bulb plate or holland profile (HP) longitudinals which are the most common longitudinals used in shipyards due to their strength per mass benefits. The following figures 3.10 to 3.49 illustrate the block assembly methods adjusted for bulb profiles that are commonly used by shipyards building commercial vessels. The advantages of the bulb profile are that the dimensions and weight and strength characteristics are better than that of T-bars or L bars. Therefore, they are well suited for shipyards that want to enhance their DFP and *lean manufacturing* activities.

The 56 different block assembly methods illustrated above are used in different shipyards around the world. Frequently, the block assembly method to be used at individual shipyards is determined at the workshop level, often by production foremen. Whereas the foremen have experience in assembly techniques, the purpose of the *design for production* methodology is to bring production decisions such as block assembly into the realm of scientific decision making and strategical planning in which the shipyard management is the main driver for analysis and improvement, because without this the foremen of individual shops will continue to do things the way they know, which often is not the most productive method available for the shipyard.

The purpose for evaluating the 56 various block assembly options is in order to determine which one is optimal for the present state technology level of the shipyard and which method or methods the shipyard management should be developing towards in the future. In order to determine the appropriateness or the production friendliness of the different combinations of assembling blocks, it is necessary to use a couple of evaluation methods. The first evaluation method involves the use of production engineering criteria appropriate for block assembly [2]:

- “maximization of downhand fitting,
- maximization of downhand and automatic welding processes,

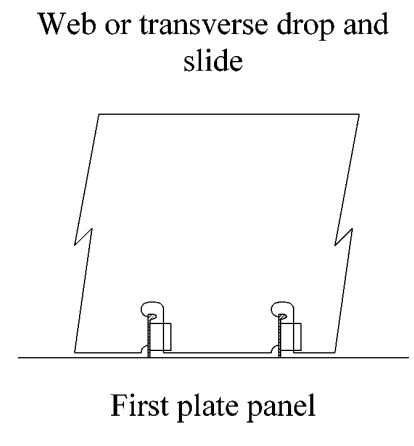
- ease of access to joints during the assembly process,
- self supporting interim products,
- minimization of turning during the assembly process,
- simplification of connections and reduced variety,
- minimization of joint length and reduced number of parts,
- self aligning interim products with reduced need for high levels of accuracy,
- maximization of automated assembly lines, and
- maximization of current facilities and applicable to the current technology level,”
- classification society approval

The compliance of each block assembly method to each production criterion can be rated both for two additional categories of simplification and standardization. For instance the simplification category implies whether it is “the simplest method for achieving the production engineering criteria”. The rating under the standardization category includes whether it may be performed using the shipyards “standard processes / facilities or whether new specialized jigs, equipment or facilities would be required” [2]. See tables 3.1 to 3.56. Each criterion and each sub-category can be identified as either compliant or non-compliant. To make it more practical, the rating is either one or zero as in computer binary code. One represents a positive rating and zero represents a negative rating.

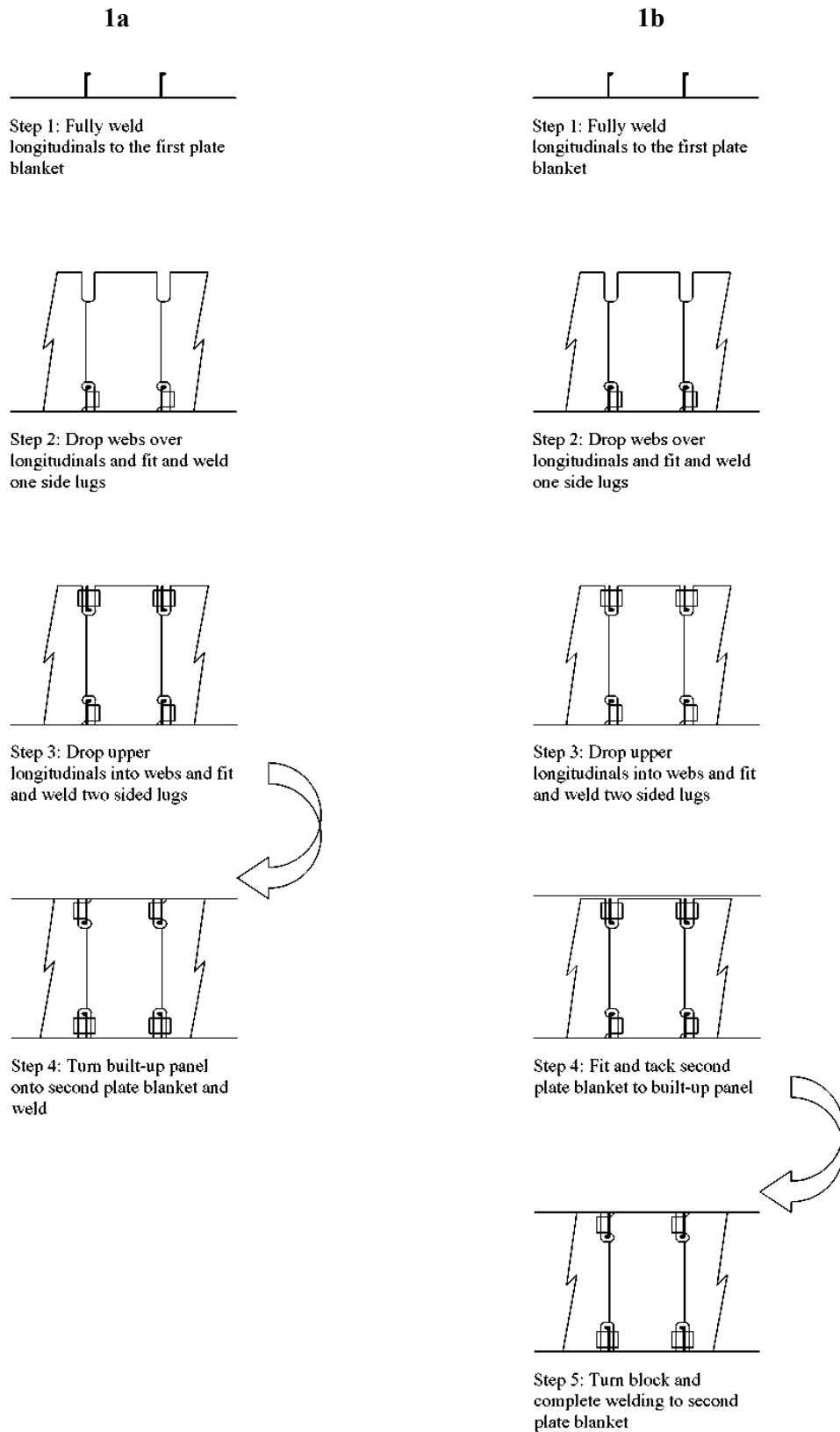
The second method for evaluating the block assembly methods “was to compare the work content in terms of weld length and man-hours” [2]. These criteria are all in compliance with *design for production* and *lean manufacturing* principles because they strive to simplify and reduce the waste of unnecessary motions and overprocessing in producing the interim block. The use of slits or slots instead of cut-outs through the transverse members members will definitely reduce the weld length. However this change in production detail also requires changes in the block assembly method and technology, since most shipyards do not possess the accurate technology level for this slit block assembly method. Therefore it is necessary to analyze this deeper later on in the dissertation.

#### **Assembly options for principal block assembly method 1**

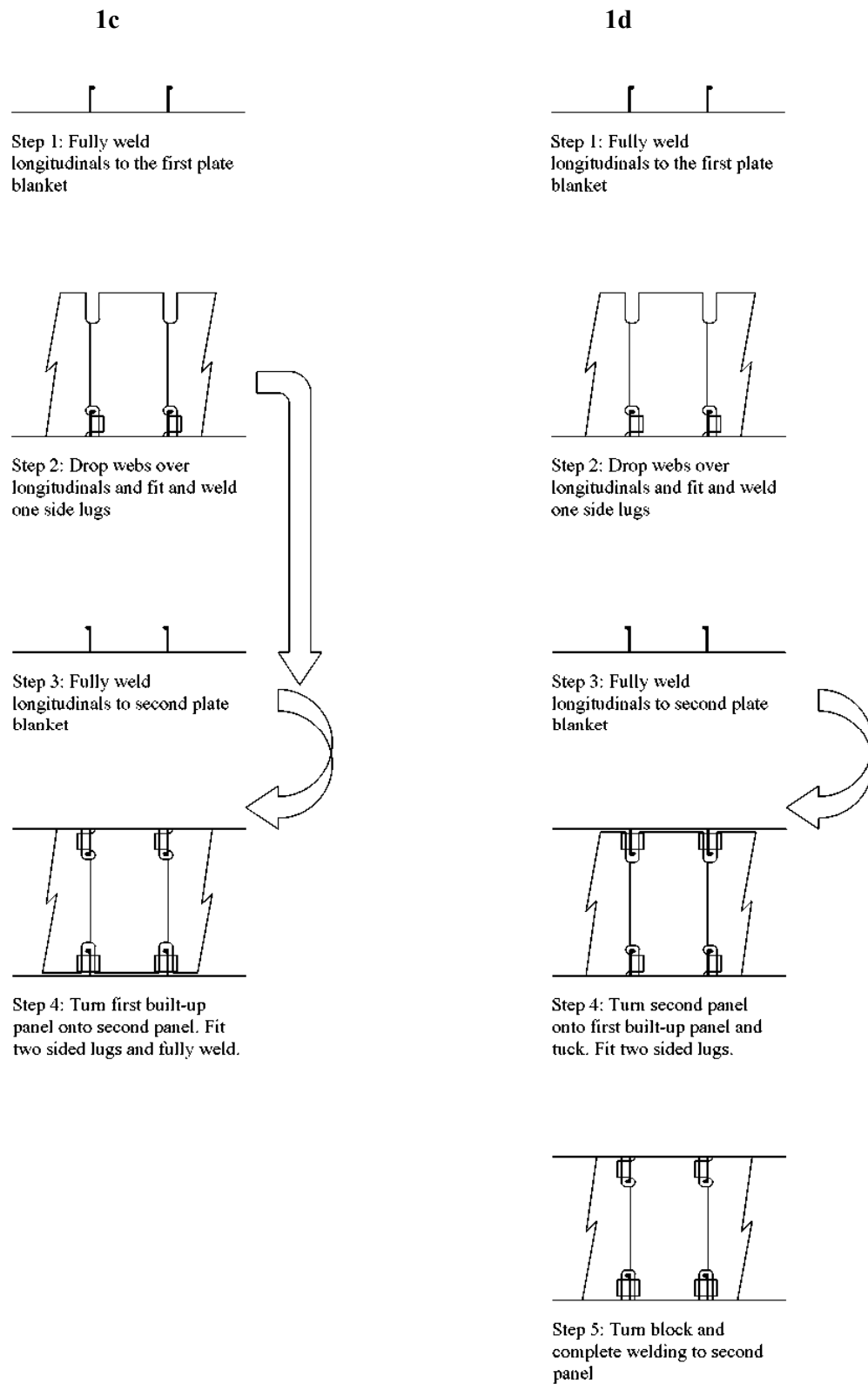
Figure 3.10 shows the principal block assembly method 1 adapted for bulb plate longitudinals, while figures 3.11 to 3.14 illustrate the seven options. The complementary option evaluation tables 3.1 to 3.7 are included as well.



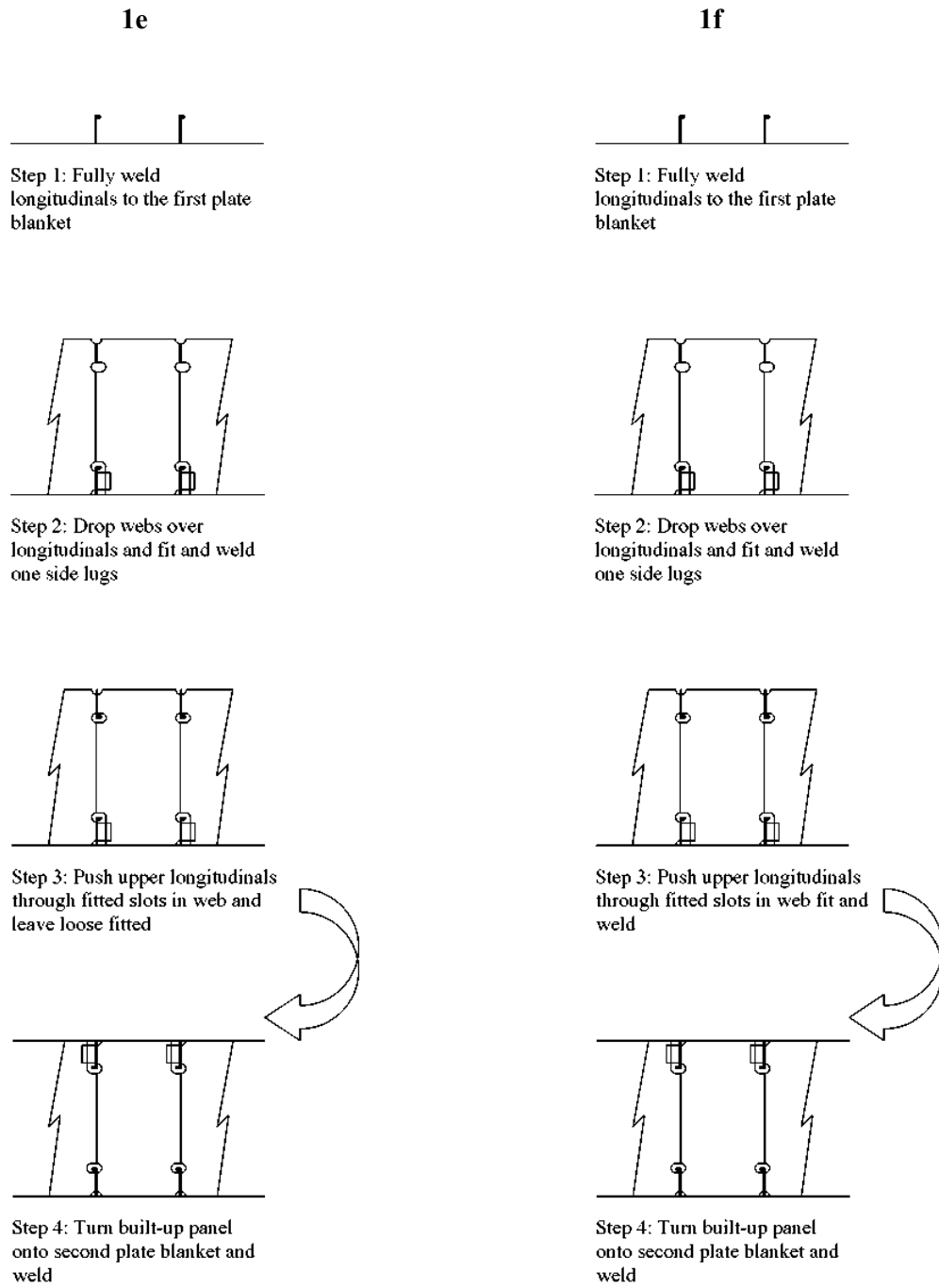
**Fig. 3.10. Principal block assembly method 1 [2], [30]**



**Fig. 3.11. Block assembly methods 1a and 1b [2], [30]**

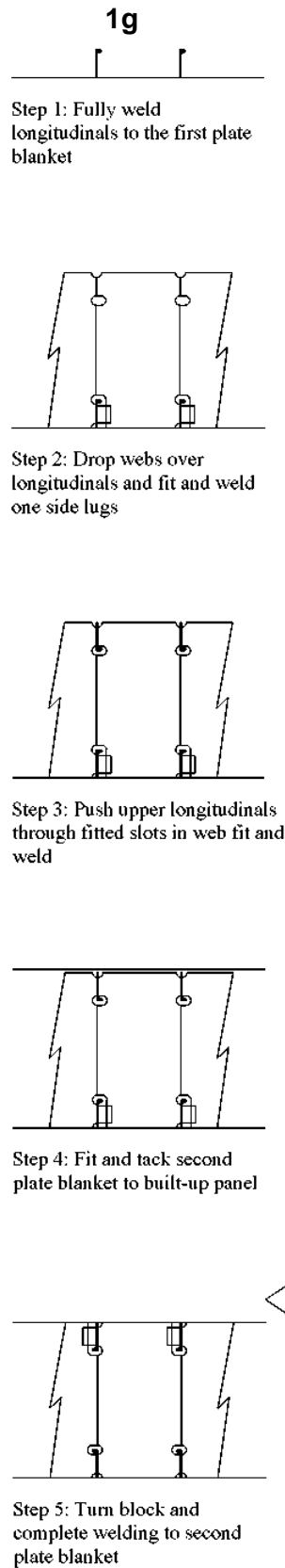


**Fig. 3.12. Block assembly methods 1c and 1d [2], [30]**



**Fig. 3.13. Block assembly methods 1e and 1f [2], [30]**





**Fig. 3.14. Block assembly method 1g [2], [30]**

**Tab. 3.1. Assembly option evaluation for block assembly method 1-a [2], [30]**

No.	Engineering Criteria	Method 1-a	
1	Maximize downhand and automatic welding	Overhead welding of longitudinals and lugs to webs.	
	Criteria assessment	Simplification 0	Standardization 0
2	Easy access to joints during assembly	Staging required at each web to fit longitudinals and lugs.	
	Criteria assessment	Simplification 0	Standardization 0
3	Self supporting interim products	No	
	Criteria assessment	Simplification 0	Standardization 0
4	Minimize turning during assembly	One assembly turn of built up 1st panel onto second plate panel.	
	Criteria assessment	Simplification 1	Standardization 1
5	Simplify connections. Minimize variety.	Cut outs with lugs top and bottom.	
	Criteria assessment	Simplification 1	Standardization 1
6	Maximize downhand fitting	Overhead fitting of 2 <sup>nd</sup> panel longitudinals and lugs into web cut outs.	
	Criteria assessment	Simplification 0	Standardization 0
7	Minimize joint length. Reduce no. of parts.	For a typical longitudinal bulb flat HP 340*14 on the parallel mid-body. One-sided lug: 950mm weld length; Double sided lug: 1400 mm weld length.	
	Criteria assessment	Simplification 0	Standardization 1
8	Self aligning interim products. Reduce need for high accuracy levels.	Web alignment at single lug cut out. Minimum accuracy needed for fitting webs to first panel.	
	Criteria assessment	Simplification 0	Standardization 1
9	Maximize the use of automated assembly lines	Uses automatic twin fillet welding of longitudinals on 1st panels only	
	Criteria assessment	Simplification 0	Standardization 0
10	Maximize current facilities. Applicable to current technology level.	Requires no technology development. Does not maximize automatic twin fillet welding.	
	Criteria assessment	Simplification 0	Standardization 0
11	Classification approval.	Within current technology level, all details approved.	
	Criteria assessment	Simplification 1	Standardization 1
<b>Total</b>		<b>3</b>	<b>5</b>

**Tab. 3.2. Assembly option evaluation for block assembly method 1-b [2], [30]**

No.	Engineering Criteria	Method 1-b	
1	Maximize downhand and automatic welding	Overhead welding of upper longitudinals to webs. Overhead tacking of plate blanket to built up panel.	
	Criteria assessment	Simplification 0	Standardization 0
2	Easy access to joints during assembly	Staging required at each web to fit longitudinals and lugs. Staging required to tack plate blanket to built-up panel.	
	Criteria assessment	Simplification 0	Standardization 0
3	Self supporting interim products	No	
	Criteria assessment	Simplification 0	Standardization 0
4	Minimize turning during assembly	One turn of 2 <sup>nd</sup> plate blanket onto 1st built up panel. One turn of full block to weld 2 <sup>nd</sup> plate blanket.	
	Criteria assessment	Simplification 0	Standardization 0
5	Simplify connections. Minimize variety.	Cut outs with lugs top and bottom.	
	Criteria assessment	Simplification 1	Standardization 1
6	Maximize downhand fitting	Overhead fitting of 2 <sup>nd</sup> panel longitudinals and lugs into web cut outs. Overhead fitting of 2 <sup>nd</sup> plate blanket to first built up panel.	
	Criteria assessment	Simplification 0	Standardization 0
7	Minimize joint length. Reduce no. of parts.	For a typical longitudinal bulb flat HP 340*14 on the parallel mid-body. One-sided lug: 950mm weld length; Double sided lug: 1400 mm weld length.	
	Criteria assessment	Simplification 0	Standardization 1
8	Self aligning interim products. Reduce need for high accuracy levels.	Web alignment at single lug cut out. Minimum accuracy needed for fitting webs to first panel.	
	Criteria assessment	Simplification 0	Standardization 1
9	Maximize the use of automated assembly lines	Uses automatic twin fillet welding of longitudinals on 1st panel only.	
	Criteria assessment	Simplification 0	Standardization 0
10	Maximize current facilities. Applicable to current technology level.	Requires no technology development. Does not maximize automatic twin fillet welding.	
	Criteria assessment	Simplification 0	Standardization 0
11	Classification approval.	Within current technology level, all details approved.	
	Criteria assessment	Simplification 1	Standardization 1
<b>Total</b>		<b>2</b>	<b>4</b>

**Tab. 3.3. Assembly option evaluation for block assembly method 1-c [2], [30]**

No.	Engineering Criteria	Method 1-c	
1	Maximize downhand and automatic welding	No overhead welding.	
	Criteria assessment	Simplification 1	Standardization 1
2	Easy access to joints during assembly	Simplified access to assembly joints.	
	Criteria assessment	Simplification 1	Standardization 1
3	Self supporting interim products	Yes	
	Criteria assessment	Simplification 1	Standardization 1
4	Minimize turning during assembly	One assembly turn of built up 1st panel onto second plate panel.	
	Criteria assessment	Simplification 1	Standardization 1
5	Simplify connections. Minimize variety.	Cut outs with lugs top and bottom.	
	Criteria assessment	Simplification 1	Standardization 1
6	Maximize downhand fitting	All downhand fitting.	
	Criteria assessment	Simplification 1	Standardization 1
7	Minimize joint length. Reduce no. of parts.	For a typical longitudinal bulb flat HP 340*14 on the parallel mid-body. One-sided lug: 950mm weld length; Double sided lug: 1400 mm weld length.	
	Criteria assessment	Simplification 0	Standardization 1
8	Self aligning interim products. Reduce need for high accuracy levels.	Web alignment at single lug cut out. Minimum accuracy needed for fitting webs to first panel and longls to 2nd panel.	
	Criteria assessment	Simplification 1	Standardization 1
9	Maximize the use of automated assemble lines	Uses automatic twin fillet welding of longitudinals on 1st and 2nd panels.	
	Criteria assessment	Simplification 1	Standardization 1
10	Maximize current facilities. Applicable to current technology level.	Requires no technology development. Does not maximize automatic twin fillet welding.	
	Criteria assessment	Simplification 1	Standardization 1
11	Classification approval.	Within current technology level, all details approved.	
	Criteria assessment	Simplification 1	Standardization 1
<b>Total</b>		<b>10</b>	<b>11</b>

**Tab. 3.4. Assembly option evaluation for block assembly method 1-d [2], [30]**

No.	Engineering Criteria	Method 1-d	
1	Maximize downhand and automatic welding	Overhead tacking of 2 <sup>nd</sup> plate panel to 1 <sup>st</sup> built up panel.	
	Criteria assessment	Simplification 0	Standardization 0
2	Easy access to joints during assembly	Staging required at webs to tack 2 <sup>nd</sup> panel to 1 <sup>st</sup> built up panel.	
	Criteria assessment	Simplification 0	Standardization 0
3	Self supporting interim products	Yes	
	Criteria assessment	Simplification 0	Standardization 1
4	Minimize turning during assembly	One turn of 2 <sup>nd</sup> plate blanket onto 1 <sup>st</sup> built up panel. One turn of full block to weld 2 <sup>nd</sup> plate blanket.	
	Criteria assessment	Simplification 0	Standardization 0
5	Simplify connections. Minimize variety.	Cut outs with lugs top and bottom.	
	Criteria assessment	Simplification 1	Standardization 1
6	Maximize downhand fitting	Overhead fitting of 2 <sup>nd</sup> plate blanket and longitudinal lugs to 1 <sup>st</sup> built up panel.	
	Criteria assessment	Simplification 0	Standardization 0
7	Minimize joint length. Reduce no. of parts.	For a typical longitudinal bulb flat HP 340*14 on the parallel mid-body. One-sided lug: 950mm weld length; Double sided lug: 1400 mm weld length.	
	Criteria assessment	Simplification 0	Standardization 1
8	Self aligning interim products. Reduce need for high accuracy levels.	Web alignment at single lug cut out. Minimum accuracy needed for fitting webs to first panel and longls to 2nd panel.	
	Criteria assessment	Simplification 0	Standardization 0
9	Maximize the use of automated assemble lines	Uses automatic twin fillet welding of longitudinals on 1st and 2nd panels.	
	Criteria assessment	Simplification 1	Standardization 1
10	Maximize current facilities. Applicable to current technology level.	Requires no technology development. Does not maximize automatic twin fillet welding.	
	Criteria assessment	Simplification 1	Standardization 1
11	Classification approval.	Within current technology level, all details approved.	
	Criteria assessment	Simplification 1	Standardization 1
<b>Total</b>		<b>4</b>	<b>6</b>

**Tab. 3.5. Assembly option evaluation for block assembly method 1-e [2], [30]**

No.	Engineering Criteria	Method 1-e	
1	Maximize downhand and automatic welding	No overhead welding.	
	Criteria assessment	Simplification 1	Standardization 1
2	Easy access to joints during assembly	Staging required to access upper longls during slotting through webs.	
	Criteria assessment	Simplification 0	Standardization 0
3	Self supporting interim products	No	
	Criteria assessment	Simplification 0	Standardization 0
4	Minimize turning during assembly	One assembly turn of 1 <sup>st</sup> built up panel onto 2 <sup>nd</sup> plate blanket.	
	Criteria assessment	Simplification 1	Standardization 1
5	Simplify connections. Minimize variety.	Cut outs with lugs top and bottom. Fitted slots at the bottom.	
	Criteria assessment	Simplification 0	Standardization 0
6	Maximize downhand fitting	All downhand fitting.	
	Criteria assessment	Simplification 1	Standardization 1
7	Minimize joint length. Reduce no. of parts.	For a typical longitudinal bulb flat HP 340*14 on the parallel mid-body. Single lug: 950mm weld length; Fitted slot: 500 mm weld length.	
	Criteria assessment	Simplification 1	Standardization 0
8	Self aligning interim products. Reduce need for high accuracy levels.	Web alignment at single lug cut out. Minimum accuracy needed for fitting webs to first panel. High accuracy for slots.	
	Criteria assessment	Simplification 0	Standardization 0
9	Maximize the use of automated assemble lines	Uses automatic twin fillet welding of longitudinals on 1st panel only.	
	Criteria assessment	Simplification 1	Standardization 1
10	Maximize current facilities. Applicable to current technology level.	Requires significant technology and accuracy development. Requires upper longitudinal slotting equipment.	
	Criteria assessment	Simplification 0	Standardization 0
11	Classification approval.	Requires design and approval of longitudinal slots.	
	Criteria assessment	Simplification 0	Standardization 0
<b>Total</b>		<b>4</b>	<b>3</b>

**Tab. 3.6. Assembly option evaluation for block assembly method 1-f [2] [30]**

No.	Engineering Criteria	Method 1-f	
1	Maximize downhand and automatic welding	Overhead welding of longitudinals into web slots.	
	Criteria assessment	Simplification 0	Standardization 0
2	Easy access to joints during assembly	Staging required to weld upper longls into slots in the webs.	
	Criteria assessment	Simplification 0	Standardization 0
3	Self supporting interim products	No	
	Criteria assessment	Simplification 0	Standardization 0
4	Minimize turning during assembly	One assembly turn of 1 <sup>st</sup> built up panel onto 2 <sup>nd</sup> plate blanket.	
	Criteria assessment	Simplification 1	Standardization 1
5	Simplify connections. Minimize variety.	Cut outs with lugs top and bottom. Fitted slots at the bottom.	
	Criteria assessment	Simplification 0	Standardization 0
6	Maximize downhand fitting	Overhead fitting of longitudinals in slots in webs.	
	Criteria assessment	Simplification 0	Standardization 0
7	Minimize joint length. Reduce no. of parts.	For a typical longitudinal bulb flat HP 340*14 on the parallel mid-body. Single lug: 950mm weld length; Fitted slot: 500 mm weld length.	
	Criteria assessment	Simplification 1	Standardization 0
8	Self aligning interim products. Reduce need for high accuracy levels.	Web alignment at single lug cut out. Minimum accuracy needed for fitting webs to first panel. High accuracy for slots.	
	Criteria assessment	Simplification 0	Standardization 0
9	Maximize the use of automated assemble lines	Uses automatic twin fillet welding of longitudinals on 1st panel only.	
	Criteria assessment	Simplification 0	Standardization 0
10	Maximize current facilities. Applicable to current technology level.	Requires significant technology and accuracy development. Requires upper longitudinal slotting equipment.	
	Criteria assessment	Simplification 0	Standardization 0
11	Classification approval.	Requires design and approval of longitudinal slots.	
	Criteria assessment	Simplification 0	Standardization 0
<b>Total</b>		<b>2</b>	<b>1</b>

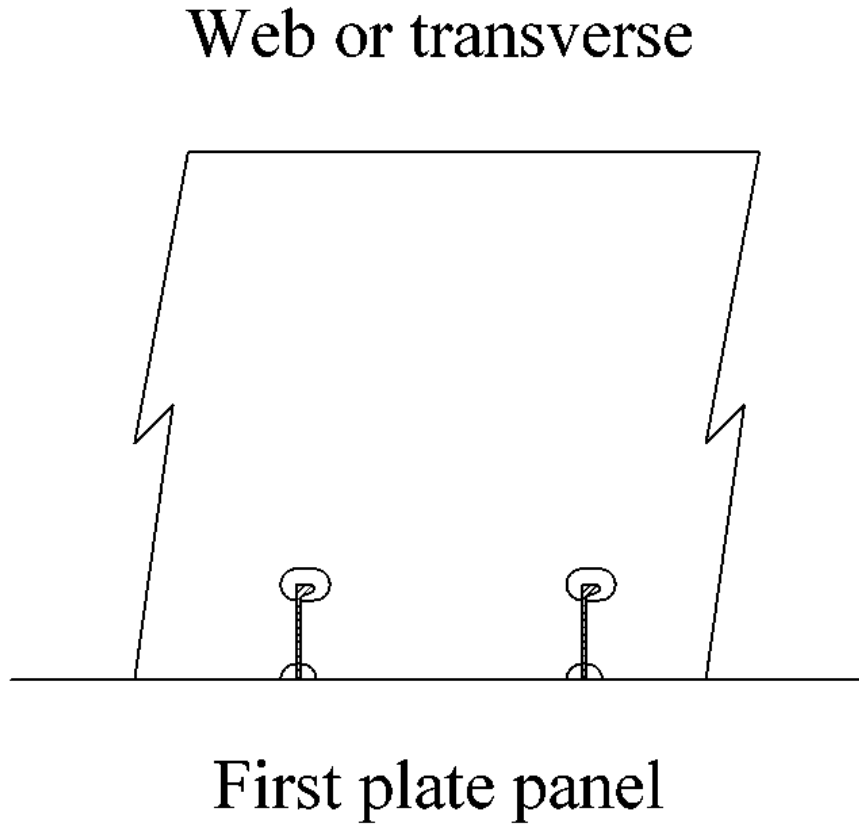
**Tab. 3.7. Assembly option evaluation for block assembly method 1-g [2], [30]**

No.	Engineering Criteria	Method 1-g	
1	Maximize downhand and automatic welding	Overhead welding of longitudinals into web slots. Overhead tacking of 2 <sup>nd</sup> plate blanket to 1 <sup>st</sup> built up panel.	
	Criteria assessment	Simplification 0	Standardization 0
2	Easy access to joints during assembly	Staging required to weld upper longls into slots in the webs. Staging required to tack 2 <sup>nd</sup> plate blanket to first built up panel.	
	Criteria assessment	Simplification 0	Standardization 0
3	Self supporting interim products	No	
	Criteria assessment	Simplification 0	Standardization 0
4	Minimize turning during assembly	One turn of 2 <sup>nd</sup> plate blanket onto 1 <sup>st</sup> built up panel. One turn of full block to weld 2 <sup>nd</sup> plate blanket.	
	Criteria assessment	Simplification 0	Standardization 0
5	Simplify connections. Minimize variety.	Cut outs with lugs top and bottom. Fitted slots at the bottom.	
	Criteria assessment	Simplification 0	Standardization 0
6	Maximize downhand fitting	Overhead fitting of longitudinals in slots in webs. Overhead fitting of 2 <sup>nd</sup> plate blanket to 1 <sup>st</sup> built up panel.	
	Criteria assessment	Simplification 0	Standardization 0
7	Minimize joint length. Reduce no. of parts.	For a typical longitudinal bulb flat HP 340*14 on the parallel mid-body. Single lug: 950mm weld length; Fitted slot: 500 mm weld length.	
	Criteria assessment	Simplification 1	Standardization 0
8	Self aligning interim products. Reduce need for high accuracy levels.	Web alignment at single lug cut out. Minimum accuracy needed for fitting webs to first panel. High accuracy for slots.	
	Criteria assessment	Simplification 0	Standardization 0
9	Maximize the use of automated assemble lines	Uses automatic twin fillet welding of longitudinals on 1st panel only.	
	Criteria assessment	Simplification 0	Standardization 0
10	Maximize current facilities. Applicable to current technology level.	Requires significant technology and accuracy development. Requires upper longitudinal slotting equipment.	
	Criteria assessment	Simplification 0	Standardization 0
11	Classification approval.	Requires design and approval of longitudinal slots.	
	Criteria assessment	Simplification 0	Standardization 0
<b>Total</b>		<b>1</b>	<b>0</b>



**Assembly options for principal block assembly method 2**

Figure 3.15 shows the principal block assembly method 2 adapted for bulb plate longitudinals, while figures 3.15 to 3.19 illustrate the seven options. The complementary option evaluation tables 3.8 to 3.14 are included as well.



**Fig. 3.15. Principal block assembly method 2 [2], [30]**

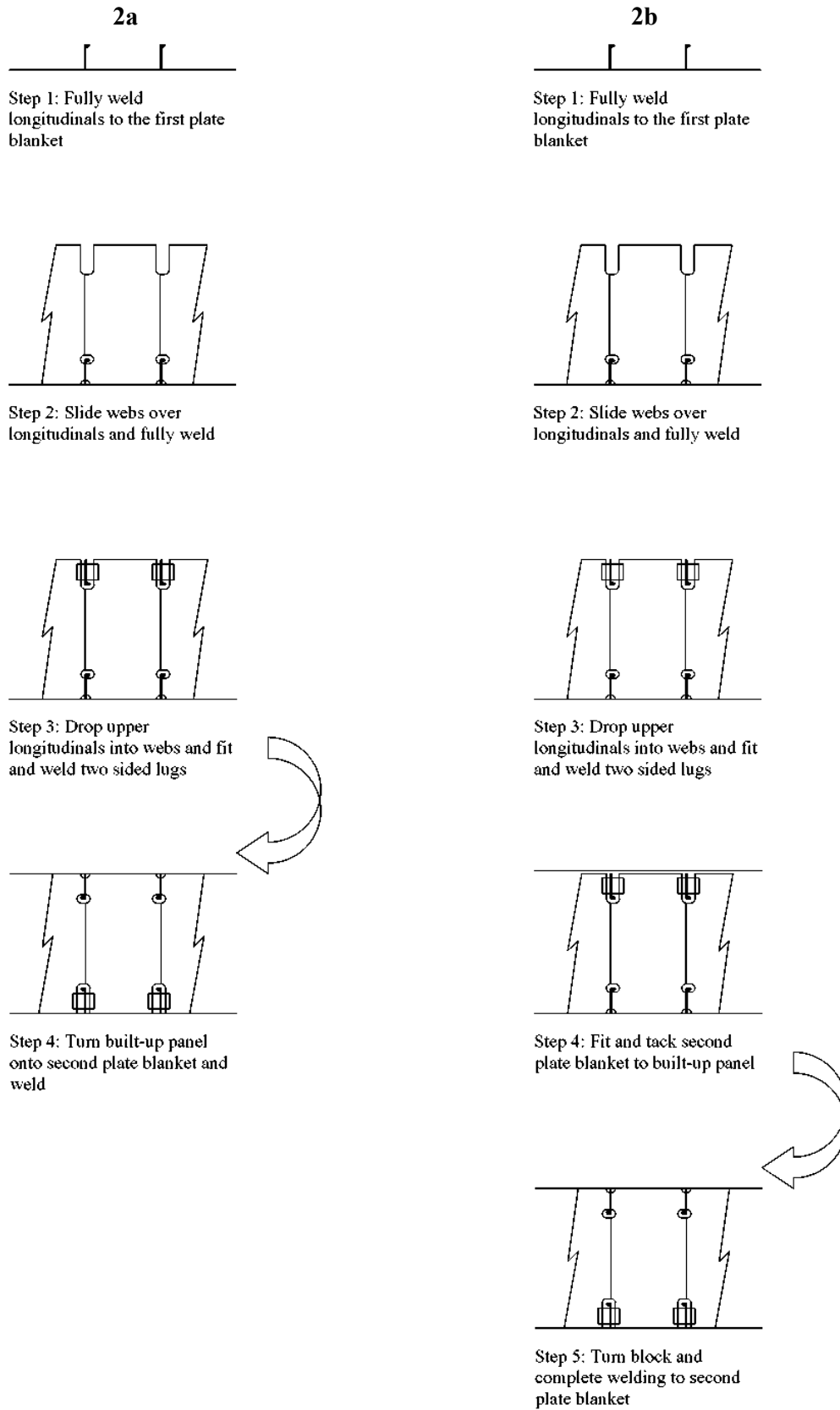
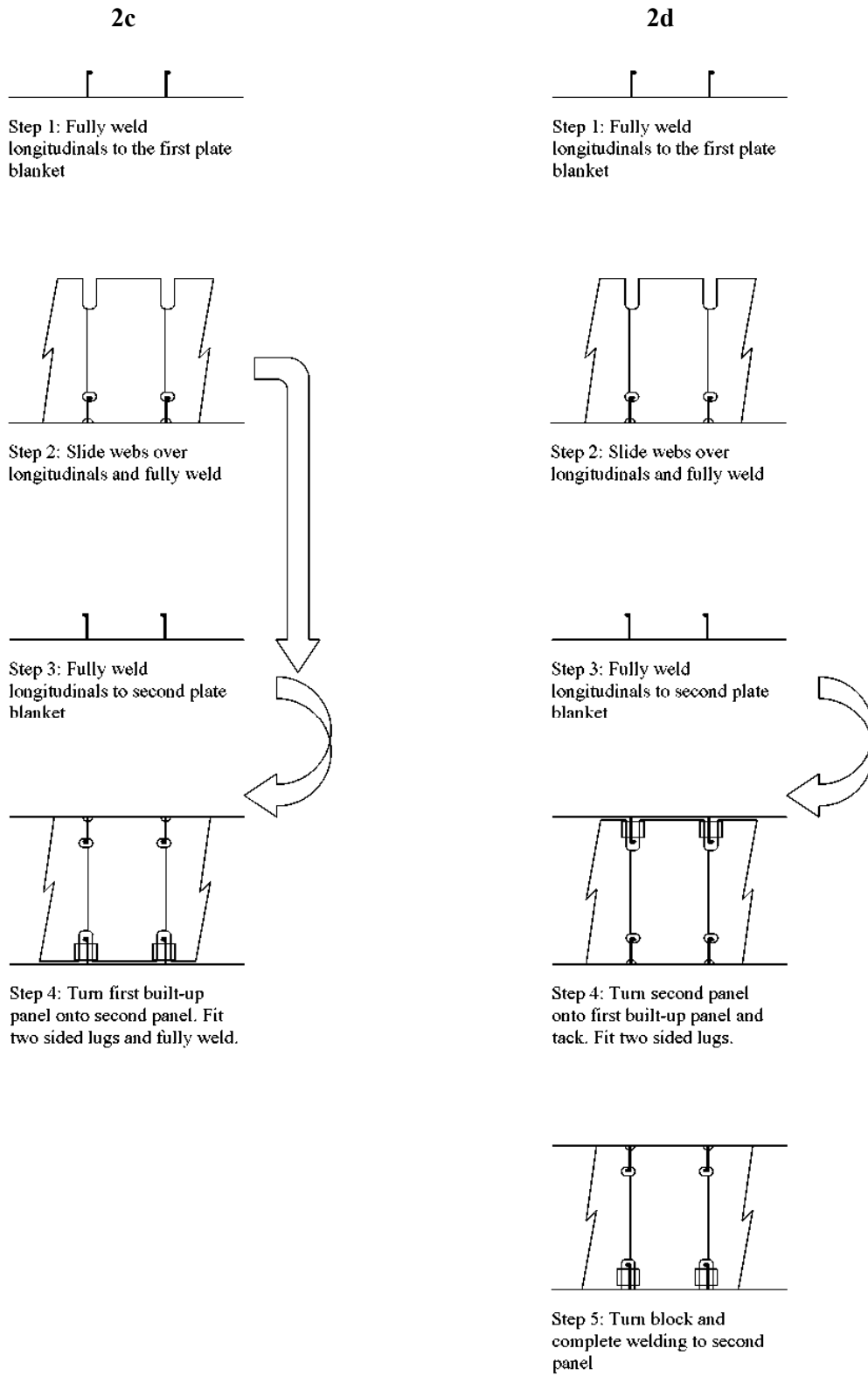
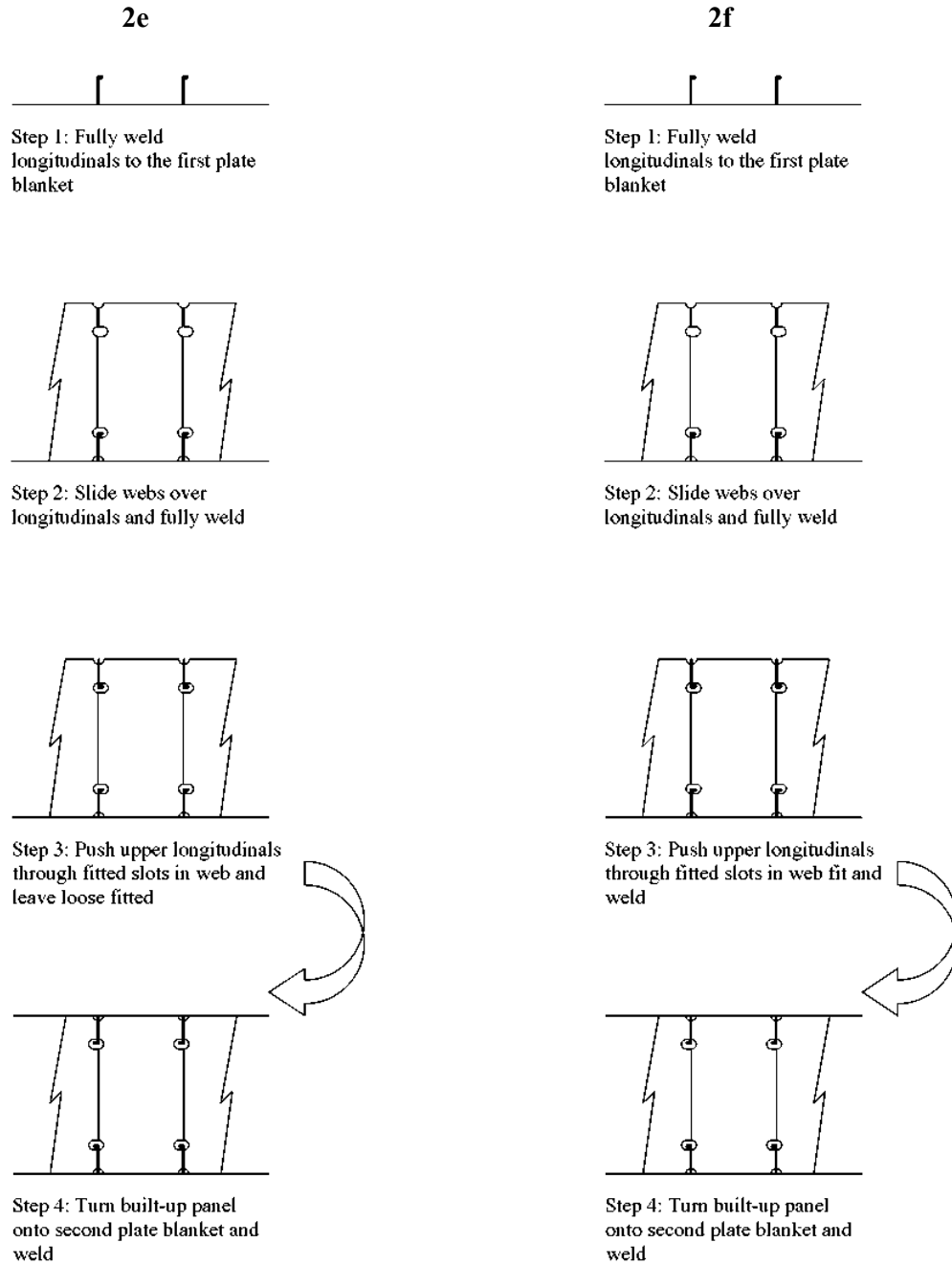


Fig. 3.16. Block assembly methods 2a and 2b [2], [30]



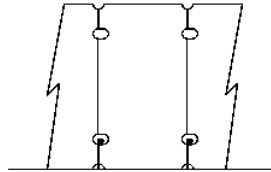
**Fig. 3.17. Block assembly methods 2c and 2d [2], [30]**



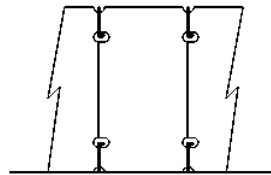
**Fig. 3.18. Block assembly methods 2e and 2f [2], [30]**

**2g**

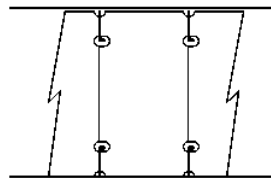
Step 1: Fully weld  
longitudinals to the first plate  
blanket



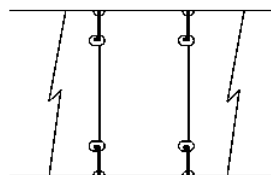
Step 2: Slide webs over  
longitudinals and fully weld



Step 3: Push upper longitudinals  
through fitted slots in web fit and  
weld



Step 4: Fit and tack second  
plate blanket to built-up panel



Step 5: Turn block and  
complete welding to second  
plate blanket

**Fig. 3.19. Block assembly method 2g [2], [30]**

**Tab. 3.8. Assembly option evaluation for block assembly method 2-a [2], [30]**

No.	Engineering Criteria	Method 2a	
1	Maximize downhand and automatic welding	Overhead welding of upper longitudinals to webs.	
	Criteria assessment	Simplification 0	Standardization 0
2	Easy access to joints during assembly	Staging required at each web to fit longitudinals and lugs.	
	Criteria assessment	Simplification 0	Standardization 0
3	Self supporting interim products	No	
	Criteria assessment	Simplification 0	Standardization 0
4	Minimize turning during assembly	One assembly turn of 1 <sup>st</sup> built up panel onto 2 <sup>nd</sup> plate blanket.	
	Criteria assessment	Simplification 1	Standardization 1
5	Simplify connections. Minimize variety.	Fitted slots for longitudinals on 1st panel. Cut outs with lugs both sides on 2 <sup>nd</sup> panel.	
	Criteria assessment	Simplification 0	Standardization 0
6	Maximize downhand fitting	Overhead fitting of 2 <sup>nd</sup> panel longitudinals and lugs into web cut-outs.	
	Criteria assessment	Simplification 0	Standardization 0
7	Minimize joint length. Reduce no. of parts.	For a typical longitudinal bulb flat HP 340*14 on the parallel mid-body. Single lug: 950mm weld length; Fitted slot: 500 mm weld length.	
	Criteria assessment	Simplification 0	Standardization 0
8	Self aligning interim products. Reduce need for high accuracy levels.	Very high level of accuracy required to fully weld longitudinals and slide webs. No self alignment with open cut outs on 2nd panel.	
	Criteria assessment	Simplification 0	Standardization 0
9	Maximize the use of automated assembly lines	Uses automatic twin fillet welding of longitudinals on 1st panel only.	
	Criteria assessment	Simplification 0	Standardization 0
10	Maximize current facilities. Applicable to current technology level.	Requires significant accuracy control development. Requires specialized web pulling equipment.	
	Criteria assessment	Simplification 0	Standardization 0
11	Classification approval.	Requires design and approval of longitudinal slots.	
	Criteria assessment	Simplification 0	Standardization 0
<b>Total</b>		<b>1</b>	<b>1</b>

**Tab. 3.9. Assembly option evaluation for block assembly method 2-b [2], [30]**

No.	Engineering Criteria	Method 2-b	
1	Maximize downhand and automatic welding	Overhead welding of upper longitudinals to webs. Overhead tacking of plate blanket to built up panel.	
	Criteria assessment	Simplification 0	Standardization 0
2	Easy access to joints during assembly	Staging required at each web to fit longitudinals and lugs. Staging required to tack plate blanket to built up panel.	
	Criteria assessment	Simplification 0	Standardization 0
3	Self supporting interim products	No	
	Criteria assessment	Simplification 0	Standardization 0
4	Minimize turning during assembly	One turn of 2 <sup>nd</sup> plate blanket onto 1 <sup>st</sup> built up panel. One turn of full block to weld 2 <sup>nd</sup> plate blanket.	
	Criteria assessment	Simplification 0	Standardization 0
5	Simplify connections. Minimize variety.	Fitted slots for longitudinals on 1st panel. Cut outs with lugs both sides on 2 <sup>nd</sup> panel.	
	Criteria assessment	Simplification 0	Standardization 0
6	Maximize downhand fitting	Overhead fitting of 2 <sup>nd</sup> panel longitudinals and lugs into web cut-outs. Overhead fitting of 2 <sup>nd</sup> plate blanket to 1 <sup>st</sup> built up panel.	
	Criteria assessment	Simplification 0	Standardization 0
7	Minimize joint length. Reduce no. of parts.	For a typical longitudinal bulb flat HP 340*14 on the parallel mid-body. Single lug: 950mm weld length; Fitted slot: 500 mm weld length.	
	Criteria assessment	Simplification 0	Standardization 0
8	Self aligning interim products. Reduce need for high accuracy levels.	Very high level of accuracy required to fully weld longitudinals and slide webs. No self alignment with open cut outs on 2nd panel.	
	Criteria assessment	Simplification 0	Standardization 0
9	Maximize the use of automated assembly lines	Uses automatic twin fillet welding of longitudinals on 1st panel only.	
	Criteria assessment	Simplification 0	Standardization 0
10	Maximize current facilities. Applicable to current technology level.	Requires significant accuracy control development. Requires specialized web pulling equipment.	
	Criteria assessment	Simplification 0	Standardization 0
11	Classification approval.	Requires design and approval of longitudinal slots.	
	Criteria assessment	Simplification 0	Standardization 0
<b>Total</b>		<b>0</b>	<b>0</b>

**Tab. 3.10. Assembly option evaluation for block assembly method 2-c [2], [30]**

No.	Engineering Criteria	Method 2-c	
1	Maximize downhand and automatic welding	No overhead welding.	
	Criteria assessment	Simplification 1	Standardization 1
2	Easy access to joints during assembly	Simplified access to assembly joints.	
	Criteria assessment	Simplification 1	Standardization 1
3	Self supporting interim products	Yes	
	Criteria assessment	Simplification 1	Standardization 1
4	Minimize turning during assembly	One assembly turn of built up 1st panel onto second plate panel.	
	Criteria assessment	Simplification 1	Standardization 1
5	Simplify connections. Minimize variety.	Fitted slots for longitudinals on first 1st panel. Cut outs with lugs both sides on 2 <sup>nd</sup> panel.	
	Criteria assessment	Simplification 0	Standardization 0
6	Maximize downhand fitting	All downhand fitting.	
	Criteria assessment	Simplification 1	Standardization 1
7	Minimize joint length. Reduce no. of parts.	For a typical longitudinal bulb flat HP 340*14 on the parallel mid-body. Single lug: 950mm weld length; Fitted slot: 500 mm weld length.	
	Criteria assessment	Simplification 0	Standardization 0
8	Self aligning interim products. Reduce need for high accuracy levels.	Very high level of accuracy required to fully weld longitudinals and slide webs. No self alignment with open cut outs on 2nd panel.	
	Criteria assessment	Simplification 0	Standardization 0
9	Maximize the use of automated assembly lines	Uses automatic twin fillet welding of longitudinals on 1st and 2nd panels.	
	Criteria assessment	Simplification 1	Standardization 1
10	Maximize current facilities. Applicable to current technology level.	Requires significant accuracy control development. Requires specialized web pulling equipment.	
	Criteria assessment	Simplification 0	Standardization 0
11	Classification approval.	Requires design and approval of longitudinal slots.	
	Criteria assessment	Simplification 0	Standardization 0
<b>Total</b>		<b>6</b>	<b>6</b>



**Tab. 3.11. Assembly option evaluation for block assembly method 2-d [2], [30]**

No.	Engineering Criteria	Method 2-d	
1	Maximize downhand and automatic welding	Overhead tacking of 2 <sup>nd</sup> plate panel to 1 <sup>st</sup> built up panel.	
	Criteria assessment	Simplification 0	Standardization 0
2	Easy access to joints during assembly	Staging required at webs to tack 2 <sup>nd</sup> panel to 1 <sup>st</sup> built up panel.	
	Criteria assessment	Simplification 0	Standardization 0
3	Self supporting interim products	Yes	
	Criteria assessment	Simplification 0	Standardization 1
4	Minimize turning during assembly	One turn of 2 <sup>nd</sup> plate blanket onto 1 <sup>st</sup> built up panel. One turn of full block to weld 2 <sup>nd</sup> plate blanket.	
	Criteria assessment	Simplification 0	Standardization 0
5	Simplify connections. Minimize variety.	Fitted slots for longitudinals on first 1st panel. Cut outs with lugs both sides on 2 <sup>nd</sup> panel.	
	Criteria assessment	Simplification 1	Standardization 1
6	Maximize downhand fitting	Overhead fitting of 2 <sup>nd</sup> plate blanket and longitudinal lugs to 1 <sup>st</sup> built up panel.	
	Criteria assessment	Simplification 0	Standardization 0
7	Minimize joint length. Reduce no. of parts.	For a typical longitudinal bulb flat HP 340*14 on the parallel mid-body. Single lug: 950mm weld length; Fitted slot: 500 mm weld length.	
	Criteria assessment	Simplification 0	Standardization 0
8	Self aligning interim products. Reduce need for high accuracy levels.	Very high level of accuracy required to fully weld longitudinals and slide webs. No self alignment with open cut outs on 2nd panel.	
	Criteria assessment	Simplification 0	Standardization 0
9	Maximize the use of automated assembly lines	Uses automatic twin fillet welding of longitudinals on 1st and 2nd panels.	
	Criteria assessment	Simplification 0	Standardization 0
10	Maximize current facilities. Applicable to current technology level.	Requires significant accuracy control development. Requires specialized web pulling equipment.	
	Criteria assessment	Simplification 1	Standardization 1
11	Classification approval.	Requires design and approval of longitudinal slots.	
	Criteria assessment	Simplification 0	Standardization 0
<b>Total</b>		<b>1</b>	<b>2</b>

**Tab. 3.12. Assembly option evaluation for block assembly method 2-e [2], [30]**

No.	Engineering Criteria	Method 2-e	
1	Maximize downhand and automatic welding	No overhead welding.	
	Criteria assessment	Simplification 1	Standardization 1
2	Easy access to joints during assembly	Staging required to access upper longitudinals during slotting through webs.	
	Criteria assessment	Simplification 0	Standardization 0
3	Self supporting interim products	No	
	Criteria assessment	Simplification 0	Standardization 0
4	Minimize turning during assembly	One assembly turn of 1st built up panel onto 2 <sup>nd</sup> plate blanket.	
	Criteria assessment	Simplification 1	Standardization 1
5	Simplify connections. Minimize variety.	Fitted slots for longitudinals on 1 <sup>st</sup> and 2 <sup>nd</sup> panels.	
	Criteria assessment	Simplification 1	Standardization 1
6	Maximize downhand fitting	Overhead fitting of longitudinals through slots in webs.	
	Criteria assessment	Simplification 0	Standardization 1
7	Minimize joint length. Reduce no. of parts.	For a typical longitudinal bulb flat HP 340*14 on the parallel mid-body. Upper and lower slots: 1000 mm weld length.	
	Criteria assessment	Simplification 1	Standardization 1
8	Self aligning interim products. Reduce need for high accuracy levels.	Very high level of accuracy required to fully weld longitudinals and slide webs. High level of accuracy in webs for 2 <sup>nd</sup> panel longitudinals.	
	Criteria assessment	Simplification 0	Standardization 0
9	Maximize the use of automated assembly lines	Uses automatic twin fillet welding of longitudinals on 1st panel only.	
	Criteria assessment	Simplification 0	Standardization 0
10	Maximize current facilities. Applicable to current technology level.	Requires significant accuracy control development. Requires specialized web pulling equipment and upper longitudinal slotting equipment.	
	Criteria assessment	Simplification 0	Standardization 0
11	Classification approval.	Requires design and approval of longitudinal slots.	
	Criteria assessment	Simplification 0	Standardization 0
<b>Total</b>		<b>4</b>	<b>5</b>

**Tab. 3.13. Assembly option evaluation for block assembly method 2-f [2], [30]**

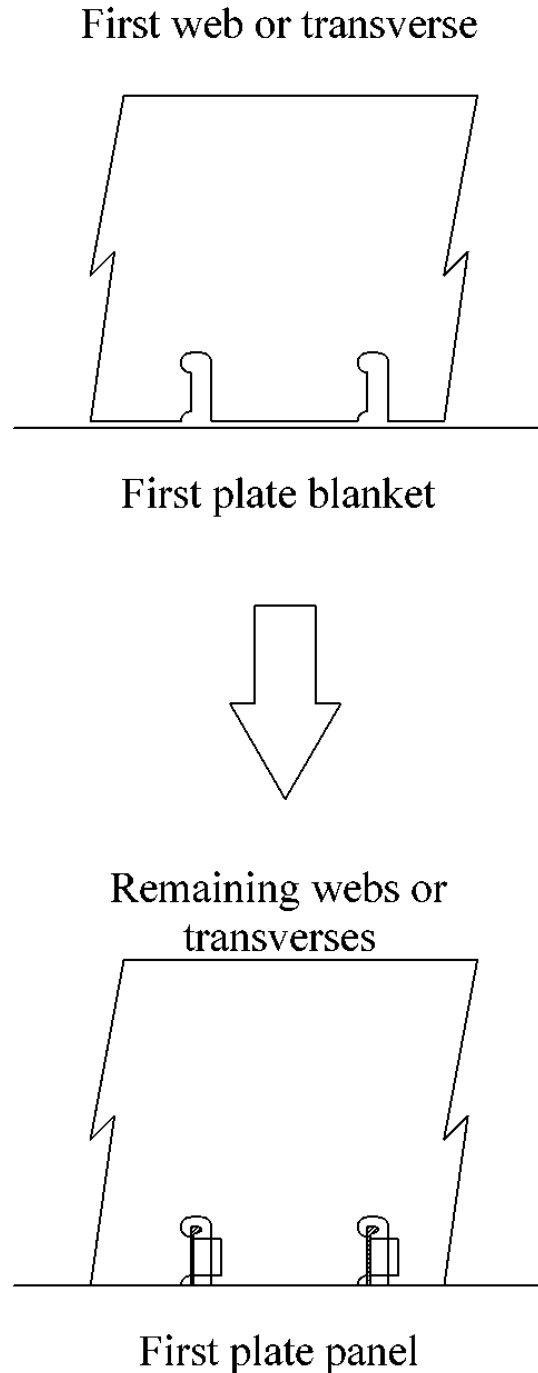
No.	Engineering Criteria	Method 2-f	
1	Maximize downhand and automatic welding	Overhead welding of longitudinals into web slots.	
	Criteria assessment	Simplification 0	Standardization 0
2	Easy access to joints during assembly	Staging required to weld upper longitudinals into slots in the webs.	
	Criteria assessment	Simplification 0	Standardization 0
3	Self supporting interim products	No	
	Criteria assessment	Simplification 0	Standardization 0
4	Minimize turning during assembly	One assembly turn of 1st built up panel onto 2 <sup>nd</sup> plate blanket.	
	Criteria assessment	Simplification 1	Standardization 1
5	Simplify connections. Minimize variety.	Fitted slots for longitudinals on 1 <sup>st</sup> and 2 <sup>nd</sup> panels.	
	Criteria assessment	Simplification 1	Standardization 1
6	Maximize downhand fitting	Overhead fitting of longitudinals through slots in webs.	
	Criteria assessment	Simplification 0	Standardization 1
7	Minimize joint length. Reduce no. of parts.	For a typical longitudinal bulb flat HP 340*14 on the parallel mid-body. Upper and lower slots: 1000 mm weld length.	
	Criteria assessment	Simplification 1	Standardization 1
8	Self aligning interim products. Reduce need for high accuracy levels.	Very high level of accuracy required to fully weld longitudinals and slide webs. High level of accuracy in webs for 2 <sup>nd</sup> panel longitudinals.	
	Criteria assessment	Simplification 0	Standardization 0
9	Maximize the use of automated assembly lines	Uses automatic twin fillet welding of longitudinals on 1st panel only.	
	Criteria assessment	Simplification 0	Standardization 0
10	Maximize current facilities. Applicable to current technology level.	Requires significant accuracy control development. Requires specialized web pulling equipment and upper longitudinal slotting equipment.	
	Criteria assessment	Simplification 0	Standardization 0
11	Classification approval.	Requires design and approval of longitudinal slots.	
	Criteria assessment	Simplification 0	Standardization 0
<b>Total</b>		<b>3</b>	<b>4</b>

**Tab. 3.14. Assembly option evaluation for block assembly method 2-g [2], [30]**

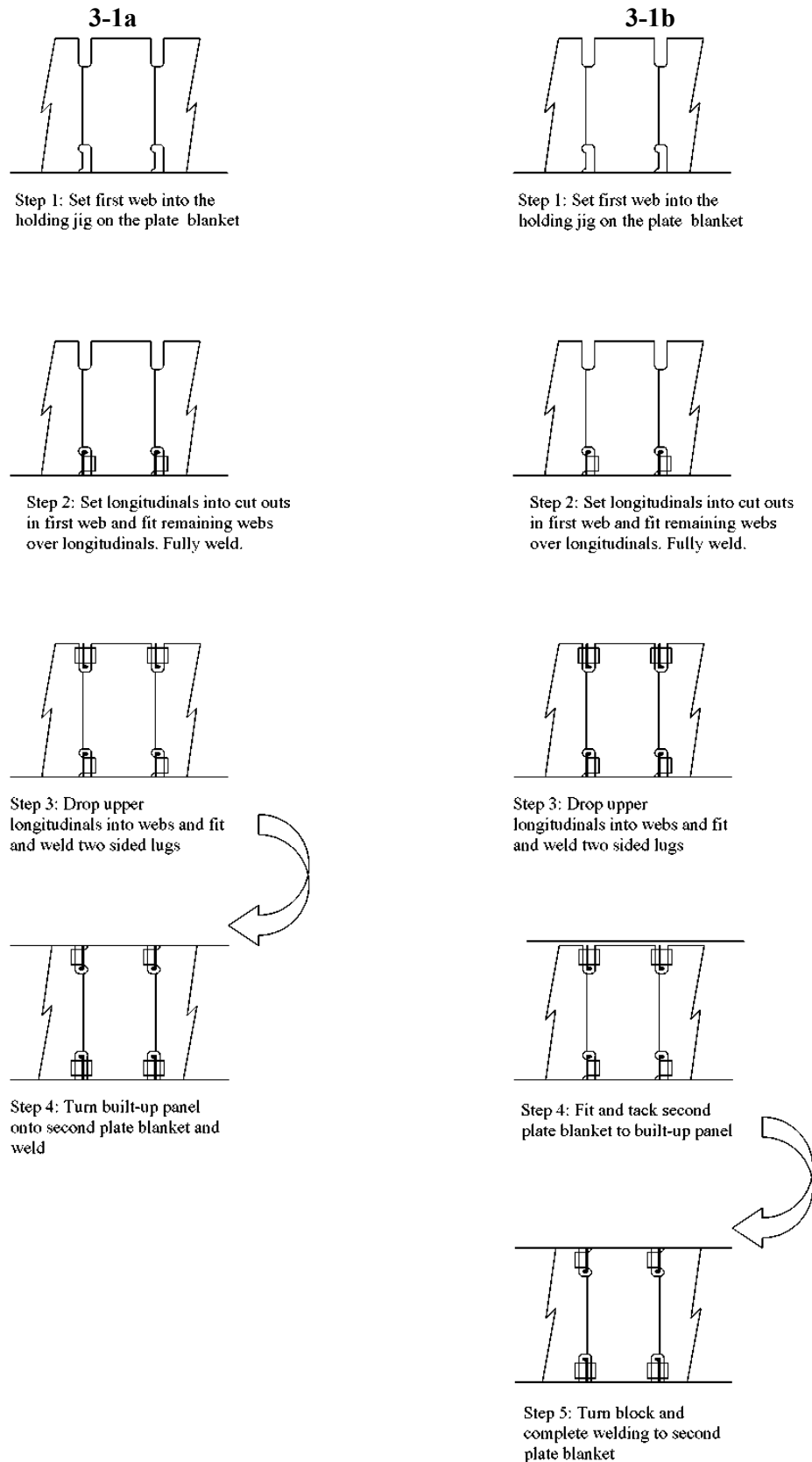
No.	Engineering Criteria	Method 2-g	
1	Maximize downhand and automatic welding	Overhead welding of longitudinals into web slots. Overhead tacking of 2 <sup>nd</sup> plate blanket to 1 <sup>st</sup> built up panel.	
	Criteria assessment	Simplification 0	Standardization 0
2	Easy access to joints during assembly	Staging required to weld upper longitudinals into slots in the webs. Staging required to tack 2 <sup>nd</sup> plate blanket to first built up panel.	
	Criteria assessment	Simplification 0	Standardization 0
3	Self supporting interim products	No	
	Criteria assessment	Simplification 0	Standardization 0
4	Minimize turning during assembly	One assembly turn of 2 <sup>nd</sup> plate blanket onto 1 <sup>st</sup> built up panel. One turn of full block to weld 2 <sup>nd</sup> plate blanket.	
	Criteria assessment	Simplification 0	Standardization 0
5	Simplify connections. Minimize variety.	Fitted slots for longitudinals on 1 <sup>st</sup> and 2 <sup>nd</sup> panels.	
	Criteria assessment	Simplification 1	Standardization 1
6	Maximize downhand fitting	Overhead fitting of longitudinals through slots in webs.	
	Criteria assessment	Simplification 0	Standardization 0
7	Minimize joint length. Reduce no. of parts.	For a typical longitudinal bulb flat HP 340*14 on the parallel mid-body. Upper and lower slots: 1000 mm weld length.	
	Criteria assessment	Simplification 1	Standardization 1
8	Self aligning interim products. Reduce need for high accuracy levels.	Very high level of accuracy required to fully weld longitudinals and slide webs. High level of accuracy in webs for 2 <sup>nd</sup> panel longitudinals.	
	Criteria assessment	Simplification 0	Standardization 0
9	Maximize the use of automated assembly lines	Uses automatic twin fillet welding of longitudinals on 1 <sup>st</sup> panel only.	
	Criteria assessment	Simplification 0	Standardization 0
10	Maximize current facilities. Applicable to current technology level.	Requires significant accuracy control development. Requires specialized web pulling equipment and upper longitudinal slotting equipment.	
	Criteria assessment	Simplification 0	Standardization 0
11	Classification approval.	Requires design and approval of longitudinal slots.	
	Criteria assessment	Simplification 0	Standardization 0
<b>Total</b>		<b>2</b>	<b>3</b>

**Assembly options for principal block assembly method 3-1**

Figure 3.20 shows the principal block assembly method 2 adapted for bulb plate longitudinals, while figures 3.21 to 3.24 illustrate the seven block assembly options. The complementary option evaluation tables 3.15 to 3.21 are included as well.



**Fig. 3.20. Principal block assembly method 3-1 [2], [30]**



**Fig. 3.21. Block assembly methods 3-1a and 3-1b [2], [30]**

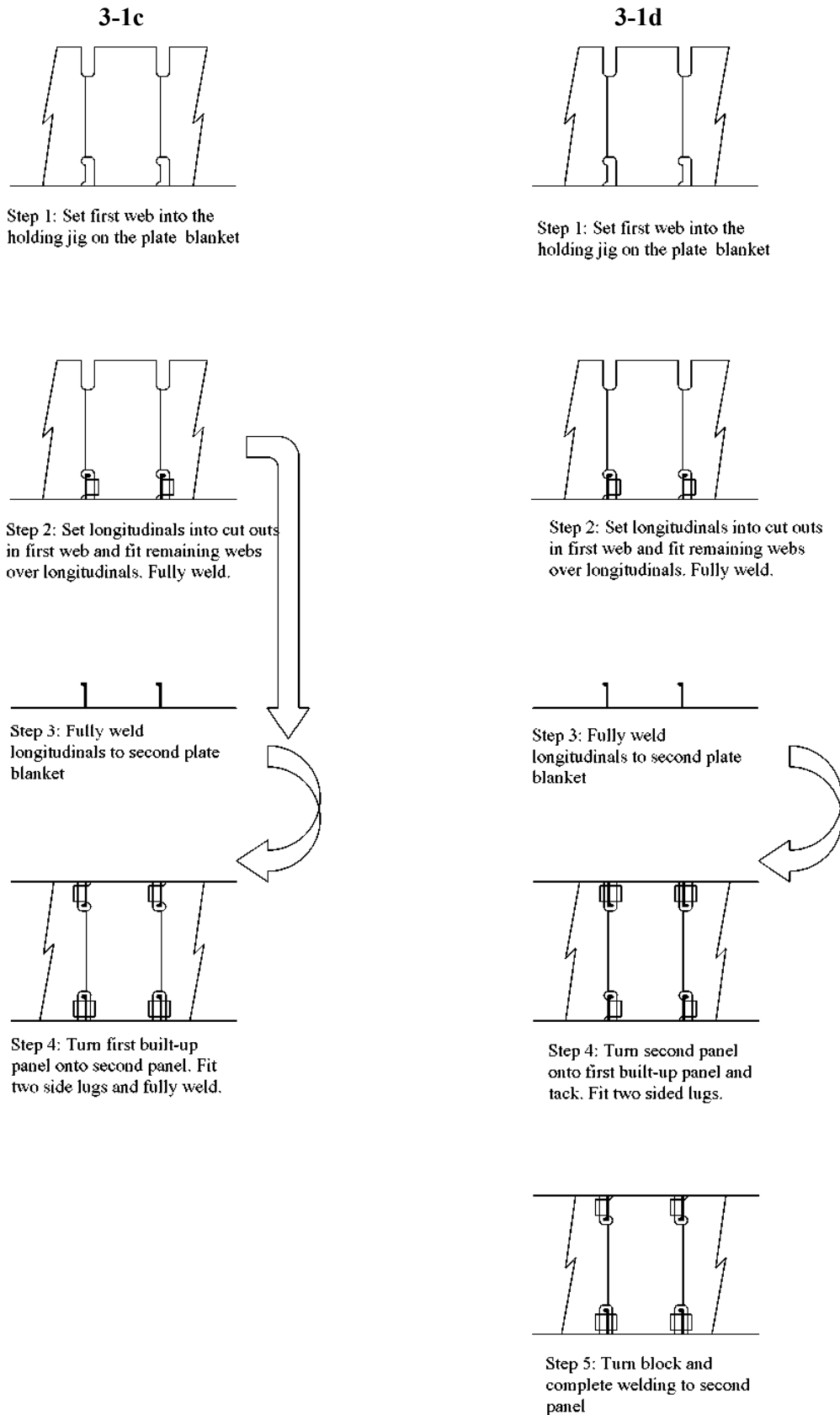
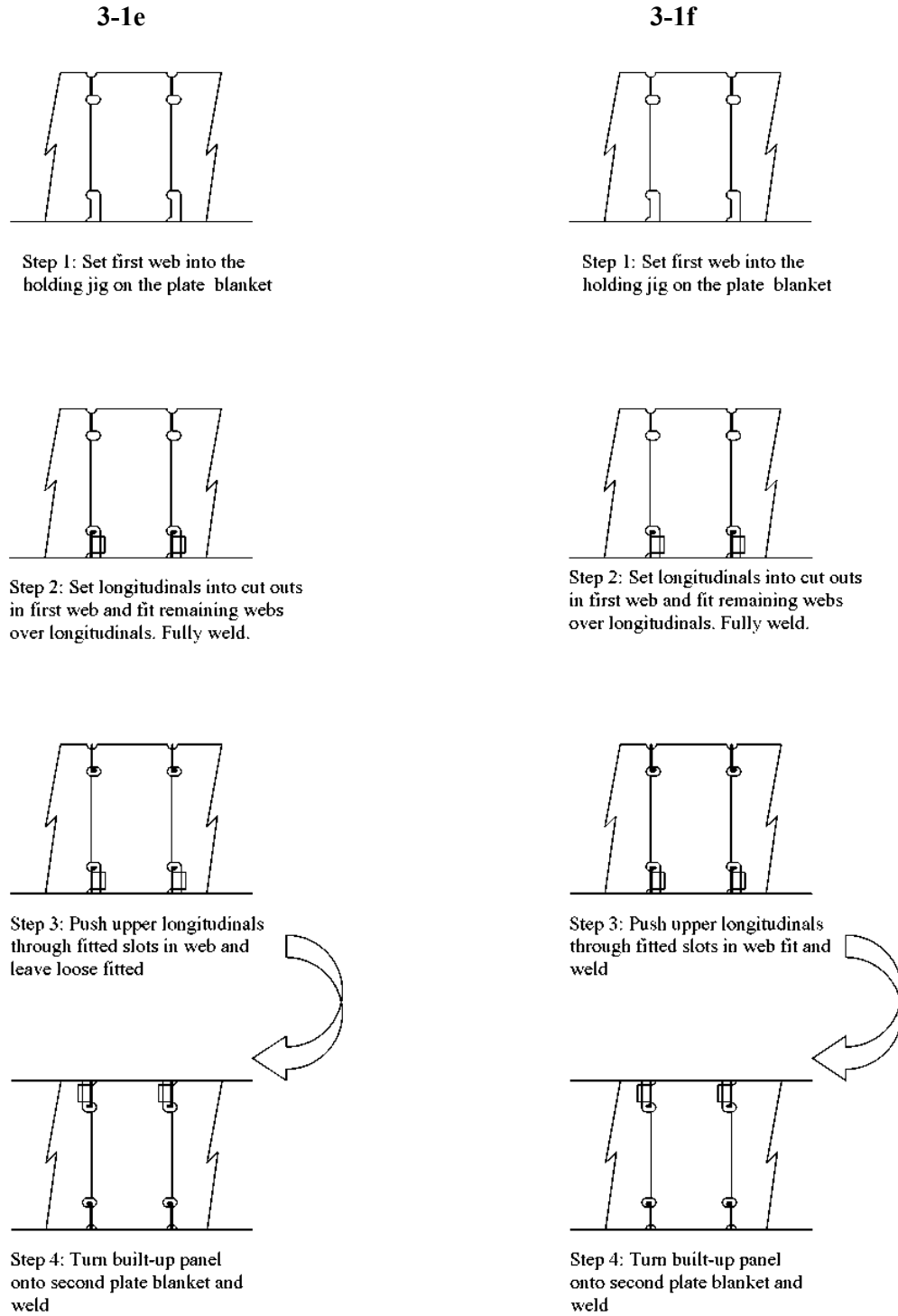
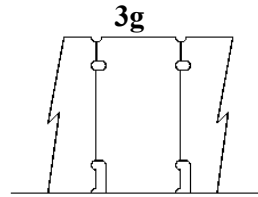


Fig. 3.22. Block assembly methods 3-1c and 3-1d [2], [30]

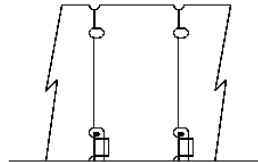


**Fig. 3.23. Block assembly methods 3-1e and 3-1f [2], [30]**

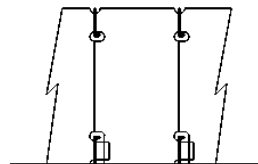




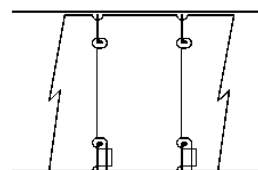
Step 1: Set first web into the holding jig on the plate blanket



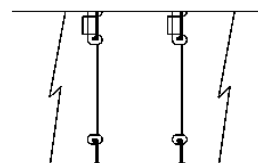
Step 2: Set longitudinals into cut outs in first web and fit remaining webs over longitudinals. Fully weld.



Step 3: Push upper longitudinals through fitted slots in web fit and weld



Step 4: Fit and tack second plate blanket to built-up panel



Step 5: Turn block and complete welding to second plate blanket

**Fig. 3.24. Block assembly method 3-1g [2], [30]**

**Tab. 3.15. Assembly option evaluation for block assembly method 3-1a [2], [30]**

No.	Engineering Criteria	Method 3-1a	
1	Maximize downhand and automatic welding	Overhead welding of longitudinals and lugs to webs.	
	Criteria assessment	Simplification 0	Standardization 0
2	Easy access to joints during assembly	Staging required at each web to fit longitudinals and lugs.	
	Criteria assessment	Simplification 0	Standardization 0
3	Self supporting interim products	No	
	Criteria assessment	Simplification 0	Standardization 0
4	Minimize turning during assembly	One assembly turn of 1st panel onto 2 <sup>nd</sup> plate blanket.	
	Criteria assessment	Simplification 1	Standardization 1
5	Simplify connections. Minimize variety.	Cut outs with lugs top and bottom.	
	Criteria assessment	Simplification 1	Standardization 1
6	Maximize downhand fitting	Overhead fitting of 2 <sup>nd</sup> panel longitudinals and lugs into web cut outs.	
	Criteria assessment	Simplification 0	Standardization 0
7	Minimize joint length. Reduce no. of parts.	For a typical longitudinal bulb flat HP 340*14 on the parallel mid-body. One-sided lug: 950mm weld length; Double sided lug: 1400 mm weld length.	
	Criteria assessment	Simplification 0	Standardization 1
8	Self aligning interim products. Reduce need for high accuracy levels.	Web alignment at single lug cut out. Minimum accuracy needed for fitting webs to first panel.	
	Criteria assessment	Simplification 0	Standardization 1
9	Maximize the use of automated assembly lines	Does not use automatic twin fillet welding of longitudinals on panels.	
	Criteria assessment	Simplification 0	Standardization 0
10	Maximize current facilities. Applicable to current technology level.	Requires no technology development. Does not utilize automatic twin fillet welding.	
	Criteria assessment	Simplification 0	Standardization 0
11	Classification approval.	Within current technology level, all details approved.	
	Criteria assessment	Simplification 1	Standardization 1
<b>Total</b>		<b>3</b>	<b>5</b>

**Tab. 3.16. Assembly option evaluation for block assembly method 3-1b [2], [30]**

No.	Engineering Criteria	Method 3-1b	
1	Maximize downhand and automatic welding	Overhead welding of upper longitudinals and lugs to webs. Overhead tacking of plate blanket to built up panel.	
	Criteria assessment	Simplification 0	Standardization 0
2	Easy access to joints during assembly	Staging required at each web to fit longitudinals and lugs. Staging required to tack plate blanket to built up panel.	
	Criteria assessment	Simplification 0	Standardization 0
3	Self supporting interim products	No	
	Criteria assessment	Simplification 0	Standardization 0
4	Minimize turning during assembly	One turn of 2 <sup>nd</sup> plate blanket onto 1 <sup>st</sup> built up panel. One turn of full block to weld 2 <sup>nd</sup> plate blanket.	
	Criteria assessment	Simplification 0	Standardization 0
5	Simplify connections. Minimize variety.	Cut outs with lugs top and bottom.	
	Criteria assessment	Simplification 1	Standardization 1
6	Maximize downhand fitting	Overhead fitting of 2 <sup>nd</sup> panel longitudinals and lugs into web cut outs. Overhead fitting of 2 <sup>nd</sup> plate blanket to 1 <sup>st</sup> built up panel.	
	Criteria assessment	Simplification 0	Standardization 0
7	Minimize joint length. Reduce no. of parts.	For a typical longitudinal bulb flat HP 340*14 on the parallel mid-body. One-sided lug: 950mm weld length; Double sided lug: 1400 mm weld length.	
	Criteria assessment	Simplification 0	Standardization 1
8	Self aligning interim products. Reduce need for high accuracy levels.	Web alignment at single lug cut out. Minimum accuracy needed for fitting webs to first panel.	
	Criteria assessment	Simplification 0	Standardization 1
9	Maximize the use of automated assembly lines	Does not use automatic twin fillet welding of longitudinals on panels.	
	Criteria assessment	Simplification 0	Standardization 0
10	Maximize current facilities. Applicable to current technology level.	Requires no technology development. Does not utilize automatic twin fillet welding.	
	Criteria assessment	Simplification 0	Standardization 0
11	Classification approval.	Within current technology level, all details approved.	
	Criteria assessment	Simplification 1	Standardization 1
<b>Total</b>		<b>2</b>	<b>4</b>

**Tab. 3.17. Assembly option evaluation for block assembly method 3-1c [2], [30]**

No.	Engineering Criteria	Method 3-1c	
1	Maximize downhand and automatic welding	No overhead welding.	
	Criteria assessment	Simplification 1	Standardization 1
2	Easy access to joints during assembly	Simplified access to assembly joints.	
	Criteria assessment	Simplification 1	Standardization 1
3	Self supporting interim products	Yes	
	Criteria assessment	Simplification 1	Standardization 1
4	Minimize turning during assembly	One assembly turn of built up 1 <sup>st</sup> panel onto 2 <sup>nd</sup> plate panel.	
	Criteria assessment	Simplification 1	Standardization 1
5	Simplify connections. Minimize variety.	Cut outs with lugs top and bottom.	
	Criteria assessment	Simplification 1	Standardization 1
6	Maximize downhand fitting	All downhand fitting.	
	Criteria assessment	Simplification 1	Standardization 1
7	Minimize joint length. Reduce no. of parts.	For a typical longitudinal bulb flat HP 340*14 on the parallel mid-body. One-sided lug: 950mm weld length; Double sided lug: 1400 mm weld length.	
	Criteria assessment	Simplification 0	Standardization 1
8	Self aligning interim products. Reduce need for high accuracy levels.	Web alignment at single lug cut out. Minimum accuracy needed for fitting webs to first panel and longitudinals to 2 <sup>nd</sup> panel.	
	Criteria assessment	Simplification 1	Standardization 1
9	Maximize the use of automated assembly lines	Uses automatic twin fillet welding of longitudinals on 2 <sup>nd</sup> panel only.	
	Criteria assessment	Simplification 0	Standardization 0
10	Maximize current facilities. Applicable to current technology level.	Requires no technology development. Utilizes automatic twin fillet welding on 2 <sup>nd</sup> panel only.	
	Criteria assessment	Simplification 0	Standardization 0
11	Classification approval.	Within current technology level, all details approved.	
	Criteria assessment	Simplification 1	Standardization 1
<b>Total</b>		<b>8</b>	<b>9</b>

**Tab. 3.18. Assembly option evaluation for block assembly method 3-1d [2], [30]**

No.	Engineering Criteria	Method 3-1d	
1	Maximize downhand and automatic welding	Overhead tacking of 2 <sup>nd</sup> plate panel to 1 <sup>st</sup> built up panel.	
	Criteria assessment	Simplification 0	Standardization 0
2	Easy access to joints during assembly	Staging required at webs to tack 2 <sup>nd</sup> panel to 1 <sup>st</sup> built up panel.	
	Criteria assessment	Simplification 0	Standardization 0
3	Self supporting interim products	Yes	
	Criteria assessment	Simplification 0	Standardization 1
4	Minimize turning during assembly	One turn of 2 <sup>nd</sup> plate panel onto 1 <sup>st</sup> built up panel. One turn of full block to weld 2 <sup>nd</sup> plate panel.	
	Criteria assessment	Simplification 0	Standardization 0
5	Simplify connections. Minimize variety.	Cut outs with lugs top and bottom.	
	Criteria assessment	Simplification 1	Standardization 1
6	Maximize downhand fitting	Overhead fitting of 2 <sup>nd</sup> plate blanket and longitudinal lugs to 1 <sup>st</sup> built up panel.	
	Criteria assessment	Simplification 0	Standardization 0
7	Minimize joint length. Reduce no. of parts.	For a typical longitudinal bulb flat HP 340*14 on the parallel mid-body. One-sided lug: 950mm weld length; Double sided lug: 1400 mm weld length.	
	Criteria assessment	Simplification 0	Standardization 1
8	Self aligning interim products. Reduce need for high accuracy levels.	Web alignment at single lug cut out. Minimum accuracy needed for fitting webs to first panel and longitudinals to 2 <sup>nd</sup> panel.	
	Criteria assessment	Simplification 0	Standardization 0
9	Maximize the use of automated assembly lines	Uses automatic twin fillet welding of longitudinals on 2 <sup>nd</sup> panel only.	
	Criteria assessment	Simplification 0	Standardization 0
10	Maximize current facilities. Applicable to current technology level.	Requires no technology development. Utilizes automatic twin fillet welding on 2 <sup>nd</sup> panel only.	
	Criteria assessment	Simplification 0	Standardization 0
11	Classification approval.	Within current technology level, all details approved.	
	Criteria assessment	Simplification 1	Standardization 1
<b>Total</b>		<b>2</b>	<b>4</b>

**Tab. 3.19. Assembly option evaluation for block assembly method 3-1e [2], [30]**

No.	Engineering Criteria	Method 3-1e	
1	Maximize downhand and automatic welding	No overhead welding.	
	Criteria assessment	Simplification 1	Standardization 1
2	Easy access to joints during assembly	Staging required to access upper longitudinals during slotting through webs.	
	Criteria assessment	Simplification 0	Standardization 0
3	Self supporting interim products	No	
	Criteria assessment	Simplification 0	Standardization 0
4	Minimize turning during assembly	One assembly turn of 1 <sup>st</sup> built up panel onto 2 <sup>nd</sup> plate blanket.	
	Criteria assessment	Simplification 1	Standardization 1
5	Simplify connections. Minimize variety.	Cut outs with lugs at the top. Fitted slots at the bottom.	
	Criteria assessment	Simplification 0	Standardization 0
6	Maximize downhand fitting	All downhand fitting.	
	Criteria assessment	Simplification 1	Standardization 1
7	Minimize joint length. Reduce no. of parts.	For a typical longitudinal bulb flat HP 340*14 on the parallel mid-body. One-sided lug: 950mm weld length; Slot: 500 mm weld length.	
	Criteria assessment	Simplification 1	Standardization 0
8	Self aligning interim products. Reduce need for high accuracy levels.	Web alignment at single lug cut out. Minimum accuracy needed for fitting webs to first panel. High accuracy for slots.	
	Criteria assessment	Simplification 0	Standardization 0
9	Maximize the use of automated assembly lines	Does not use automatic twin fillet welding of longitudinals on panels.	
	Criteria assessment	Simplification 0	Standardization 0
10	Maximize current facilities. Applicable to current technology level.	Requires significant accuracy control development. Requires upper longitudinal slotting equipment.	
	Criteria assessment	Simplification 0	Standardization 0
11	Classification approval.	Requires design and approval of longitudinal slots.	
	Criteria assessment	Simplification 0	Standardization 0
<b>Total</b>		<b>4</b>	<b>3</b>

**Tab. 3.20. Assembly option evaluation for block assembly method 3-1f [2], [30]**

No.	Engineering Criteria	Method 3-1f	
1	Maximize downhand and automatic welding	Overhead welding of longitudinals into web slots.	
	Criteria assessment	Simplification 0	Standardization 0
2	Easy access to joints during assembly	Staging required to weld upper longitudinals into slots in the webs.	
	Criteria assessment	Simplification 0	Standardization 0
3	Self supporting interim products	No	
	Criteria assessment	Simplification 0	Standardization 0
4	Minimize turning during assembly	One assembly turn of 1 <sup>st</sup> built up panel onto 2 <sup>nd</sup> plate blanket.	
	Criteria assessment	Simplification 1	Standardization 1
5	Simplify connections. Minimize variety.	Cut outs with lugs at the top. Fitted slots at the bottom.	
	Criteria assessment	Simplification 0	Standardization 0
6	Maximize downhand fitting	Overhead fitting of longitudinals in slots in webs.	
	Criteria assessment	Simplification 0	Standardization 0
7	Minimize joint length. Reduce no. of parts.	For a typical longitudinal bulb flat HP 340*14 on the parallel mid-body. One-sided lug: 950mm weld length; Slot: 500 mm weld length.	
	Criteria assessment	Simplification 1	Standardization 0
8	Self aligning interim products. Reduce need for high accuracy levels.	Web alignment at single lug cut out. Minimum accuracy needed for fitting webs to first panel. High accuracy for slots.	
	Criteria assessment	Simplification 0	Standardization 0
9	Maximize the use of automated assembly lines	Does not use automatic twin fillet welding of longitudinals on panels.	
	Criteria assessment	Simplification 0	Standardization 0
10	Maximize current facilities. Applicable to current technology level.	Requires significant accuracy control development. Requires upper longitudinal slotting equipment.	
	Criteria assessment	Simplification 0	Standardization 0
11	Classification approval.	Requires design and approval of longitudinal slots.	
	Criteria assessment	Simplification 0	Standardization 0
<b>Total</b>		<b>2</b>	<b>1</b>

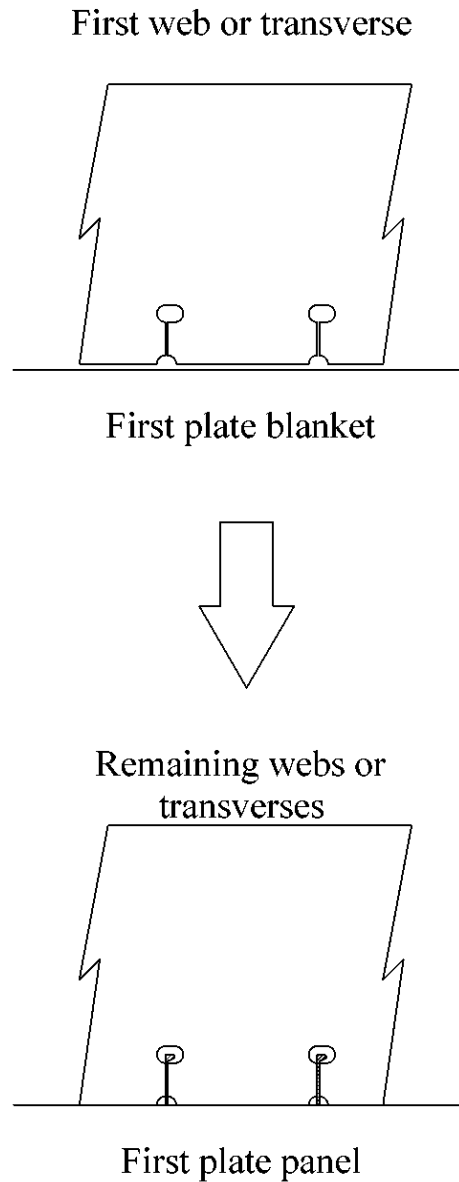
**Tab. 3.21. Assembly option evaluation for block assembly method 3-1g [2], [30]**

No.	Engineering Criteria	Method 3-1g	
1	Maximize downhand and automatic welding	Overhead welding of longitudinals into web slots. Overhead tacking of 2 <sup>nd</sup> plate blanket to 1 <sup>st</sup> built up panel.	
	Criteria assessment	Simplification 0	Standardization 0
2	Easy access to joints during assembly	Staging required to weld upper longitudinals into slots in the webs. Staging required to tack 2 <sup>nd</sup> plate blanket to first built up panel.	
	Criteria assessment	Simplification 0	Standardization 0
3	Self supporting interim products	No	
	Criteria assessment	Simplification 0	Standardization 0
4	Minimize turning during assembly	One turn of 2 <sup>nd</sup> plate blanket onto 1 <sup>st</sup> built up panel. One turn of full block to weld 2 <sup>nd</sup> plate blanket.	
	Criteria assessment	Simplification 0	Standardization 0
5	Simplify connections. Minimize variety.	Cut outs with lugs at the top. Fitted slots at the bottom.	
	Criteria assessment	Simplification 0	Standardization 0
6	Maximize downhand fitting	Overhead fitting of longitudinals in slots in webs. Overhead fitting of 2 <sup>nd</sup> plate blanket to 1 <sup>st</sup> built up panel.	
	Criteria assessment	Simplification 0	Standardization 0
7	Minimize joint length. Reduce no. of parts.	For a typical longitudinal bulb flat HP 340*14 on the parallel mid-body. One-sided lug: 950mm weld length; Slot: 500 mm weld length.	
	Criteria assessment	Simplification 1	Standardization 0
8	Self aligning interim products. Reduce need for high accuracy levels.	Web alignment at single lug cut out. Minimum accuracy needed for fitting webs to first panel. High accuracy for slots.	
	Criteria assessment	Simplification 0	Standardization 0
9	Maximize the use of automated assembly lines	Does not use automatic twin fillet welding of longitudinals on panels.	
	Criteria assessment	Simplification 0	Standardization 0
10	Maximize current facilities. Applicable to current technology level.	Requires significant accuracy control development. Requires upper longitudinal slotting equipment.	
	Criteria assessment	Simplification 0	Standardization 0
11	Classification approval.	Requires design and approval of longitudinal slots.	
	Criteria assessment	Simplification 0	Standardization 0
<b>Total</b>		<b>1</b>	<b>0</b>



**Assembly options for principal block assembly method 3-2**

Figure 3.25 shows the principal block assembly method 3-2 adapted for bulb plate longitudinals, while figures 3.26 to 3.29 illustrate the seven options. The complementary option evaluation tables 3.22 to 3.28 are included as well.



**Fig. 3.25. Principal block assembly method 3-2 [2], [30]**

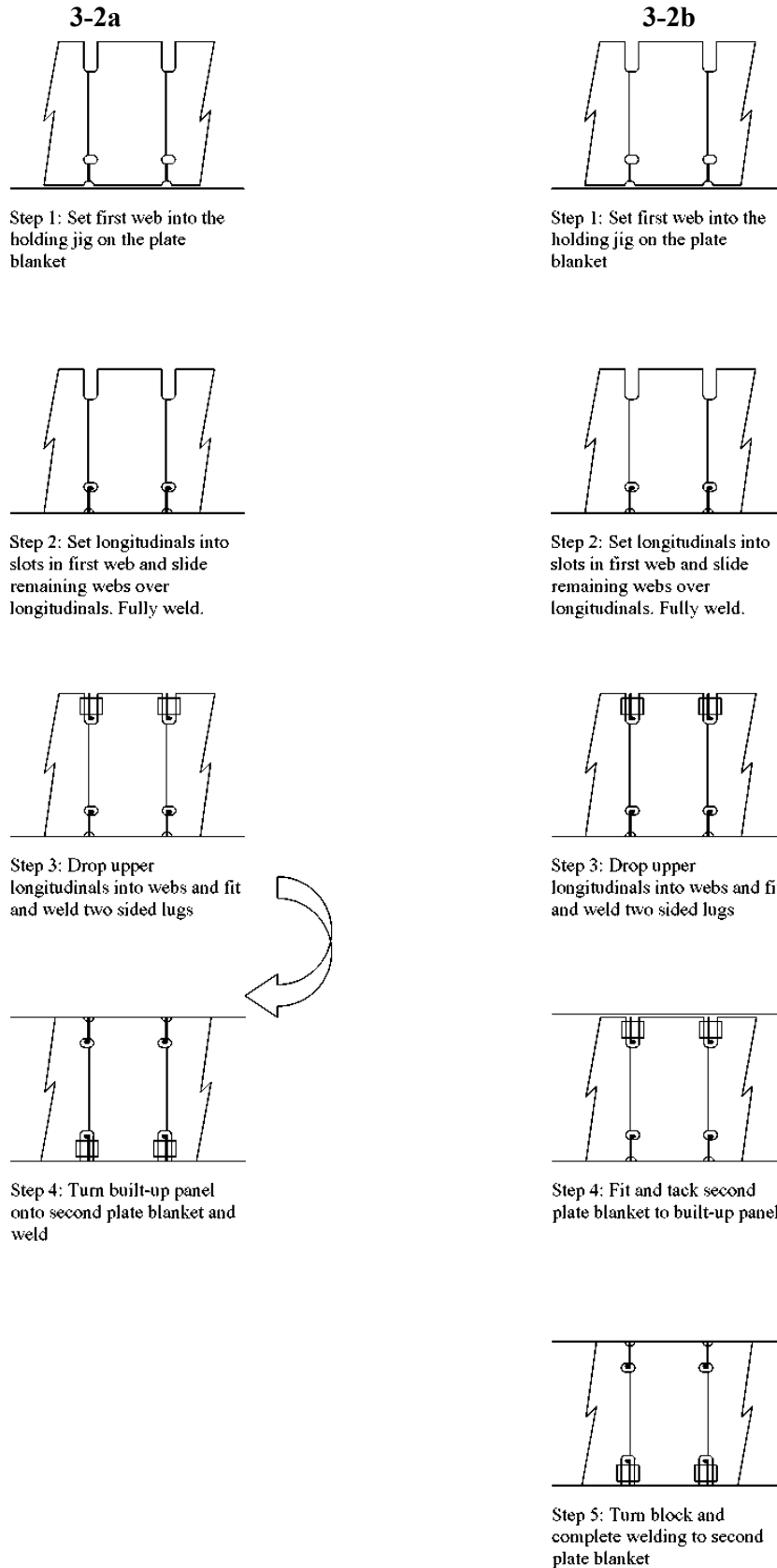
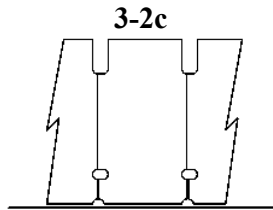
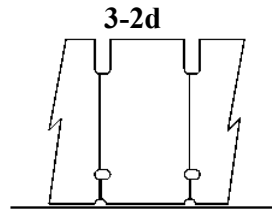


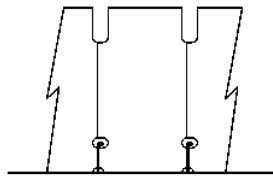
Fig. 3.26. Block assembly methods 3-2a and 3-2b [2], [30]



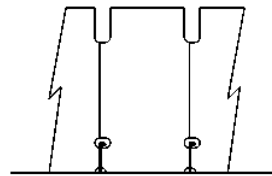
Step 1: Set first web into the holding jig on the plate blanket



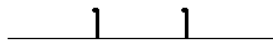
Step 1: Set first web into the holding jig on the plate blanket



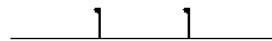
Step 2: Set longitudinals into slots in first web and slide remaining webs over longitudinals. Fully weld.



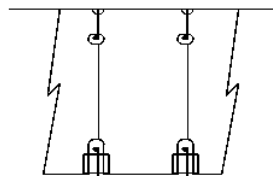
Step 2: Set longitudinals into slots in first web and slide remaining webs over longitudinals. Fully weld.



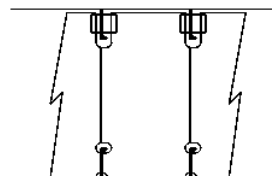
Step 3: Fully weld longitudinals to second plate blanket



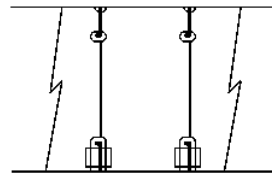
Step 3: Fully weld longitudinals to second plate blanket



Step 4: Turn first built-up panel onto second panel. Fit two sided lugs and fully weld.

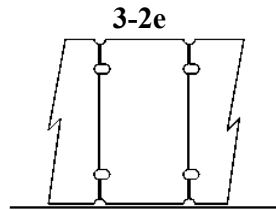


Step 4: Turn second panel onto first built-up panel and tack. Fit two sided lugs.

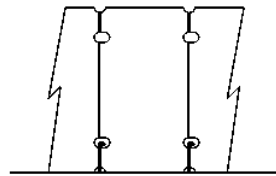


Step 5: Turn block and complete welding to second panel

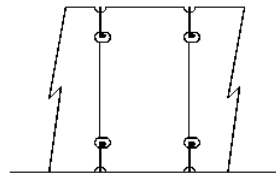
Fig. 3.27. Block assembly methods 3-2c and 3-2d [2], [30]



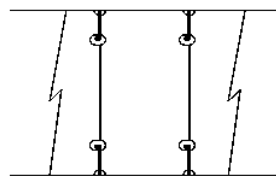
Step 1: Set first web into the holding jig on the plate blanket



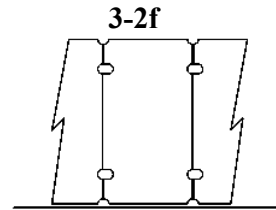
Step 2: Set longitudinals into slots in first web and slide remaining webs over longitudinals. Fully weld.



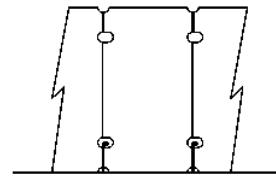
Step 3: Push upper longitudinals through fitted slots in web and leave loose fitted



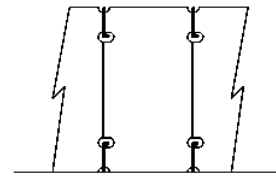
Step 4: Turn built-up panel onto second plate blanket and weld



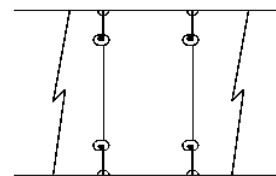
Step 1: Set first web into the holding jig on the plate blanket



Step 2: Set longitudinals into slots in first web and slide remaining webs over longitudinals. Fully weld.

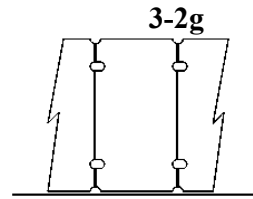


Step 3: Push upper longitudinals through fitted slots in web fit and weld

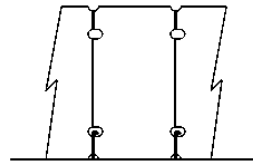


Step 4: Turn built-up panel onto second plate blanket and weld

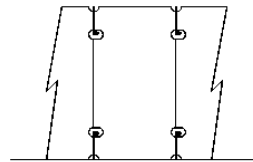
Fig. 3.28. Block assembly methods 3-2e and 3-2f [2], [30]



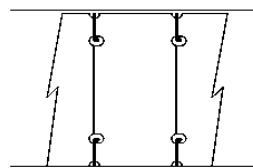
Step 1: Set first web into the holding jig on the plate blanket



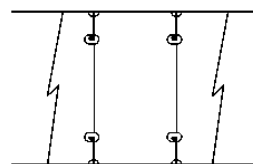
Step 2: Set longitudinals into slots in first web and slide remaining webs over longitudinals. Fully weld.



Step 3: Push upper longitudinals through fitted slots in web fit and weld



Step 4: Fit and tack second plate blanket to built-up panel



Step 5: Turn block and complete welding to second plate blanket

**Fig. 3.29. Block assembly method 3-2g [2], [30]**

**Tab. 3.22. Assembly option evaluation for block assembly method 3-2a [2], [30]**

No.	Engineering Criteria	Method 3-2a	
1	Maximize downhand and automatic welding	Overhead welding of longitudinals and lugs to webs.	
	Criteria assessment	Simplification 0	Standardization 0
2	Easy access to joints during assembly	Staging required at each web to fit longitudinals and lugs.	
	Criteria assessment	Simplification 0	Standardization 0
3	Self supporting interim products	No	
	Criteria assessment	Simplification 0	Standardization 0
4	Minimize turning during assembly	One assembly turn of built-up 1 <sup>st</sup> panel onto 2 <sup>nd</sup> plate blanket.	
	Criteria assessment	Simplification 1	Standardization 1
5	Simplify connections. Minimize variety.	Fitted slots for longitudinals on 1 <sup>st</sup> panel. Cut outs with lugs both sides on 2 <sup>nd</sup> panel.	
	Criteria assessment	Simplification 0	Standardization 0
6	Maximize downhand fitting	Overhead fitting of 2 <sup>nd</sup> panel longitudinals and lugs into web cut outs.	
	Criteria assessment	Simplification 0	Standardization 0
7	Minimize joint length. Reduce no. of parts.	For a typical longitudinal bulb flat HP 340*14 on the parallel mid-body. Double-sided lug: 1400mm weld length; Slot: 500 mm weld length.	
	Criteria assessment	Simplification 0	Standardization 0
8	Self aligning interim products. Reduce need for high accuracy levels.	High level of accuracy required to slide webs easily over longitudinals. No self alignment with open cut outs on 2 <sup>nd</sup> panel.	
	Criteria assessment	Simplification 0	Standardization 0
9	Maximize the use of automated assembly lines	Does not use automatic twin fillet welding of longitudinals on panels.	
	Criteria assessment	Simplification 0	Standardization 0
10	Maximize current facilities. Applicable to current technology level.	Requires significant accuracy control development. Requires special web pulling equipment.	
	Criteria assessment	Simplification 0	Standardization 0
11	Classification approval.	Requires design and approval of longitudinal slots.	
	Criteria assessment	Simplification 0	Standardization 0
<b>Total</b>		<b>1</b>	<b>1</b>

**Tab. 3.23. Assembly option evaluation for block assembly method 3-2b [2], [30]**

No.	Engineering Criteria	Method 3-2b	
1	Maximize downhand and automatic welding	Overhead welding of upper longitudinals to webs. Overhead welding of plate blanket to built up panel.	
	Criteria assessment	Simplification 0	Standardization 0
2	Easy access to joints during assembly	Staging required at each web to fit longitudinals and lugs. Staging required to tack plate blanket to built up panel.	
	Criteria assessment	Simplification 0	Standardization 0
3	Self supporting interim products	No	
	Criteria assessment	Simplification 0	Standardization 0
4	Minimize turning during assembly	One turn of 2nd plate blanket onto 1 <sup>st</sup> built up panel. One turn of full block to weld 2 <sup>nd</sup> plate blanket.	
	Criteria assessment	Simplification 0	Standardization 0
5	Simplify connections. Minimize variety.	Fitted slots for longitudinals on 1 <sup>st</sup> panel. Cut outs with lugs both sides on 2 <sup>nd</sup> panel.	
	Criteria assessment	Simplification 0	Standardization 0
6	Maximize downhand fitting	Overhead fitting of 2 <sup>nd</sup> plate blanket to 1 <sup>st</sup> built up panel.	
	Criteria assessment	Simplification 0	Standardization 0
7	Minimize joint length. Reduce no. of parts.	For a typical longitudinal bulb flat HP 340*14 on the parallel mid-body. Double-sided lug: 1400mm weld length; Slot: 500 mm weld length.	
	Criteria assessment	Simplification 0	Standardization 0
8	Self aligning interim products. Reduce need for high accuracy levels.	High level of accuracy required to slide webs easily over longitudinals. No self alignment with open cut outs on 2 <sup>nd</sup> panel.	
	Criteria assessment	Simplification 0	Standardization 0
9	Maximize the use of automated assembly lines	Does not use automatic twin fillet welding of longitudinals on panels.	
	Criteria assessment	Simplification 0	Standardization 0
10	Maximize current facilities. Applicable to current technology level.	Requires significant accuracy control development. Requires special web pulling equipment.	
	Criteria assessment	Simplification 0	Standardization 0
11	Classification approval.	Requires design and approval of longitudinal slots.	
	Criteria assessment	Simplification 0	Standardization 0
<b>Total</b>		<b>0</b>	<b>0</b>

**Tab. 3.24. Assembly option evaluation for block assembly method 3-2c [2], [30]**

No.	Engineering Criteria	Method 3-2c	
1	Maximize downhand and automatic welding	No overhead welding.	
	Criteria assessment	Simplification 1	Standardization 1
2	Easy access to joints during assembly	Simplified access to assembly joints.	
	Criteria assessment	Simplification 1	Standardization 1
3	Self supporting interim products	Yes	
	Criteria assessment	Simplification 1	Standardization 1
4	Minimize turning during assembly	One assembly turn of 1st built up panel onto 2 <sup>nd</sup> plate panel.	
	Criteria assessment	Simplification 1	Standardization 1
5	Simplify connections. Minimize variety.	Fitted slots for longitudinals on 1 <sup>st</sup> panel. Cut outs with lugs both sides on 2 <sup>nd</sup> panel.	
	Criteria assessment	Simplification 0	Standardization 0
6	Maximize downhand fitting	All downhand fitting.	
	Criteria assessment	Simplification 1	Standardization 1
7	Minimize joint length. Reduce no. of parts.	For a typical longitudinal bulb flat HP 340*14 on the parallel mid-body. Double-sided lug: 1400mm weld length; Slot: 500 mm weld length.	
	Criteria assessment	Simplification 0	Standardization 0
8	Self aligning interim products. Reduce need for high accuracy levels.	High level of accuracy required to slide webs easily over longitudinals. No self alignment with open cut outs on 2 <sup>nd</sup> panel.	
	Criteria assessment	Simplification 0	Standardization 0
9	Maximize the use of automated assembly lines	Uses automatic twin fillet welding of longitudinals on 2 <sup>nd</sup> panel only.	
	Criteria assessment	Simplification 0	Standardization 0
10	Maximize current facilities. Applicable to current technology level.	Requires significant accuracy control development. Requires specialized web pulling equipment.	
	Criteria assessment	Simplification 0	Standardization 0
11	Classification approval.	Requires design and approval of longitudinal slots.	
	Criteria assessment	Simplification 0	Standardization 0
<b>Total</b>		<b>5</b>	<b>5</b>



**Tab. 3.25. Assembly option evaluation for block assembly method 3-2d [2], [30]**

No.	Engineering Criteria	Method 3-2d	
1	Maximize downhand and automatic welding	Overhead tacking of 2 <sup>nd</sup> plate panel to 1 <sup>st</sup> built up panel.	
	Criteria assessment	Simplification 0	Standardization 0
2	Easy access to joints during assembly	Staging required at webs to tack 2 <sup>nd</sup> panel to 1 <sup>st</sup> built up unit.	
	Criteria assessment	Simplification 0	Standardization 0
3	Self supporting interim products	Yes	
	Criteria assessment	Simplification 1	Standardization 1
4	Minimize turning during assembly	One turn of 2 <sup>nd</sup> plate panel onto 1 <sup>st</sup> built up panel. One turn of full block to weld 2 <sup>nd</sup> plate panel.	
	Criteria assessment	Simplification 0	Standardization 0
5	Simplify connections. Minimize variety.	Fitted slots for longitudinals on 1 <sup>st</sup> panel. Cut outs with lugs both sides on 2 <sup>nd</sup> panel.	
	Criteria assessment	Simplification 0	Standardization 0
6	Maximize downhand fitting	Overhead fitting of 2 <sup>nd</sup> plate blanket and longitudinal lugs to 1 <sup>st</sup> built up panel.	
	Criteria assessment	Simplification 0	Standardization 0
7	Minimize joint length. Reduce no. of parts.	For a typical longitudinal bulb flat HP 340*14 on the parallel mid-body. Double-sided lug: 1400mm weld length; Slot: 500 mm weld length.	
	Criteria assessment	Simplification 0	Standardization 0
8	Self aligning interim products. Reduce need for high accuracy levels.	High level of accuracy required to slide webs easily over longitudinals. No self alignment with open cut outs on 2 <sup>nd</sup> panel.	
	Criteria assessment	Simplification 0	Standardization 0
9	Maximize the use of automated assembly lines	Uses automatic twin fillet welding of longitudinals on 2 <sup>nd</sup> panel only.	
	Criteria assessment	Simplification 0	Standardization 0
10	Maximize current facilities. Applicable to current technology level.	Requires significant accuracy control development. Requires specialized web pulling equipment.	
	Criteria assessment	Simplification 0	Standardization 0
11	Classification approval.	Requires design and approval of longitudinal slots.	
	Criteria assessment	Simplification 0	Standardization 0
<b>Total</b>		<b>0</b>	<b>1</b>

**Tab. 3.26. Assembly option evaluation for block assembly method 3-2e [2], [30]**

No.	Engineering Criteria	Method 3-2e	
1	Maximize downhand and automatic welding	No overhead welding.	
	Criteria assessment	Simplification 1	Standardization 1
2	Easy access to joints during assembly	Staging required to access upper longitudinals during sliding through webs.	
	Criteria assessment	Simplification 0	Standardization 0
3	Self supporting interim products	No	
	Criteria assessment	Simplification 1	Standardization 1
4	Minimize turning during assembly	One assembly turn of 1 <sup>st</sup> built up panel onto 2 <sup>nd</sup> plate blanket.	
	Criteria assessment	Simplification 1	Standardization 1
5	Simplify connections. Minimize variety.	Fitted slots for longitudinals on 1 <sup>st</sup> and 2 <sup>nd</sup> panels.	
	Criteria assessment	Simplification 1	Standardization 1
6	Maximize downhand fitting	Overhead fitting of longitudinals through slots in webs.	
	Criteria assessment	Simplification 0	Standardization 1
7	Minimize joint length. Reduce no. of parts.	For a typical longitudinal bulb flat HP 340*14 on the parallel mid-body. Slots top and bottom: 1000 mm weld length.	
	Criteria assessment	Simplification 0	Standardization 0
8	Self aligning interim products. Reduce need for high accuracy levels.	High level of accuracy required to slide webs easily over longitudinals on 1 <sup>st</sup> panel. High level of accuracy to slide upper longitudinals through webs.	
	Criteria assessment	Simplification 0	Standardization 0
9	Maximize the use of automated assembly lines	Does not use automatic twin fillet welding of longitudinals on panels.	
	Criteria assessment	Simplification 0	Standardization 0
10	Maximize current facilities. Applicable to current technology level.	Requires significant accuracy control development. Requires specialized web pulling and upper longitudinal slotting equipment.	
	Criteria assessment	Simplification 0	Standardization 0
11	Classification approval.	Requires design and approval of longitudinal slots.	
	Criteria assessment	Simplification 0	Standardization 0
<b>Total</b>		<b>4</b>	<b>5</b>

**Tab. 3.27. Assembly option evaluation for block assembly method 3-2f [2], [30]**

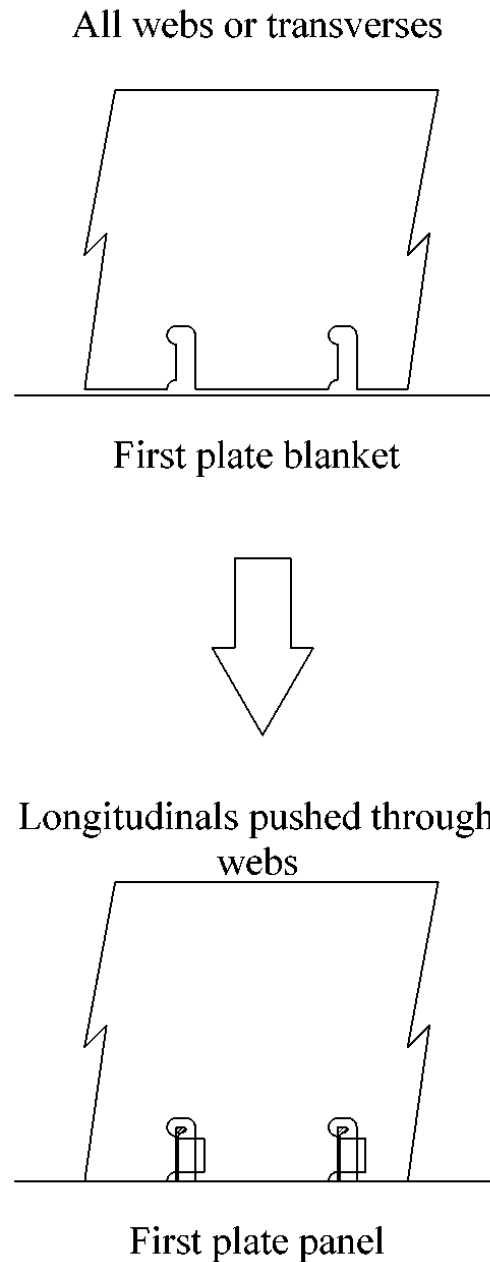
No.	Engineering Criteria	Method 3-2f	
1	Maximize downhand and automatic welding	Overhead welding of longitudinals into web slots.	
	Criteria assessment	Simplification 0	Standardization 0
2	Easy access to joints during assembly	Staging required to weld upper longitudinals onto slots in the webs.	
	Criteria assessment	Simplification 0	Standardization 0
3	Self supporting interim products	No	
	Criteria assessment	Simplification 0	Standardization 0
4	Minimize turning during assembly	One assembly turn of 1 <sup>st</sup> built up panel onto 2 <sup>nd</sup> plate blanket.	
	Criteria assessment	Simplification 1	Standardization 1
5	Simplify connections. Minimize variety.	Fitted slots for longitudinals on 1 <sup>st</sup> and 2 <sup>nd</sup> panels.	
	Criteria assessment	Simplification 1	Standardization 1
6	Maximize downhand fitting	Overhead fitting of longitudinals through slots in webs.	
	Criteria assessment	Simplification 0	Standardization 1
7	Minimize joint length. Reduce no. of parts.	For a typical longitudinal bulb flat HP 340*14 on the parallel mid-body. Slots top and bottom: 1000 mm weld length.	
	Criteria assessment	Simplification 1	Standardization 1
8	Self aligning interim products. Reduce need for high accuracy levels.	High level of accuracy required to slide webs easily over longitudinals on 1 <sup>st</sup> panel. High level of accuracy to slide upper longitudinals through webs.	
	Criteria assessment	Simplification 0	Standardization 0
9	Maximize the use of automated assembly lines	Does not use automatic twin fillet welding of longitudinals on panels.	
	Criteria assessment	Simplification 0	Standardization 0
10	Maximize current facilities. Applicable to current technology level.	Requires significant accuracy control development. Requires specialized web pulling and upper longitudinal slotting equipment.	
	Criteria assessment	Simplification 0	Standardization 0
11	Classification approval.	Requires design and approval of longitudinal slots.	
	Criteria assessment	Simplification 0	Standardization 0
<b>Total</b>		<b>3</b>	<b>4</b>

**Tab. 3.28. Assembly option evaluation for block assembly method 3-2g [2], [30]**

No.	Engineering Criteria	Method 3-2g	
1	Maximize downhand and automatic welding	Overhead welding of longitudinals into web slots. Overhead tacking of 2 <sup>nd</sup> plate blanket on 1 <sup>st</sup> built up panel.	
	Criteria assessment	Simplification 0	Standardization 0
2	Easy access to joints during assembly	Staging required to weld upper longitudinals onto slots in the webs. Staging required to tack 2 <sup>nd</sup> plate blanket to 1 <sup>st</sup> built up panel.	
	Criteria assessment	Simplification 0	Standardization 0
3	Self supporting interim products	No	
	Criteria assessment	Simplification 0	Standardization 0
4	Minimize turning during assembly	One turn of 2 <sup>nd</sup> plate blanket onto 1 <sup>st</sup> built up panel. One turn of full block to weld 2 <sup>nd</sup> plate blanket.	
	Criteria assessment	Simplification 0	Standardization 0
5	Simplify connections. Minimize variety.	Fitted slots for longitudinals on 1 <sup>st</sup> and 2 <sup>nd</sup> panels.	
	Criteria assessment	Simplification 1	Standardization 1
6	Maximize downhand fitting	Overhead fitting of longitudinals through slots in webs.	
	Criteria assessment	Simplification 0	Standardization 1
7	Minimize joint length. Reduce no. of parts.	For a typical longitudinal bulb flat HP 340*14 on the parallel mid-body. Slots top and bottom: 1000 mm weld length.	
	Criteria assessment	Simplification 1	Standardization 1
8	Self aligning interim products. Reduce need for high accuracy levels.	High level of accuracy required to slide webs easily over longitudinals on 1 <sup>st</sup> panel. High level of accuracy to slide upper longitudinals through webs.	
	Criteria assessment	Simplification 0	Standardization 0
9	Maximize the use of automated assembly lines	Does not use automatic twin fillet welding of longitudinals on panels.	
	Criteria assessment	Simplification 0	Standardization 0
10	Maximize current facilities. Applicable to current technology level.	Requires significant accuracy control development. Requires specialized web pulling and upper longitudinal slotting equipment.	
	Criteria assessment	Simplification 0	Standardization 0
11	Classification approval.	Requires design and approval of longitudinal slots.	
	Criteria assessment	Simplification 0	Standardization 0
<b>Total</b>		<b>2</b>	<b>3</b>

**Assembly options for principal block assembly method 4-1**

Figure 3.30 shows the principal block assembly method 4-1 adapted for bulb plate longitudinals, while figures 3.31 to 3.34 illustrate the seven options. The complementary option evaluation tables 3.29 to 3.35 are included as well.



**Fig. 3.30. Principal block assembly method 4-1 [2], [30]**

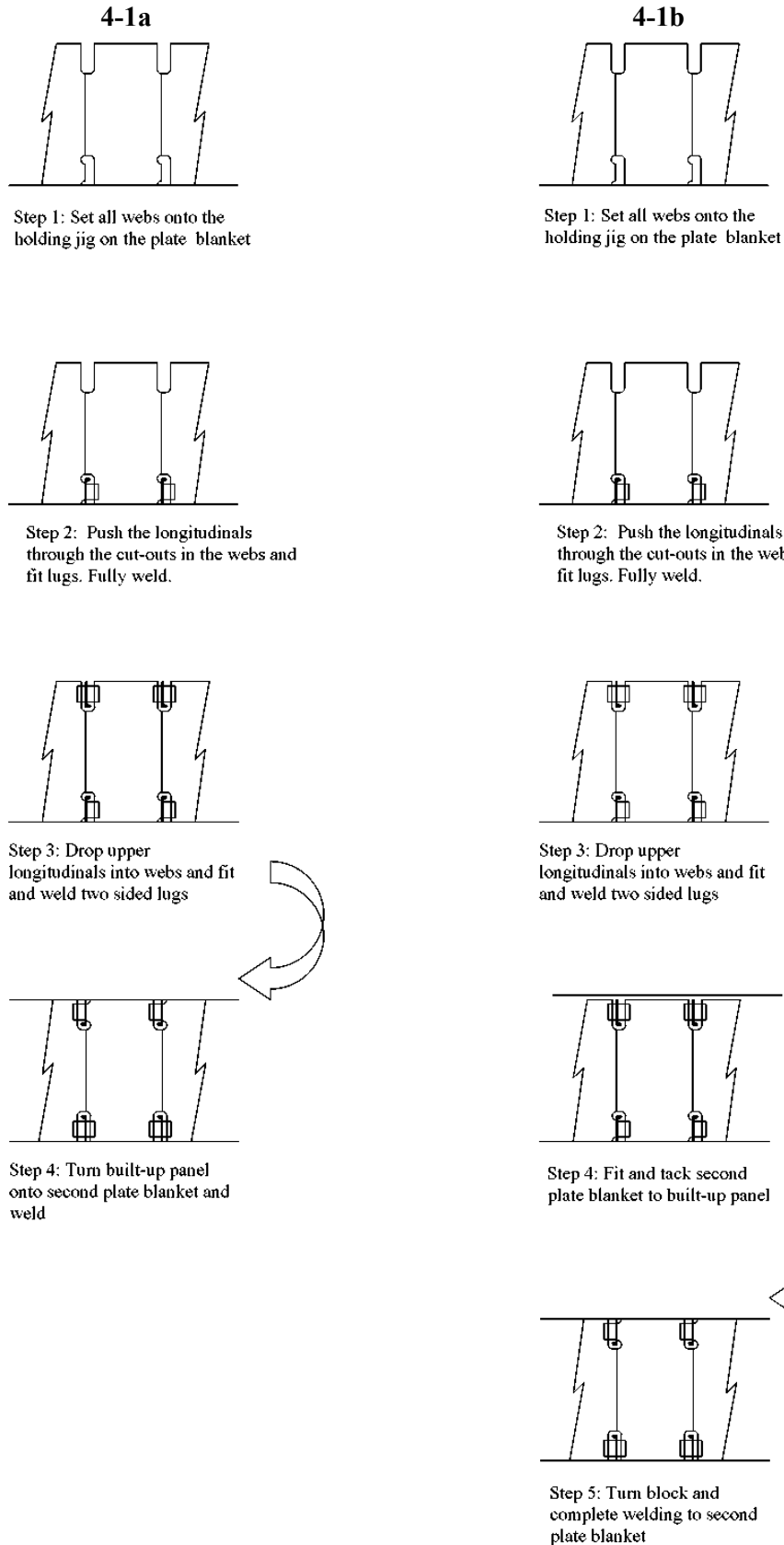


Fig. 3.31. Block assembly method 4-1a and 4-1b [2], [30]

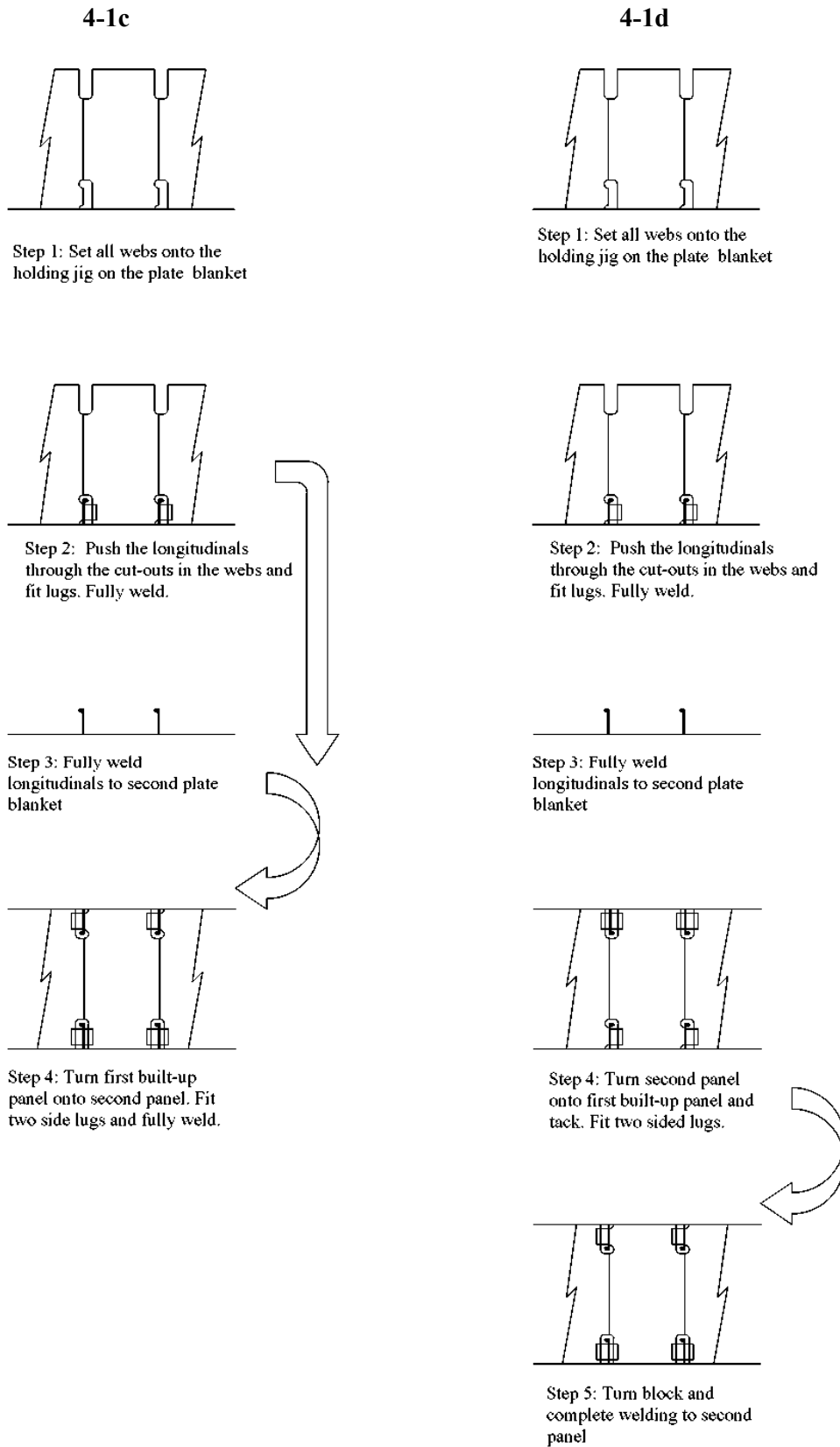


Fig. 3.32. Block assembly methods 4-1c and 4-1d [2], [30]

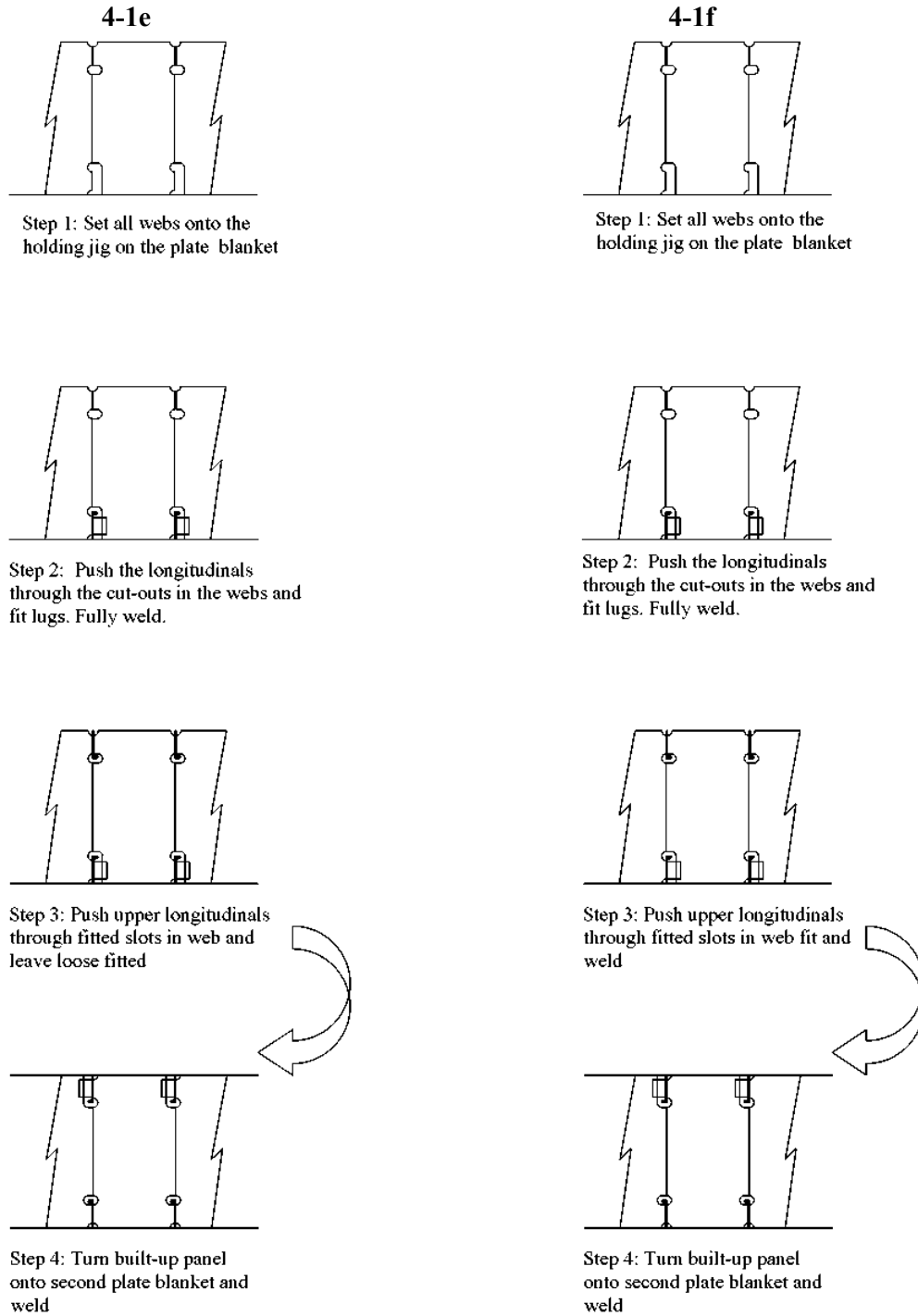
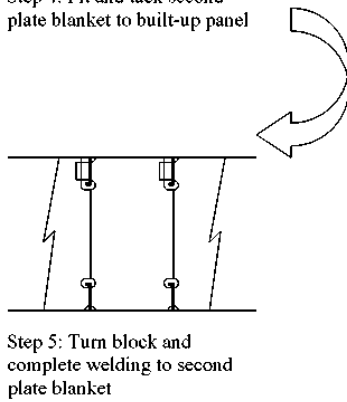
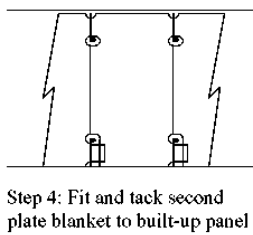
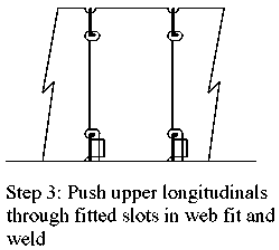
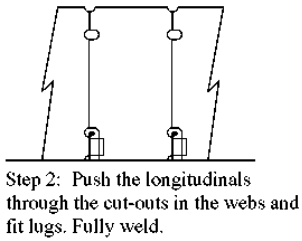
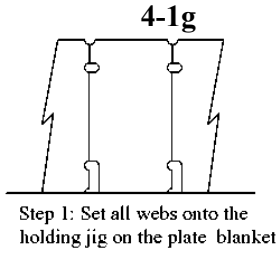


Fig. 3.33. Block assembly methods 4-1e and 4-1f [2], [30]





**Fig. 3.34. Block assembly method 4-1g [2], [30]**

**Tab. 3.29. Assembly option evaluation for block assembly method 4-1a [2], [30]**

No.	Engineering Criteria	Method 4-1a	
1	Maximize downhand and automatic welding	Overhead welding of longitudinals and lugs to webs.	
	Criteria assessment	Simplification 0	Standardization 0
2	Easy access to joints during assembly	Staging required at each web to fit longitudinals and lugs.	
	Criteria assessment	Simplification 0	Standardization 0
3	Self supporting interim products	No	
	Criteria assessment	Simplification 0	Standardization 0
4	Minimize turning during assembly	One assembly turn of built up 1 <sup>st</sup> panel onto 2 <sup>nd</sup> plate blanket.	
	Criteria assessment	Simplification 1	Standardization 1
5	Simplify connections. Minimize variety.	Cut outs with lugs top and bottom.	
	Criteria assessment	Simplification 1	Standardization 1
6	Maximize downhand fitting	Overhead fitting of 2 <sup>nd</sup> panel longitudinals and lugs into web cut outs.	
	Criteria assessment	Simplification 0	Standardization 0
7	Minimize joint length. Reduce no. of parts.	For a typical longitudinal bulb flat HP 340*14 on the parallel mid-body. One-sided lug: 950mm weld length; Double sided lug: 1400 mm weld length.	
	Criteria assessment	Simplification 0	Standardization 1
8	Self aligning interim products. Reduce need for high accuracy levels.	Longitudinal alignment at single lug cut-out. Minimum accuracy needed for fitting of longitudinals through webs.	
	Criteria assessment	Simplification 0	Standardization 1
9	Maximize the use of automated assembly lines	Does not use automatic twin fillet welding of longitudinals on panels.	
	Criteria assessment	Simplification 0	Standardization 0
10	Maximize current facilities. Applicable to current technology level.	Requires no technology development. Requires longitudinal pushing equipment.	
	Criteria assessment	Simplification 0	Standardization 0
11	Classification approval.	Within current technology level, all details approved.	
	Criteria assessment	Simplification 1	Standardization 1
<b>Total</b>		<b>3</b>	<b>5</b>

**Tab. 3.30. Assembly option evaluation for block assembly method 4-1b [2], [30]**

No.	Engineering Criteria	Method 4-1b	
1	Maximize downhand and automatic welding	Overhead welding of upper longitudinals to webs. Overhead tacking of plate blanket to built up panel.	
	Criteria assessment	Simplification 0	Standardization 0
2	Easy access to joints during assembly	Staging required at each web to fit longitudinals and lugs. Staging required to tack plate blanket to built up panel.	
	Criteria assessment	Simplification 0	Standardization 0
3	Self supporting interim products	No	
	Criteria assessment	Simplification 0	Standardization 0
4	Minimize turning during assembly	One turn of 2 <sup>nd</sup> plate blanket onto built up panel. One turn of full block to weld 2 <sup>nd</sup> plate blanket.	
	Criteria assessment	Simplification 0	Standardization 0
5	Simplify connections. Minimize variety.	Cut outs with lugs top and bottom.	
	Criteria assessment	Simplification 1	Standardization 1
6	Maximize downhand fitting	Overhead fitting of 2 <sup>nd</sup> panel longitudinals and lugs into web cut outs. Overhead fitting of 2 <sup>nd</sup> plate blanket to 1 <sup>st</sup> built up panel.	
	Criteria assessment	Simplification 0	Standardization 0
7	Minimize joint length. Reduce no. of parts.	For a typical longitudinal bulb flat HP 340*14 on the parallel mid-body. One-sided lug: 950mm weld length; Double sided lug: 1400 mm weld length.	
	Criteria assessment	Simplification 0	Standardization 1
8	Self aligning interim products. Reduce need for high accuracy levels.	Longitudinal alignment at single lug cut-out. Minimum accuracy needed for fitting of longitudinals through webs.	
	Criteria assessment	Simplification 0	Standardization 1
9	Maximize the use of automated assembly lines	Does not use automatic twin fillet welding of longitudinals on panels.	
	Criteria assessment	Simplification 0	Standardization 0
10	Maximize current facilities. Applicable to current technology level.	Requires no technology development. Requires longitudinal pushing equipment.	
	Criteria assessment	Simplification 0	Standardization 0
11	Classification approval.	Within current technology level, all details approved.	
	Criteria assessment	Simplification 1	Standardization 1
<b>Total</b>		<b>2</b>	<b>4</b>

**Tab. 3.31. Assembly option evaluation for block assembly method 4-1c [2], [30]**

No.	Engineering Criteria	Method 4-1c	
1	Maximize downhand and automatic welding	No overhead welding.	
	Criteria assessment	Simplification 1	Standardization 1
2	Easy access to joints during assembly	Simplified access to assembly joints.	
	Criteria assessment	Simplification 1	Standardization 1
3	Self supporting interim products	Yes	
	Criteria assessment	Simplification 1	Standardization 1
4	Minimize turning during assembly	One assembly turn of 1st built up panel onto 2 <sup>nd</sup> plate panel.	
	Criteria assessment	Simplification 1	Standardization 1
5	Simplify connections. Minimize variety.	Cut outs with lugs top and bottom.	
	Criteria assessment	Simplification 1	Standardization 1
6	Maximize downhand fitting	All downhand fitting.	
	Criteria assessment	Simplification 1	Standardization 1
7	Minimize joint length. Reduce no. of parts.	For a typical longitudinal bulb flat HP 340*14 on the parallel mid-body. One-sided lug: 950mm weld length; Double sided lug: 1400 mm weld length.	
	Criteria assessment	Simplification 0	Standardization 1
8	Self aligning interim products. Reduce need for high accuracy levels.	Longitudinal alignment at single lug cut-out. Minimum accuracy needed for fitting of 1 <sup>st</sup> built up panel to 2 <sup>nd</sup> panel.	
	Criteria assessment	Simplification 1	Standardization 1
9	Maximize the use of automated assembly lines	Uses automatic twin fillet welding of longitudinals on 2 <sup>nd</sup> panel only.	
	Criteria assessment	Simplification 0	Standardization 0
10	Maximize current facilities. Applicable to current technology level.	Uses automatic twin fillet welding on 2 <sup>nd</sup> panel. Requires longitudinal pushing equipment.	
	Criteria assessment	Simplification 0	Standardization 0
11	Classification approval.	Within current technology level, all details approved.	
	Criteria assessment	Simplification 1	Standardization 1
<b>Total</b>		<b>8</b>	<b>9</b>

**Tab. 3.32. Assembly option evaluation for block assembly method 4-1d [2], [30]**

No.	Engineering Criteria	Method 4-1d	
1	Maximize downhand and automatic welding	Overhead tacking of 2 <sup>nd</sup> plate panel to 1 <sup>st</sup> built up panel.	
	Criteria assessment	Simplification 0	Standardization 0
2	Easy access to joints during assembly	Staging required at webs to tack 2 <sup>nd</sup> panel to 1 <sup>st</sup> built up panel.	
	Criteria assessment	Simplification 0	Standardization 0
3	Self supporting interim products	Yes	
	Criteria assessment	Simplification 0	Standardization 1
4	Minimize turning during assembly	One turn of 2 <sup>nd</sup> plate panel onto 1 <sup>st</sup> built up panel. One turn of full block to weld 2 <sup>nd</sup> plate panel.	
	Criteria assessment	Simplification 1	Standardization 1
5	Simplify connections. Minimize variety.	Cut outs with lugs top and bottom.	
	Criteria assessment	Simplification 1	Standardization 1
6	Maximize downhand fitting	Overhead fitting of 2 <sup>nd</sup> plate blanket and longitudinal lugs to 1 <sup>st</sup> built up panel.	
	Criteria assessment	Simplification 0	Standardization 0
7	Minimize joint length. Reduce no. of parts.	For a typical longitudinal bulb flat HP 340*14 on the parallel mid-body. One-sided lug: 950mm weld length; Double sided lug: 1400 mm weld length.	
	Criteria assessment	Simplification 0	Standardization 1
8	Self aligning interim products. Reduce need for high accuracy levels.	Longitudinal alignment at single lug cut-out. Minimum accuracy needed for fitting of 2 <sup>nd</sup> panel to 1 <sup>st</sup> built up panel.	
	Criteria assessment	Simplification 0	Standardization 0
9	Maximize the use of automated assembly lines	Uses automatic twin fillet welding of longitudinals on 2 <sup>nd</sup> panel only.	
	Criteria assessment	Simplification 0	Standardization 0
10	Maximize current facilities. Applicable to current technology level.	Uses automatic twin fillet welding on 2 <sup>nd</sup> panel. Requires longitudinal pushing equipment.	
	Criteria assessment	Simplification 0	Standardization 0
11	Classification approval.	Within current technology level, all details approved.	
	Criteria assessment	Simplification 1	Standardization 1
<b>Total</b>		<b>2</b>	<b>4</b>

**Tab. 3.33. Assembly option evaluation for block assembly method 4-1e [2], [30]**

No.	Engineering Criteria	Method 4-1e	
1	Maximize downhand and automatic welding	No overhead welding.	
	Criteria assessment	Simplification 1	Standardization 1
2	Easy access to joints during assembly	Staging required to access upper longitudinals during slotting to webs.	
	Criteria assessment	Simplification 0	Standardization 0
3	Self supporting interim products	No	
	Criteria assessment	Simplification 0	Standardization 0
4	Minimize turning during assembly	One assembly turn of 1 <sup>st</sup> built up panel onto 2 <sup>nd</sup> plate blanket.	
	Criteria assessment	Simplification 1	Standardization 1
5	Simplify connections. Minimize variety.	Cut outs with lugs top at the top. Fitted slots at the bottom.	
	Criteria assessment	Simplification 0	Standardization 0
6	Maximize downhand fitting	All downhand fitting.	
	Criteria assessment	Simplification 1	Standardization 1
7	Minimize joint length. Reduce no. of parts.	For a typical longitudinal bulb flat HP 340*14 on the parallel mid-body. One-sided lug: 950mm weld length; Slot: 500 mm weld length.	
	Criteria assessment	Simplification 1	Standardization 0
8	Self aligning interim products. Reduce need for high accuracy levels.	Longitudinal alignment at single lug cut-out. High accuracy required for sliding longitudinals through webs.	
	Criteria assessment	Simplification 0	Standardization 0
9	Maximize the use of automated assembly lines	Does not use automatic twin fillet welding of longitudinals on panels.	
	Criteria assessment	Simplification 0	Standardization 0
10	Maximize current facilities. Applicable to current technology level.	Requires significant accuracy control development. Requires upper and lower longitudinal sliding equipment.	
	Criteria assessment	Simplification 0	Standardization 0
11	Classification approval.	Requires design and approval of longitudinal slots.	
	Criteria assessment	Simplification 0	Standardization 0
<b>Total</b>		<b>4</b>	<b>3</b>

**Tab. 3.34. Assembly option evaluation for block assembly method 4-1f [2], [30]**

No.	Engineering Criteria	Method 4-1f	
1	Maximize downhand and automatic welding	Overhead welding of longitudinals into web slots.	
	Criteria assessment	Simplification 0	Standardization 0
2	Easy access to joints during assembly	Staging required to weld upper longitudinals into slots in the webs.	
	Criteria assessment	Simplification 0	Standardization 0
3	Self supporting interim products	No	
	Criteria assessment	Simplification 0	Standardization 0
4	Minimize turning during assembly	One assembly turn of 1 <sup>st</sup> built up panel onto 2 <sup>nd</sup> plate blanket.	
	Criteria assessment	Simplification 1	Standardization 1
5	Simplify connections. Minimize variety.	Cut outs with lugs top at the top. Fitted slots at the bottom.	
	Criteria assessment	Simplification 0	Standardization 0
6	Maximize downhand fitting	Overhead fitting of longitudinals in slots in webs.	
	Criteria assessment	Simplification 0	Standardization 0
7	Minimize joint length. Reduce no. of parts.	For a typical longitudinal bulb flat HP 340*14 on the parallel mid-body. One-sided lug: 950mm weld length; Slot: 500 mm weld length.	
	Criteria assessment	Simplification 1	Standardization 0
8	Self aligning interim products. Reduce need for high accuracy levels.	Longitudinal alignment at single lug cut-out. High accuracy required for sliding longitudinals through webs.	
	Criteria assessment	Simplification 0	Standardization 0
9	Maximize the use of automated assembly lines	Does not use automatic twin fillet welding of longitudinals on panels.	
	Criteria assessment	Simplification 0	Standardization 0
10	Maximize current facilities. Applicable to current technology level.	Requires significant accuracy control development. Requires upper and lower longitudinal sliding equipment.	
	Criteria assessment	Simplification 0	Standardization 0
11	Classification approval.	Requires design and approval of longitudinal slots.	
	Criteria assessment	Simplification 0	Standardization 0
<b>Total</b>		<b>2</b>	<b>1</b>

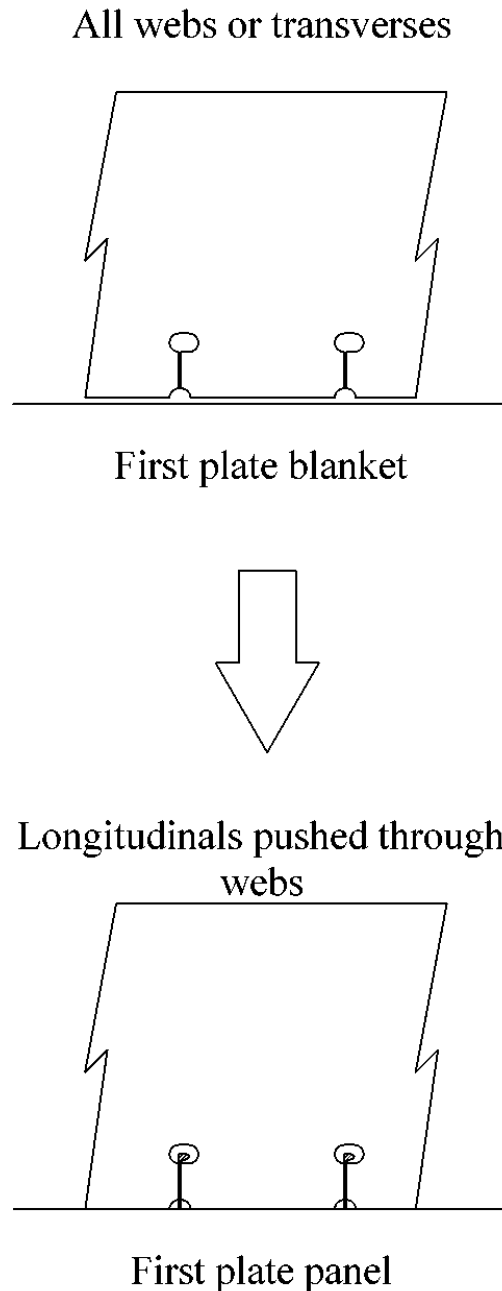
**Tab. 3.35. Assembly option evaluation for block assembly method 4-1g [2], [30]**

No.	Engineering Criteria	Method 4-1g	
1	Maximize downhand and automatic welding	Overhead welding of longitudinals into web slots. Overhead tacking of 2 <sup>nd</sup> plate blanket to 1 <sup>st</sup> built up panel.	
	Criteria assessment	Simplification 0	Standardization 0
2	Easy access to joints during assembly	Staging required to weld upper longitudinals into slots in the webs. Staging required to tack 2 <sup>nd</sup> plate blanket to 1 <sup>st</sup> built up panel.	
	Criteria assessment	Simplification 0	Standardization 0
3	Self supporting interim products	No	
	Criteria assessment	Simplification 0	Standardization 0
4	Minimize turning during assembly	One turn of 2 <sup>nd</sup> plate blanket onto 1 <sup>st</sup> built up panel. One turn of full block to weld 2 <sup>nd</sup> plate blanket.	
	Criteria assessment	Simplification 0	Standardization 0
5	Simplify connections. Minimize variety.	Cut outs with lugs top at the top. Fitted slots at the bottom.	
	Criteria assessment	Simplification 0	Standardization 0
6	Maximize downhand fitting	Overhead fitting of longitudinals in slots in webs. Overhead fitting of 2 <sup>nd</sup> plate blanket to 1 <sup>st</sup> built up panel.	
	Criteria assessment	Simplification 0	Standardization 0
7	Minimize joint length. Reduce no. of parts.	For a typical longitudinal bulb flat HP 340*14 on the parallel mid-body. One-sided lug: 950mm weld length; Slot: 500 mm weld length.	
	Criteria assessment	Simplification 1	Standardization 0
8	Self aligning interim products. Reduce need for high accuracy levels.	Longitudinal alignment at single lug cut-out. High accuracy required for sliding longitudinals through webs.	
	Criteria assessment	Simplification 0	Standardization 0
9	Maximize the use of automated assembly lines	Does not use automatic twin fillet welding of longitudinals on panels.	
	Criteria assessment	Simplification 0	Standardization 0
10	Maximize current facilities. Applicable to current technology level.	Requires significant accuracy control development. Requires upper and lower longitudinal sliding equipment.	
	Criteria assessment	Simplification 0	Standardization 0
11	Classification approval.	Requires design and approval of longitudinal slots.	
	Criteria assessment	Simplification 0	Standardization 0
<b>Total</b>		<b>1</b>	<b>0</b>



**Assembly options for principal block assembly method 4-2**

Figure 3.35 shows the principal block assembly method 4-2 adapted for bulb plate longitudinals, while figures 3.36 to 3.39 illustrate the seven options. The complementary option evaluation tables 3.36 to 3.42 are included as well.



**Fig. 3.35. Principal block assembly method 4-2 [2], [30]**

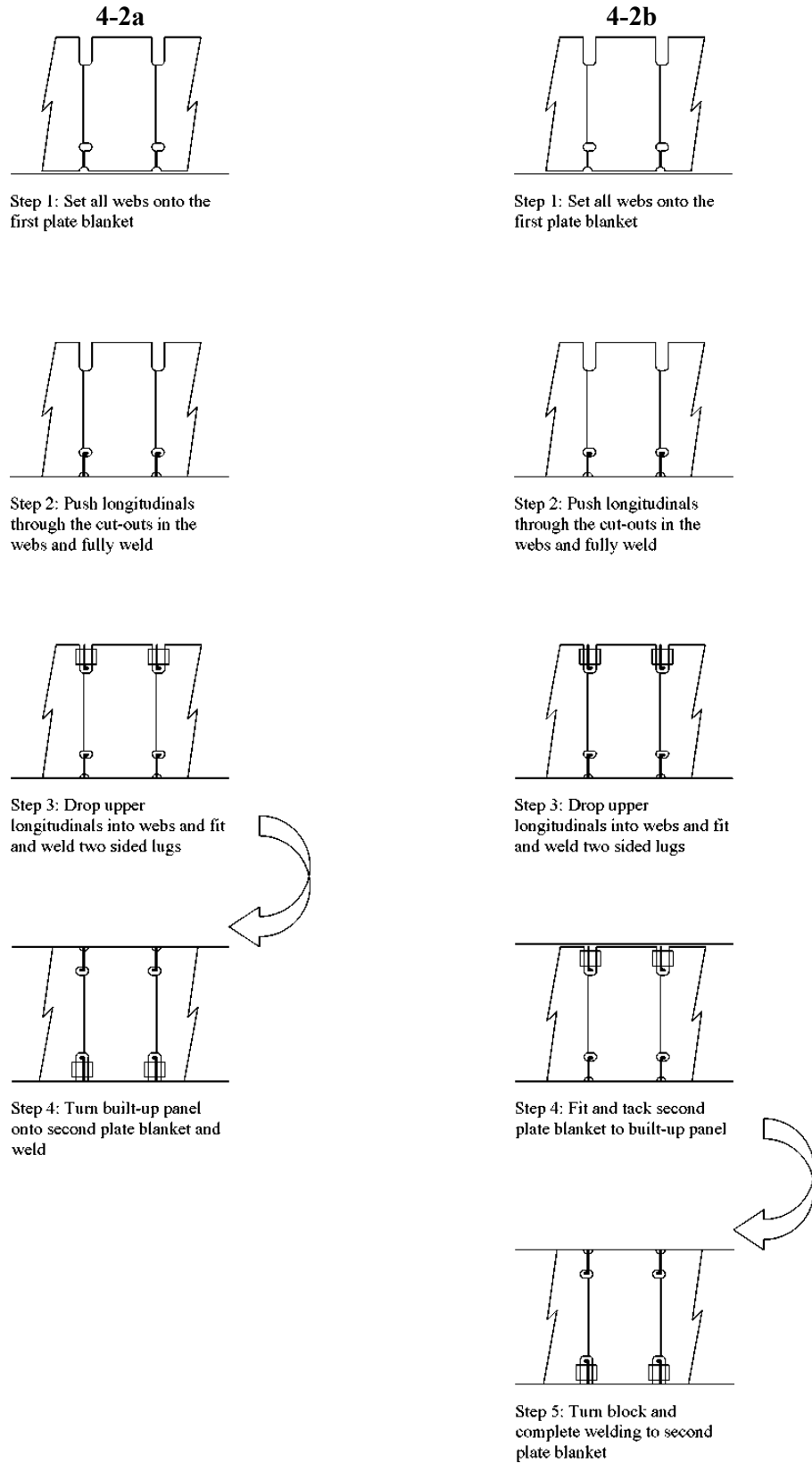
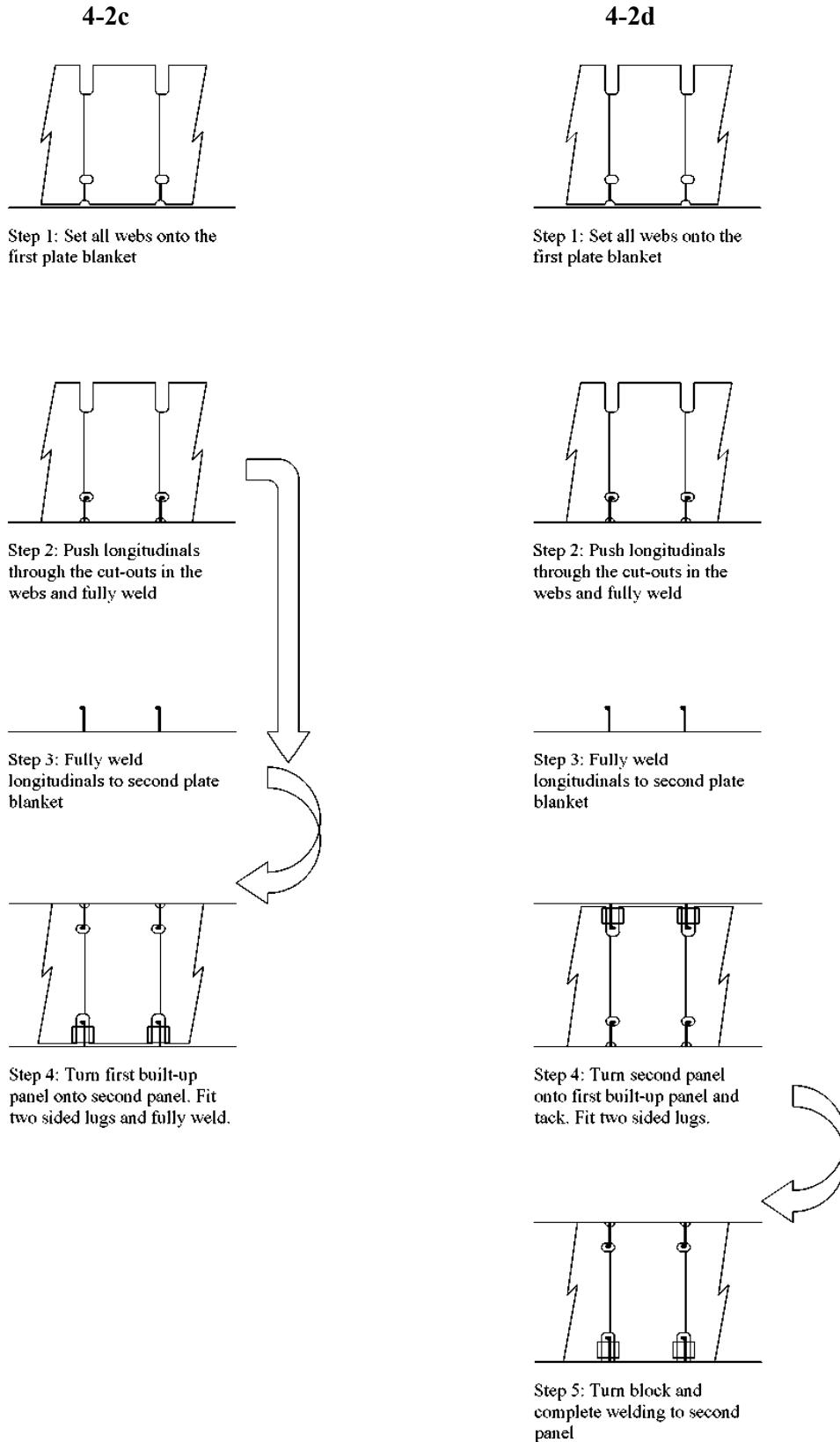
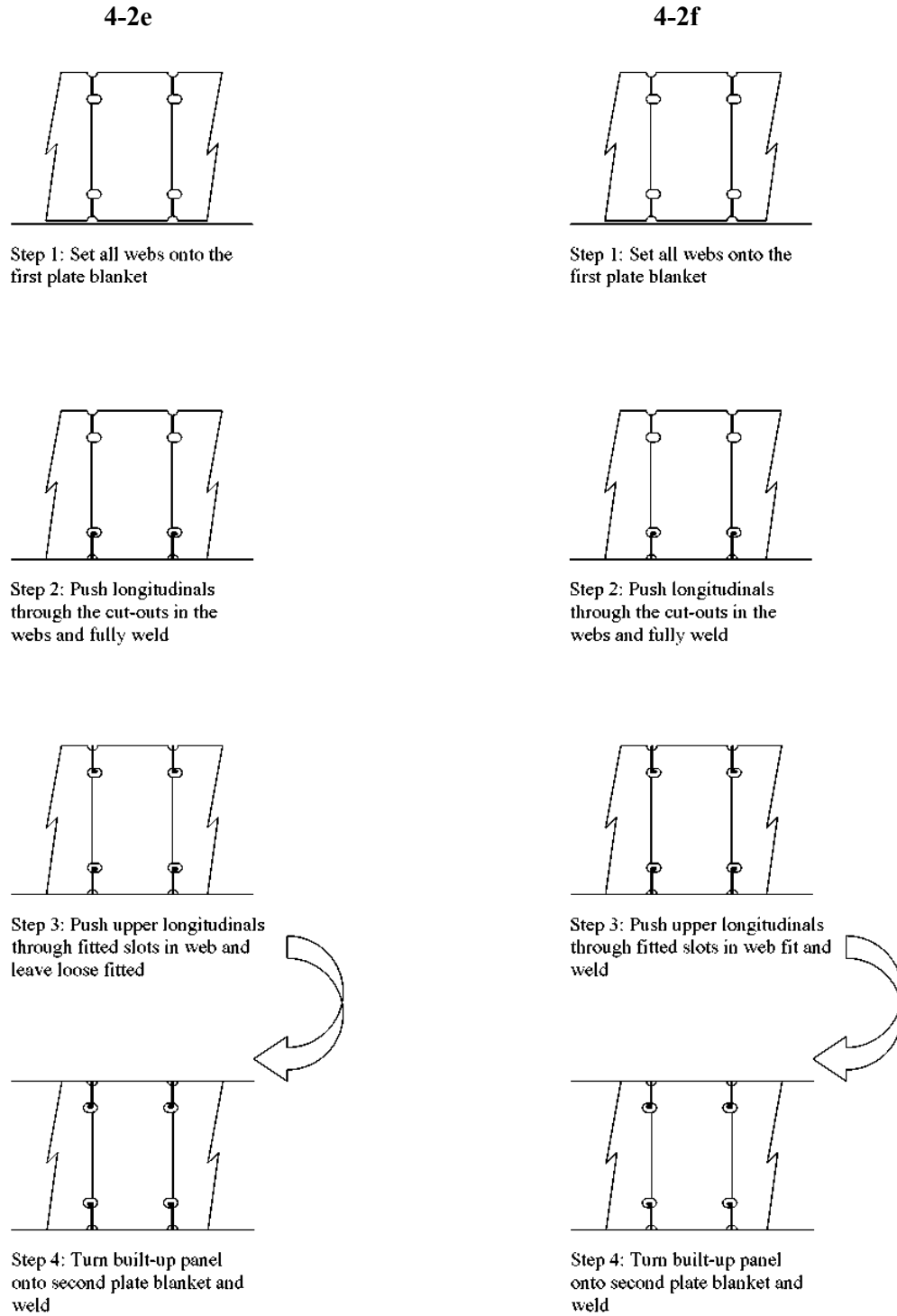


Fig. 3.36. Block assembly methods 4-2a and 4-2b [2], [30]

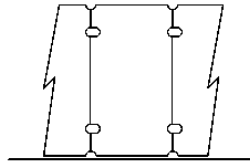


**Fig. 3.37. Block assembly methods 4-2c and 4-2d [2], [30]**

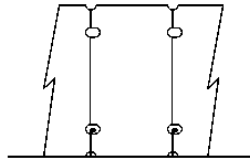


**Fig. 3.38. Block assembly methods 4-2e and 4-2f [2], [30]**

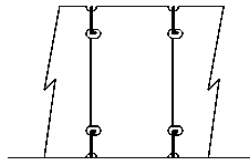
## 4-2g



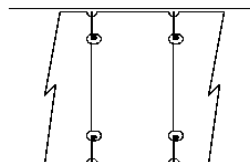
Step 1: Set all webs onto the first plate blanket



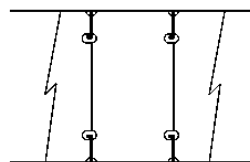
Step 2: Push longitudinals through the cut-outs in the webs and fully weld



Step 3: Push upper longitudinals through fitted slots in web fit and weld



Step 4: Fit and tack second plate blanket to built-up panel



Step 5: Turn block and complete welding to second plate blanket

Fig. 3.39. Block assembly method 4-2g [2], [30]

**Tab. 3.36. Assembly option evaluation for block assembly method 4-2a [2], [30]**

No.	Engineering Criteria	Method 4-2a	
1	Maximize downhand and automatic welding	Overhead welding of longitudinals and lugs in webs.	
	Criteria assessment	Simplification 0	Standardization 0
2	Easy access to joints during assembly	Staging required at each web to fit longitudinals and lugs.	
	Criteria assessment	Simplification 0	Standardization 0
3	Self supporting interim products	No	
	Criteria assessment	Simplification 0	Standardization 0
4	Minimize turning during assembly	One assembly turn of built up 1 <sup>st</sup> panel onto second plate blanket.	
	Criteria assessment	Simplification 1	Standardization 1
5	Simplify connections. Minimize variety.	Fitted slots for longitudinals on 1 <sup>st</sup> panel. Cut outs with lugs both sides on 2 <sup>nd</sup> panel.	
	Criteria assessment	Simplification 0	Standardization 0
6	Maximize downhand fitting	Overhead fitting of 2 <sup>nd</sup> panel longitudinals and lugs into web cut-outs.	
	Criteria assessment	Simplification 0	Standardization 0
7	Minimize joint length. Reduce no. of parts.	For a typical longitudinal bulb flat HP 340*14 on the parallel mid-body. Double-sided lug: 1400mm weld length; Slot: 500 mm weld length.	
	Criteria assessment	Simplification 0	Standardization 0
8	Self aligning interim products. Reduce need for high accuracy levels.	High level of accuracy required to slide longitudinals through webs.	
	Criteria assessment	Simplification 0	Standardization 0
9	Maximize the use of automated assembly lines	Does not use automatic twin fillet welding of longitudinals on panels.	
	Criteria assessment	Simplification 0	Standardization 0
10	Maximize current facilities. Applicable to current technology level.	Requires significant accuracy control development. Requires specialized longitudinal pushing equipment.	
	Criteria assessment	Simplification 0	Standardization 0
11	Classification approval.	Requires design and approval of longitudinal slots.	
	Criteria assessment	Simplification 0	Standardization 0
<b>Total</b>		<b>1</b>	<b>1</b>

**Tab. 3.37. Assembly option evaluation for block assembly method 4-2b [2], [30]**

No.	Engineering Criteria	Method 4-2b	
1	Maximize downhand and automatic welding	Overhead welding of upper longitudinals to webs. Overhead tacking of plate blanket to built up panel.	
	Criteria assessment	Simplification 0	Standardization 0
2	Easy access to joints during assembly	Staging required at each web to fit longitudinals and lugs. Staging required to tack plate blanket to built up panel.	
	Criteria assessment	Simplification 0	Standardization 0
3	Self supporting interim products	No	
	Criteria assessment	Simplification 0	Standardization 0
4	Minimize turning during assembly	One turn of 2 <sup>nd</sup> plate blanket onto 1 <sup>st</sup> built up panel. One turn of full block to weld 2 <sup>nd</sup> plate blanket.	
	Criteria assessment	Simplification 0	Standardization 0
5	Simplify connections. Minimize variety.	Fitted slots for longitudinals on 1 <sup>st</sup> panel. Cut outs with lugs both sides on 2 <sup>nd</sup> panel.	
	Criteria assessment	Simplification 0	Standardization 0
6	Maximize downhand fitting	Overhead fitting of 2 <sup>nd</sup> panel longitudinals and lugs into web cut-outs. Overhead fitting of 2 <sup>nd</sup> plate blanket to first built up panel.	
	Criteria assessment	Simplification 0	Standardization 0
7	Minimize joint length. Reduce no. of parts.	For a typical longitudinal bulb flat HP 340*14 on the parallel mid-body. Double-sided lug: 1400mm weld length; Slot: 500 mm weld length.	
	Criteria assessment	Simplification 0	Standardization 0
8	Self aligning interim products. Reduce need for high accuracy levels.	High level of accuracy required to slide longitudinals through webs. No self alignment with open cut outs on 2 <sup>nd</sup> panel.	
	Criteria assessment	Simplification 0	Standardization 0
9	Maximize the use of automated assembly lines	Does not use automatic twin fillet welding of longitudinals on panels.	
	Criteria assessment	Simplification 0	Standardization 0
10	Maximize current facilities. Applicable to current technology level.	Requires significant accuracy control development. Requires specialized longitudinal pushing equipment.	
	Criteria assessment	Simplification 0	Standardization 0
11	Classification approval.	Requires design and approval of longitudinal slots.	
	Criteria assessment	Simplification 0	Standardization 0
<b>Total</b>		<b>0</b>	<b>0</b>

**Tab. 3.38. Assembly option evaluation for block assembly method 4-2c [2], [30]**

No.	Engineering Criteria	Method 4-2c	
1	Maximize downhand and automatic welding	No overhead welding.	
	Criteria assessment	Simplification 1	Standardization 1
2	Easy access to joints during assembly	Simplified access to assembly joints.	
	Criteria assessment	Simplification 1	Standardization 1
3	Self supporting interim products	Yes	
	Criteria assessment	Simplification 1	Standardization 1
4	Minimize turning during assembly	One assembly turn of 1st built up panel onto 2 <sup>nd</sup> plate panel.	
	Criteria assessment	Simplification 1	Standardization 1
5	Simplify connections. Minimize variety.	Fitted slots for longitudinals on 1 <sup>st</sup> panel. Cut outs with lugs both sides on 2 <sup>nd</sup> panel.	
	Criteria assessment	Simplification 0	Standardization 0
6	Maximize downhand fitting	All downhand fitting.	
	Criteria assessment	Simplification 1	Standardization 1
7	Minimize joint length. Reduce no. of parts.	For a typical longitudinal bulb flat HP 340*14 on the parallel mid-body. Double-sided lug: 1400mm weld length; Slot: 500 mm weld length.	
	Criteria assessment	Simplification 0	Standardization 0
8	Self aligning interim products. Reduce need for high accuracy levels.	High level of accuracy required to slide longitudinals through webs. No self alignment with open cut outs on 2 <sup>nd</sup> panel.	
	Criteria assessment	Simplification 0	Standardization 0
9	Maximize the use of automated assembly lines	Uses automatic twin fillet welding of longitudinals on 2 <sup>nd</sup> panel.	
	Criteria assessment	Simplification 0	Standardization 0
10	Maximize current facilities. Applicable to current technology level.	Utilizes automatic twin fillet welding on 2 <sup>nd</sup> panel. Requires longitudinal pushing equipment.	
	Criteria assessment	Simplification 0	Standardization 0
11	Classification approval.	Requires design and approval of longitudinal slots.	
	Criteria assessment	Simplification 0	Standardization 0
<b>Total</b>		<b>5</b>	<b>5</b>



**Tab. 3.39. Assembly option evaluation for block assembly method 4-2d [2], [30]**

No.	Engineering Criteria	Method 4-2d	
1	Maximize downhand and automatic welding	Overhead tacking of 2 <sup>nd</sup> plate panel to built up panel.	
	Criteria assessment	Simplification 0	Standardization 0
2	Easy access to joints during assembly	Staging required at web to tack 2 <sup>nd</sup> panel to 1 <sup>st</sup> built up panel.	
	Criteria assessment	Simplification 0	Standardization 0
3	Self supporting interim products	Yes	
	Criteria assessment	Simplification 0	Standardization 1
4	Minimize turning during assembly	One turn of 2 <sup>nd</sup> plate panel onto 1 <sup>st</sup> built up panel. One turn of full block to weld 2 <sup>nd</sup> plate panel.	
	Criteria assessment	Simplification 0	Standardization 0
5	Simplify connections. Minimize variety.	Fitted slots for longitudinals on 1 <sup>st</sup> panel. Cut outs with lugs both sides on 2 <sup>nd</sup> panel.	
	Criteria assessment	Simplification 0	Standardization 0
6	Maximize downhand fitting	Overhead fitting of 2 <sup>nd</sup> plate blanket and longitudinal lugs to 1 <sup>st</sup> built up panel.	
	Criteria assessment	Simplification 0	Standardization 0
7	Minimize joint length. Reduce no. of parts.	For a typical longitudinal bulb flat HP 340*14 on the parallel mid-body. Double-sided lug: 1400mm weld length; Slot: 500 mm weld length.	
	Criteria assessment	Simplification 0	Standardization 0
8	Self aligning interim products. Reduce need for high accuracy levels.	High level of accuracy required to slide longitudinals through webs. No self alignment with open cut outs on 2 <sup>nd</sup> panel.	
	Criteria assessment	Simplification 0	Standardization 0
9	Maximize the use of automated assembly lines	Uses automatic twin fillet welding of longitudinals on 2 <sup>nd</sup> panel.	
	Criteria assessment	Simplification 0	Standardization 0
10	Maximize current facilities. Applicable to current technology level.	Utilizes automatic twin fillet welding on 2 <sup>nd</sup> panel. Requires longitudinal pushing equipment.	
	Criteria assessment	Simplification 0	Standardization 0
11	Classification approval.	Requires design and approval of longitudinal slots.	
	Criteria assessment	Simplification 0	Standardization 0
<b>Total</b>		<b>0</b>	<b>1</b>

**Tab. 3.40. Assembly option evaluation for block assembly method 4-2e [2], [30]**

No.	Engineering Criteria	Method 4-2e	
1	Maximize downhand and automatic welding	No overhead welding.	
	Criteria assessment	Simplification 1	Standardization 1
2	Easy access to joints during assembly	Staging required to access upper longitudinals during sliding through webs.	
	Criteria assessment	Simplification 0	Standardization 0
3	Self supporting interim products	No	
	Criteria assessment	Simplification 0	Standardization 0
4	Minimize turning during assembly	One assembly turn of 1 <sup>st</sup> built up panel onto 2 <sup>nd</sup> plate blanket.	
	Criteria assessment	Simplification 1	Standardization 1
5	Simplify connections. Minimize variety.	Fitted slots for longitudinals 1 <sup>st</sup> and 2 <sup>nd</sup> panels.	
	Criteria assessment	Simplification 1	Standardization 1
6	Maximize downhand fitting	Overhead fitting of longitudinal through slots in webs.	
	Criteria assessment	Simplification 0	Standardization 1
7	Minimize joint length. Reduce no. of parts.	For a typical longitudinal bulb flat HP 340*14 on the parallel mid-body. Upper and lower slots: 1000 mm weld length.	
	Criteria assessment	Simplification 1	Standardization 1
8	Self aligning interim products. Reduce need for high accuracy levels.	High level of accuracy required to slide longitudinals through webs top and bottom.	
	Criteria assessment	Simplification 0	Standardization 0
9	Maximize the use of automated assembly lines	Does not use automatic twin fillet welding of longitudinals on panels.	
	Criteria assessment	Simplification 0	Standardization 0
10	Maximize current facilities. Applicable to current technology level.	Requires significant accuracy control development. Requires specialized upper and lower longitudinal pushing equipment.	
	Criteria assessment	Simplification 0	Standardization 0
11	Classification approval.	Requires design and approval of longitudinal slots.	
	Criteria assessment	Simplification 0	Standardization 0
<b>Total</b>		<b>4</b>	<b>5</b>

**Tab. 3.41. Assembly option evaluation for block assembly method 4-2f [2], [30]**

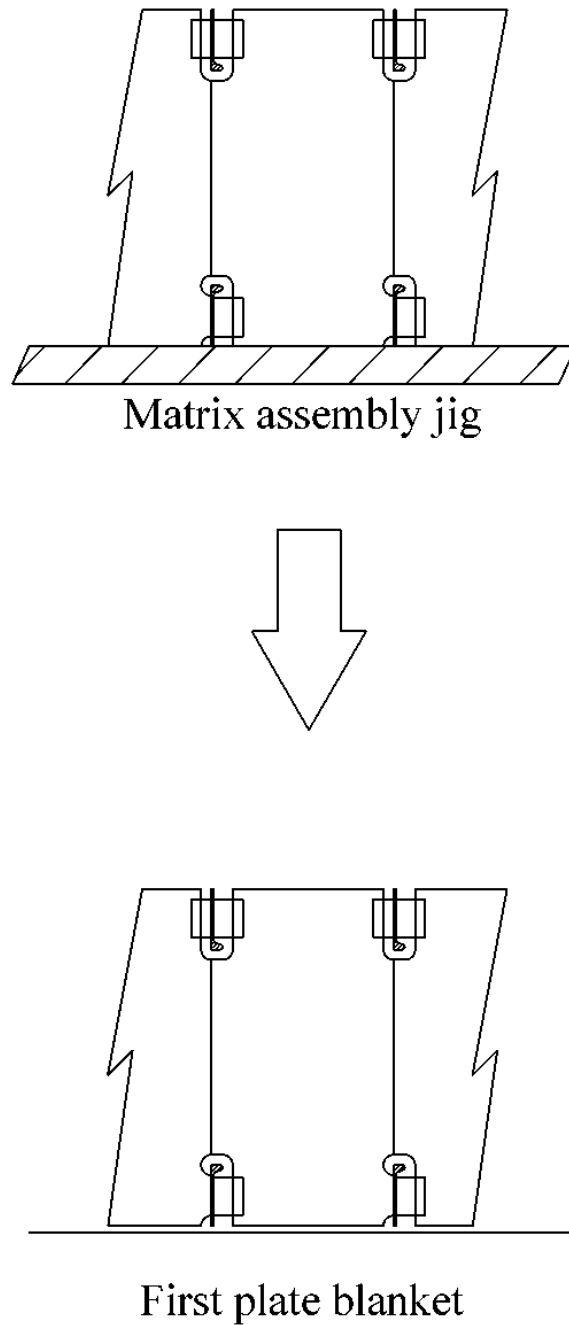
No.	Engineering Criteria	Method 4-2f	
1	Maximize downhand and automatic welding	Overhead welding of longitudinals into web slots.	
	Criteria assessment	Simplification 0	Standardization 0
2	Easy access to joints during assembly	Staging required to weld upper longitudinals into slots in the webs.	
	Criteria assessment	Simplification 0	Standardization 0
3	Self supporting interim products	No	
	Criteria assessment	Simplification 0	Standardization 0
4	Minimize turning during assembly	One assembly turn of 1 <sup>st</sup> built up panel onto 2 <sup>nd</sup> plate blanket.	
	Criteria assessment	Simplification 1	Standardization 1
5	Simplify connections. Minimize variety.	Fitted slots for longitudinals 1 <sup>st</sup> and 2 <sup>nd</sup> panels.	
	Criteria assessment	Simplification 1	Standardization 1
6	Maximize downhand fitting	Overhead fitting of longitudinal through slots in webs.	
	Criteria assessment	Simplification 0	Standardization 1
7	Minimize joint length. Reduce no. of parts.	For a typical longitudinal bulb flat HP 340*14 on the parallel mid-body. Upper and lower slots: 1000 mm weld length.	
	Criteria assessment	Simplification 1	Standardization 1
8	Self aligning interim products. Reduce need for high accuracy levels.	High level of accuracy required to slide longitudinals through webs top and bottom.	
	Criteria assessment	Simplification 0	Standardization 0
9	Maximize the use of automated assembly lines	Does not use automatic twin fillet welding of longitudinals on panels.	
	Criteria assessment	Simplification 0	Standardization 0
10	Maximize current facilities. Applicable to current technology level.	Requires significant accuracy control development. Requires specialized upper and lower longitudinal pushing equipment.	
	Criteria assessment	Simplification 0	Standardization 0
11	Classification approval.	Requires design and approval of longitudinal slots.	
	Criteria assessment	Simplification 0	Standardization 0
<b>Total</b>		<b>3</b>	<b>4</b>

**Tab. 3.42. Assembly option evaluation for block assembly method 4-2g [2], [30]**

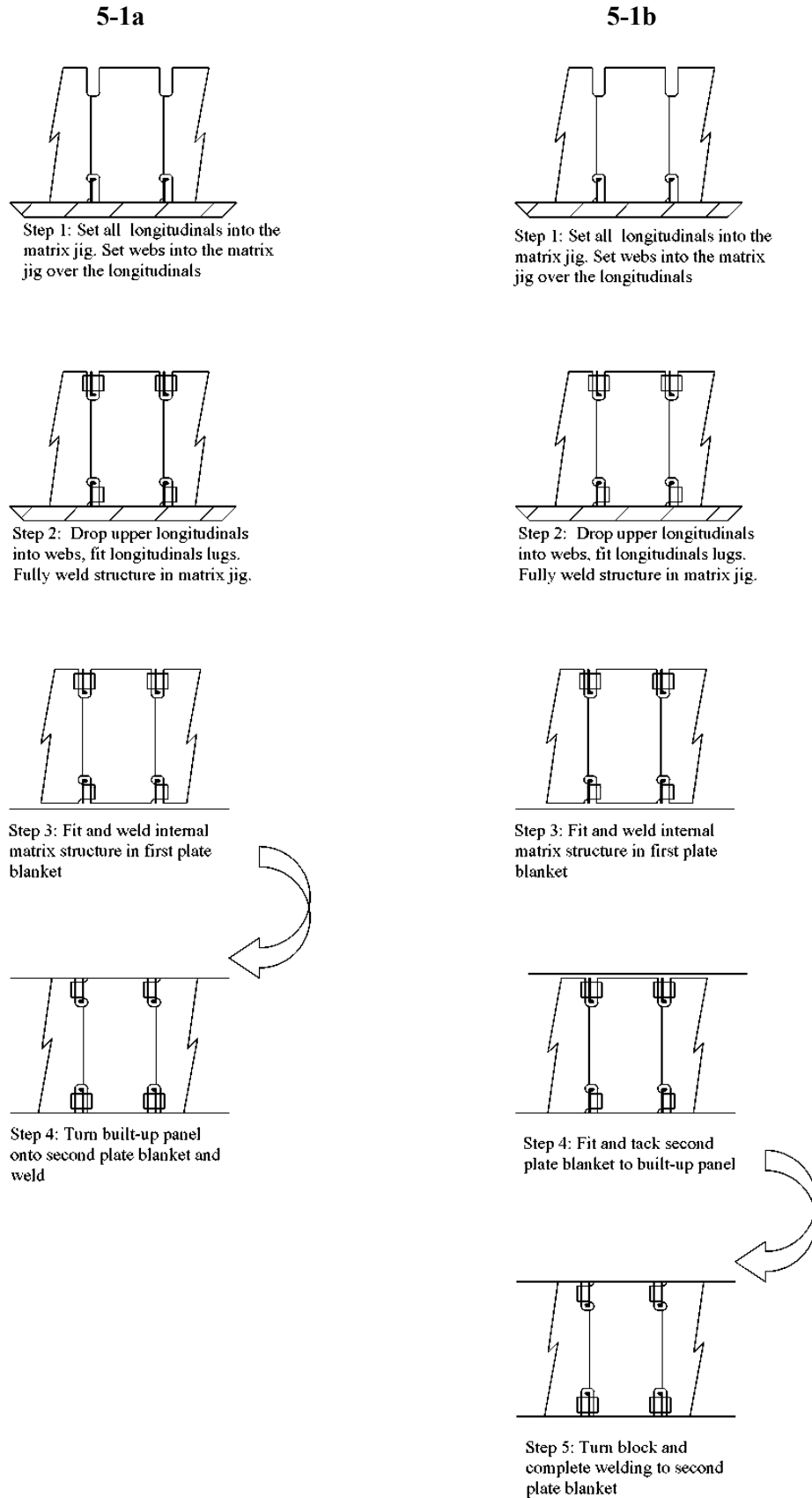
No.	Engineering Criteria	Method 4-2g	
1	Maximize downhand and automatic welding	Overhead welding of longitudinals into web slots. Overhead tacking of 2 <sup>nd</sup> plate blanket to 1 <sup>st</sup> built up panel.	
	Criteria assessment	Simplification 0	Standardization 0
2	Easy access to joints during assembly	Staging required to weld upper longitudinals into slots in the webs. Staging required to tack 2 <sup>nd</sup> plate blanket to 1 <sup>st</sup> built up panel.	
	Criteria assessment	Simplification 0	Standardization 0
3	Self supporting interim products	No	
	Criteria assessment	Simplification 0	Standardization 0
4	Minimize turning during assembly	One turn of 2 <sup>nd</sup> plate blanket onto 1 <sup>st</sup> built up panel. One turn of full block to weld 2 <sup>nd</sup> plate blanket.	
	Criteria assessment	Simplification 0	Standardization 0
5	Simplify connections. Minimize variety.	Fitted slots for longitudinals 1 <sup>st</sup> and 2 <sup>nd</sup> panels.	
	Criteria assessment	Simplification 1	Standardization 1
6	Maximize downhand fitting	Overhead fitting of longitudinal through slots in webs.	
	Criteria assessment	Simplification 0	Standardization 1
7	Minimize joint length. Reduce no. of parts.	For a typical longitudinal bulb flat HP 340*14 on the parallel mid-body. Upper and lower slots: 1000 mm weld length.	
	Criteria assessment	Simplification 1	Standardization 1
8	Self aligning interim products. Reduce need for high accuracy levels.	High level of accuracy required to slide longitudinals through webs top and bottom.	
	Criteria assessment	Simplification 0	Standardization 0
9	Maximize the use of automated assembly lines	Does not use automatic twin fillet welding of longitudinals on panels.	
	Criteria assessment	Simplification 0	Standardization 0
10	Maximize current facilities. Applicable to current technology level.	Requires significant accuracy control development. Requires specialized upper and lower longitudinal pushing equipment.	
	Criteria assessment	Simplification 0	Standardization 0
11	Classification approval.	Requires design and approval of longitudinal slots.	
	Criteria assessment	Simplification 0	Standardization 0
<b>Total</b>		<b>2</b>	<b>3</b>

**Assembly options for principal block assembly method 5-1**

Figure 3.40 shows the principal block assembly method 5-1 adapted for bulb plate longitudinals, while figures 3.41 to 3.44 illustrate the seven options. The complementary option evaluation tables 3.43 to 3.49 are included as well.



**Fig. 3.40. Principal block assembly method 5-1** [2], [30]



**Fig. 3.41. Block assembly methods 5-1a and 5-2b [2], [30]**

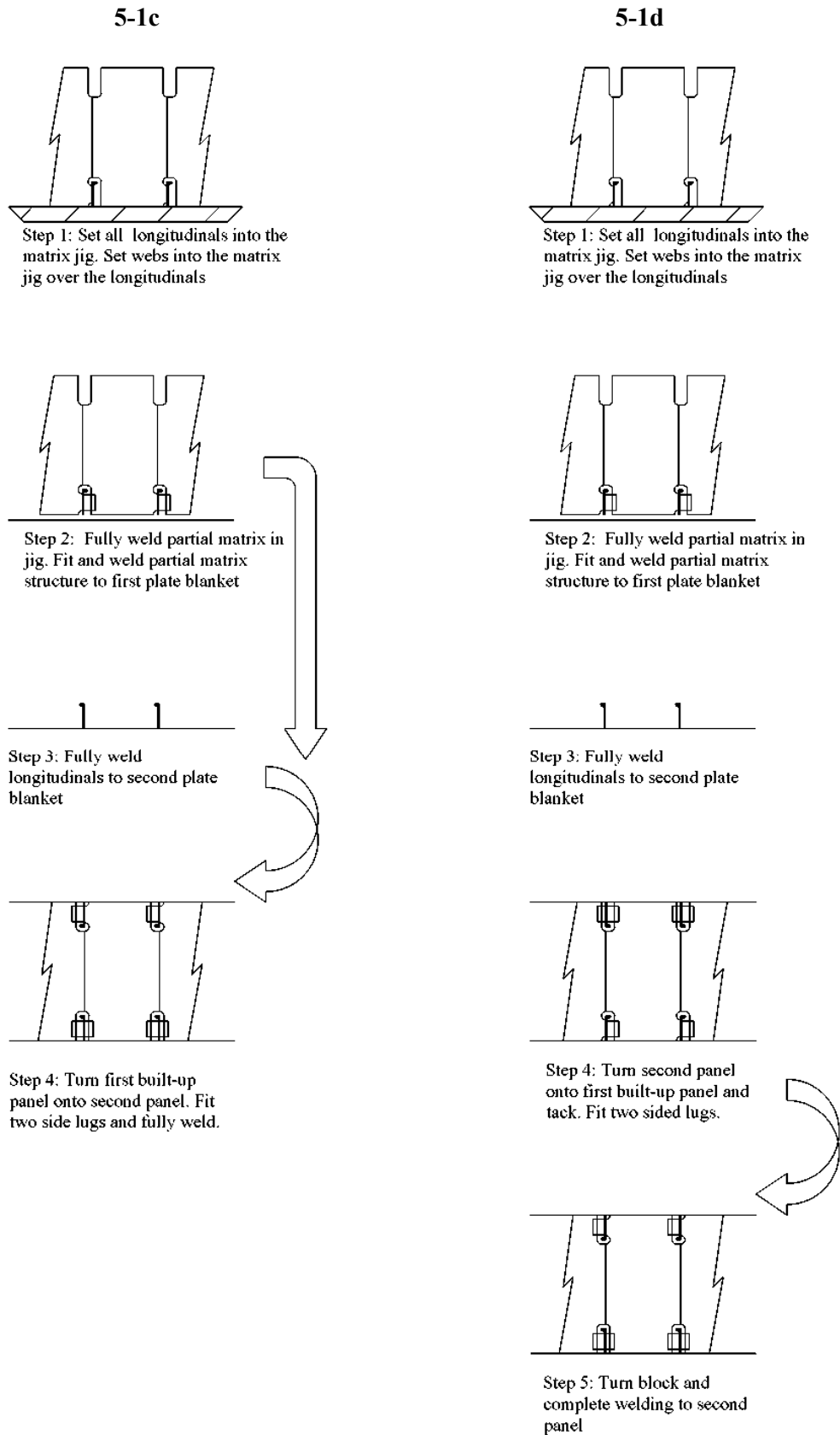


Fig. 3.42. Block assembly methods 5-1c and 5-1d [2], [30]

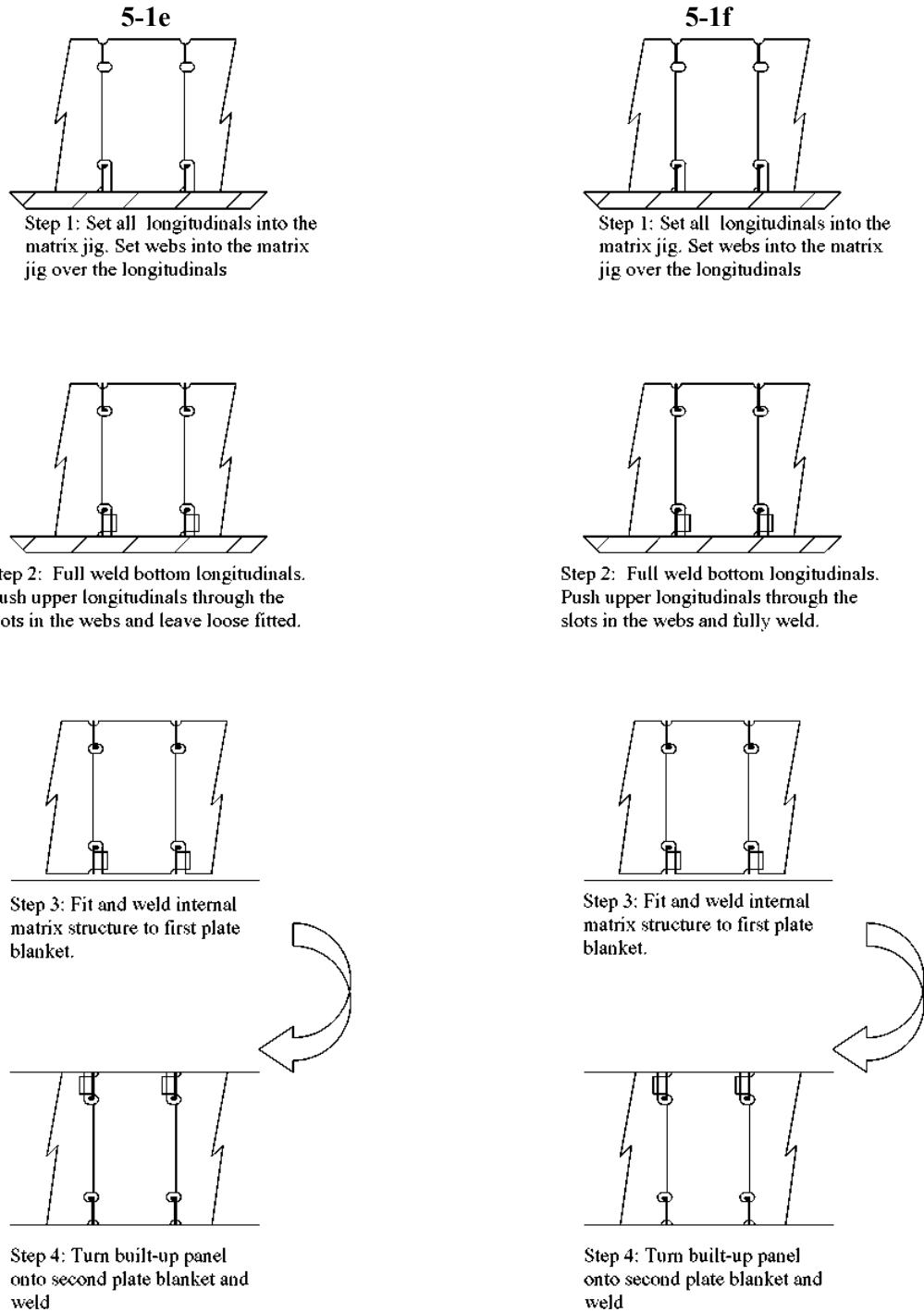
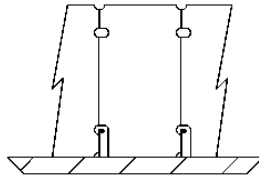
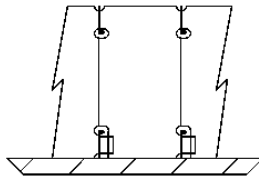


Fig. 3.43. Block assembly methods 5-1e and 5-1f [2], [30]

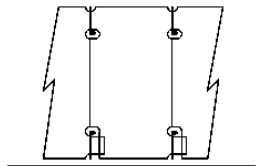


**5-1g**

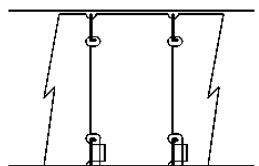
Step 1: Set all longitudinals into the matrix jig. Set webs into the matrix jig over the longitudinals



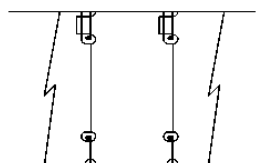
Step 2: Full weld bottom longitudinals. Push upper longitudinals through the slots in the webs and fully weld.



Step 3: Fit and weld internal matrix structure to first plate blanket.



Step 4: Fit and tack second plate blanket to built-up panel



Step 5: Turn block and complete welding to second plate blanket

**Fig. 3.44. Block assembly method 5-1g [2], [30]**

**Tab. 3.43. Assembly option evaluation for block assembly method 5-1a [2], [30]**

No.	Engineering Criteria	Method 5-1a	
1	Maximize downhand and automatic welding	Overhead welding of longitudinals and lugs at webs.	
	Criteria assessment	Simplification 0	Standardization 0
2	Easy access to joints during assembly	Staging required at each web to fit longitudinals and lugs.	
	Criteria assessment	Simplification 0	Standardization 0
3	Self supporting interim products	No	
	Criteria assessment	Simplification 0	Standardization 0
4	Minimize turning during assembly	One assembly turn of built up panel onto second plate blanket.	
	Criteria assessment	Simplification 1	Standardization 1
5	Simplify connections. Minimize variety.	Cut outs with lugs top and bottom.	
	Criteria assessment	Simplification 1	Standardization 1
6	Maximize downhand fitting	Overhead fitting of upper longitudinal and lugs into web cut outs.	
	Criteria assessment	Simplification 0	Standardization 0
7	Minimize joint length. Reduce no. of parts.	For a typical longitudinal bulb flat HP 340*14 on the parallel mid-body. One-sided lug: 950mm weld length; Double sided lug: 1400 mm weld length.	
	Criteria assessment	Simplification 1	Standardization 1
8	Self aligning interim products. Reduce need for high accuracy levels.	Matrix jig simplifies assembly fit-up. Minimum accuracy needed for fitting of webs and longitudinals.	
	Criteria assessment	Simplification 1	Standardization 1
9	Maximize the use of automated assembly lines	Does not use automatic twin fillet welding of longitudinals on panels.	
	Criteria assessment	Simplification 0	Standardization 0
10	Maximize current facilities. Applicable to current technology level.	Requires development of specialized matrix jig. Requires longitudinal fitting equipment for upper longitudinals.	
	Criteria assessment	Simplification 0	Standardization 0
11	Classification approval.	Within current technology level, all details approved.	
	Criteria assessment	Simplification 1	Standardization 1
<b>Total</b>		<b>4</b>	<b>5</b>

**Tab. 3.44. Assembly option evaluation for block assembly method 5-1b [2], [30]**

No.	Engineering Criteria	Method 5-1b	
1	Maximize downhand and automatic welding	Overhead welding of upper longitudinals to webs. Overhead tacking of plate blanket to built up panel.	
	Criteria assessment	Simplification 0	Standardization 0
2	Easy access to joints during assembly	Staging required at each web to fit longitudinals and lugs. Staging required to tack plate blanket to built up panel.	
	Criteria assessment	Simplification 0	Standardization 0
3	Self supporting interim products	No	
	Criteria assessment	Simplification 0	Standardization 0
4	Minimize turning during assembly	One turn of 2 <sup>nd</sup> plate blanket onto 1 <sup>st</sup> built up panel. One turn of full block to weld 2 <sup>nd</sup> plate blanket.	
	Criteria assessment	Simplification 0	Standardization 0
5	Simplify connections. Minimize variety.	Cut outs with lugs top and bottom.	
	Criteria assessment	Simplification 1	Standardization 1
6	Maximize downhand fitting	Overhead fitting of upper longitudinal and lugs into web cut outs.	
	Criteria assessment	Simplification 0	Standardization 0
7	Minimize joint length. Reduce no. of parts.	For a typical longitudinal bulb flat HP 340*14 on the parallel mid-body. One-sided lug: 950mm weld length; Double sided lug: 1400 mm weld length.	
	Criteria assessment	Simplification 0	Standardization 1
8	Self aligning interim products. Reduce need for high accuracy levels.	Matrix jig simplifies assembly fit-up. Minimum accuracy needed for fitting of webs and longitudinals.	
	Criteria assessment	Simplification 1	Standardization 1
9	Maximize the use of automated assembly lines	Does not use automatic twin fillet welding of longitudinals on panels.	
	Criteria assessment	Simplification 0	Standardization 0
10	Maximize current facilities. Applicable to current technology level.	Requires development of specialized matrix jig. Requires longitudinal fitting equipment for upper longitudinals.	
	Criteria assessment	Simplification 0	Standardization 0
11	Classification approval.	Within current technology level, all details approved.	
	Criteria assessment	Simplification 1	Standardization 1
<b>Total</b>		<b>3</b>	<b>4</b>

**Tab 3.45. Assembly option evaluation for block assembly method 5-1c [2], [30]**

No.	Engineering Criteria	Method 5-1c	
1	Maximize downhand and automatic welding	No overhead welding.	
	Criteria assessment	Simplification 1	Standardization 1
2	Easy access to joints during assembly	Simplified access to assembly points.	
	Criteria assessment	Simplification 1	Standardization 1
3	Self supporting interim products	Yes	
	Criteria assessment	Simplification 1	Standardization 1
4	Minimize turning during assembly	One assembly turn of 1 <sup>st</sup> built up panel onto 2 <sup>nd</sup> plate panel.	
	Criteria assessment	Simplification 1	Standardization 1
5	Simplify connections. Minimize variety.	Cut outs with lugs top and bottom.	
	Criteria assessment	Simplification 1	Standardization 1
6	Maximize downhand fitting	All downhand fitting.	
	Criteria assessment	Simplification 1	Standardization 1
7	Minimize joint length. Reduce no. of parts.	For a typical longitudinal bulb flat HP 340*14 on the parallel mid-body. One-sided lug: 950mm weld length; Double sided lug: 1400 mm weld length.	
	Criteria assessment	Simplification 0	Standardization 1
8	Self aligning interim products. Reduce need for high accuracy levels.	Matrix jig simplifies assembly fit-up. Minimum accuracy needed for fitting of webs and longitudinals.	
	Criteria assessment	Simplification 1	Standardization 1
9	Maximize the use of automated assembly lines	Uses automatic twin fillet welding of longitudinals on 2 <sup>nd</sup> panel only.	
	Criteria assessment	Simplification 0	Standardization 0
10	Maximize current facilities. Applicable to current technology level.	Requires development of specialized matrix jig. Requires longitudinal fitting equipment for upper longitudinals.	
	Criteria assessment	Simplification 0	Standardization 0
11	Classification approval.	Within current technology level, all details approved.	
	Criteria assessment	Simplification 1	Standardization 1
<b>Total</b>		<b>8</b>	<b>9</b>

**Tab. 3.46. Assembly option evaluation for block assembly method 5-1d [2], [30]**

No.	Engineering Criteria	Method 5-1d	
1	Maximize downhand and automatic welding	Overhead tacking of 2 <sup>nd</sup> plate panel to 1 <sup>st</sup> built up panel.	
	Criteria assessment	Simplification 0	Standardization 0
2	Easy access to joints during assembly	Staging required at webs to tack 2 <sup>nd</sup> panel to 1 <sup>st</sup> built up panel.	
	Criteria assessment	Simplification 0	Standardization 0
3	Self supporting interim products	Yes	
	Criteria assessment	Simplification 0	Standardization 1
4	Minimize turning during assembly	One turn of 2 <sup>nd</sup> plate panel onto 1 <sup>st</sup> built up panel. One turn of full block to weld 2 <sup>nd</sup> plate panel.	
	Criteria assessment	Simplification 0	Standardization 0
5	Simplify connections. Minimize variety.	Cut outs with lugs top and bottom.	
	Criteria assessment	Simplification 1	Standardization 1
6	Maximize downhand fitting	Overhead fitting of 2 <sup>nd</sup> plate blanket and longitudinal lugs to 1 <sup>st</sup> built up panel.	
	Criteria assessment	Simplification 0	Standardization 0
7	Minimize joint length. Reduce no. of parts.	For a typical longitudinal bulb flat HP 340*14 on the parallel mid-body. One-sided lug: 950mm weld length; Double sided lug: 1400 mm weld length.	
	Criteria assessment	Simplification 0	Standardization 1
8	Self aligning interim products. Reduce need for high accuracy levels.	Matrix jig simplifies assembly fit-up. Minimum accuracy needed for fitting of webs and longitudinals.	
	Criteria assessment	Simplification 1	Standardization 1
9	Maximize the use of automated assembly lines	Uses automatic twin fillet welding of longitudinals on 2 <sup>nd</sup> panel only.	
	Criteria assessment	Simplification 0	Standardization 0
10	Maximize current facilities. Applicable to current technology level.	Requires development of specialized matrix jig.	
	Criteria assessment	Simplification 0	Standardization 0
11	Classification approval.	Within current technology level, all details approved.	
	Criteria assessment	Simplification 1	Standardization 1
<b>Total</b>		<b>3</b>	<b>5</b>

**Tab. 3.47. Assembly option evaluation for block assembly method 5-1e [2], [30]**

No.	Engineering Criteria	Method 5-1e	
1	Maximize downhand and automatic welding	No overhead welding.	
	Criteria assessment	Simplification 1	Standardization 1
2	Easy access to joints during assembly	Staging required to access upper longitudinals during sliding through webs.	
	Criteria assessment	Simplification 0	Standardization 0
3	Self supporting interim products	No	
	Criteria assessment	Simplification 0	Standardization 0
4	Minimize turning during assembly	One assembly turn of 1 <sup>st</sup> built up panel onto 2 <sup>nd</sup> plate blanket.	
	Criteria assessment	Simplification 1	Standardization 1
5	Simplify connections. Minimize variety.	Cut outs with lugs top and bottom. Fitted slots at the bottom.	
	Criteria assessment	Simplification 0	Standardization 0
6	Maximize downhand fitting	All downhand fitting.	
	Criteria assessment	Simplification 1	Standardization 1
7	Minimize joint length. Reduce no. of parts.	For a typical longitudinal bulb flat HP 340*14 on the parallel mid-body. One-sided lug: 950mm weld length; Slot: 500 mm weld length.	
	Criteria assessment	Simplification 1	Standardization 0
8	Self aligning interim products. Reduce need for high accuracy levels.	Matrix jig simplifies assembly fit-up of lower longitudinals. High accuracy required for sliding upper longitudinals through webs.	
	Criteria assessment	Simplification 1	Standardization 0
9	Maximize the use of automated assembly lines	Does not use automatic twin fillet welding of longitudinals on panels.	
	Criteria assessment	Simplification 0	Standardization 0
10	Maximize current facilities. Applicable to current technology level.	Requires development of specialized matrix jig. Requires longitudinal pushing equipment for upper longitudinals.	
	Criteria assessment	Simplification 0	Standardization 0
11	Classification approval.	Requires design and approval of longitudinal slots.	
	Criteria assessment	Simplification 0	Standardization 0
<b>Total</b>		<b>5</b>	<b>3</b>

**Tab. 3.48. Assembly option evaluation for block assembly method 5-1f [2], [30]**

No.	Engineering Criteria	Method 5-1f	
1	Maximize downhand and automatic welding	Overhead welding of longitudinals into cut-outs.	
	Criteria assessment	Simplification 0	Standardization 0
2	Easy access to joints during assembly	Staging required to weld upper longitudinals into slots in the webs.	
	Criteria assessment	Simplification 0	Standardization 0
3	Self supporting interim products	No	
	Criteria assessment	Simplification 0	Standardization 0
4	Minimize turning during assembly	One assembly turn of 1 <sup>st</sup> built up panel onto 2 <sup>nd</sup> plate blanket.	
	Criteria assessment	Simplification 1	Standardization 1
5	Simplify connections. Minimize variety.	Cut outs with lugs top and bottom. Fitted slots at the bottom.	
	Criteria assessment	Simplification 0	Standardization 0
6	Maximize downhand fitting	Overhead fitting of longitudinals in slots in webs.	
	Criteria assessment	Simplification 0	Standardization 0
7	Minimize joint length. Reduce no. of parts.	For a typical longitudinal bulb flat HP 340*14 on the parallel mid-body. One-sided lug: 950mm weld length; Slot: 500 mm weld length.	
	Criteria assessment	Simplification 1	Standardization 0
8	Self aligning interim products. Reduce need for high accuracy levels.	Matrix jig simplifies assembly fit-up of lower longitudinals. High accuracy required for sliding upper longitudinals through webs.	
	Criteria assessment	Simplification 1	Standardization 0
9	Maximize the use of automated assembly lines	Does not use automatic twin fillet welding of longitudinals on panels.	
	Criteria assessment	Simplification 0	Standardization 0
10	Maximize current facilities. Applicable to current technology level.	Requires development of specialized matrix jig. Requires longitudinal pushing equipment for upper longitudinals.	
	Criteria assessment	Simplification 0	Standardization 0
11	Classification approval.	Requires design and approval of longitudinal slots.	
	Criteria assessment	Simplification 0	Standardization 0
<b>Total</b>		<b>3</b>	<b>1</b>

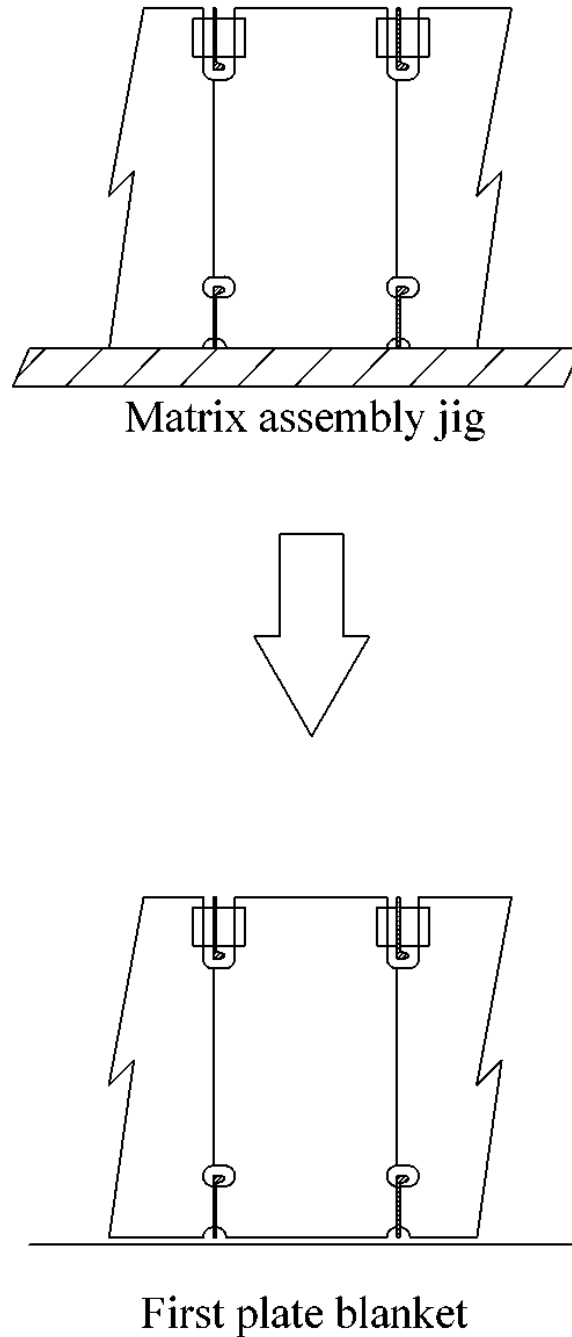
**Tab. 3.49. Assembly option evaluation for block assembly method 5-1g [2], [30]**

No.	Engineering Criteria	Method 5-1g	
1	Maximize downhand and automatic welding	Overhead welding of longitudinals into cut-outs. Overhead tacking of 2 <sup>nd</sup> plate blanket to 1 <sup>st</sup> built up panel.	
	Criteria assessment	Simplification 0	Standardization 0
2	Easy access to joints during assembly	Staging required to weld upper longitudinals into slots in the webs. Staging required to tack 2 <sup>nd</sup> plate blanket to 1 <sup>st</sup> built up panel.	
	Criteria assessment	Simplification 0	Standardization 0
3	Self supporting interim products	No	
	Criteria assessment	Simplification 0	Standardization 0
4	Minimize turning during assembly	One turn of 2nd plate blanket onto 1 <sup>st</sup> built up panel. One turn of full block to weld 2 <sup>nd</sup> plate blanket.	
	Criteria assessment	Simplification 0	Standardization 0
5	Simplify connections. Minimize variety.	Cut outs with lugs at the bottom. Fitted slots at the bottom.	
	Criteria assessment	Simplification 0	Standardization 0
6	Maximize downhand fitting	Overhead fitting of longitudinals in slots in webs. Overhead fitting of 2 <sup>nd</sup> plate blanket to 1 <sup>st</sup> built up panel.	
	Criteria assessment	Simplification 0	Standardization 0
7	Minimize joint length. Reduce no. of parts.	For a typical longitudinal bulb flat HP 340*14 on the parallel mid-body. One-sided lug: 950mm weld length; Slot: 500 mm weld length.	
	Criteria assessment	Simplification 1	Standardization 0
8	Self aligning interim products. Reduce need for high accuracy levels.	Matrix jig simplifies assembly fit-up of lower longitudinals. High accuracy required for sliding upper longitudinals through webs.	
	Criteria assessment	Simplification 1	Standardization 0
9	Maximize the use of automated assembly lines	Does not use automatic twin fillet welding of longitudinals on panels.	
	Criteria assessment	Simplification 0	Standardization 0
10	Maximize current facilities. Applicable to current technology level.	Requires development of specialized matrix jig. Requires longitudinal pushing equipment for upper longitudinals.	
	Criteria assessment	Simplification 0	Standardization 0
11	Classification approval.	Requires design and approval of longitudinal slots.	
	Criteria assessment	Simplification 0	Standardization 0
<b>Total</b>		<b>2</b>	<b>0</b>



**Assembly options for principal block assembly method 5-2**

Figure 3.45 shows the principal block assembly method 5-2 adapted for bulb plate longitudinals, while figures 3.46 to 3.49 illustrate the seven options. The complementary option evaluation tables 3.50 to 3.56 are included as well.



**Fig. 3.45. Principal block assembly method 5-2 [2], [30]**

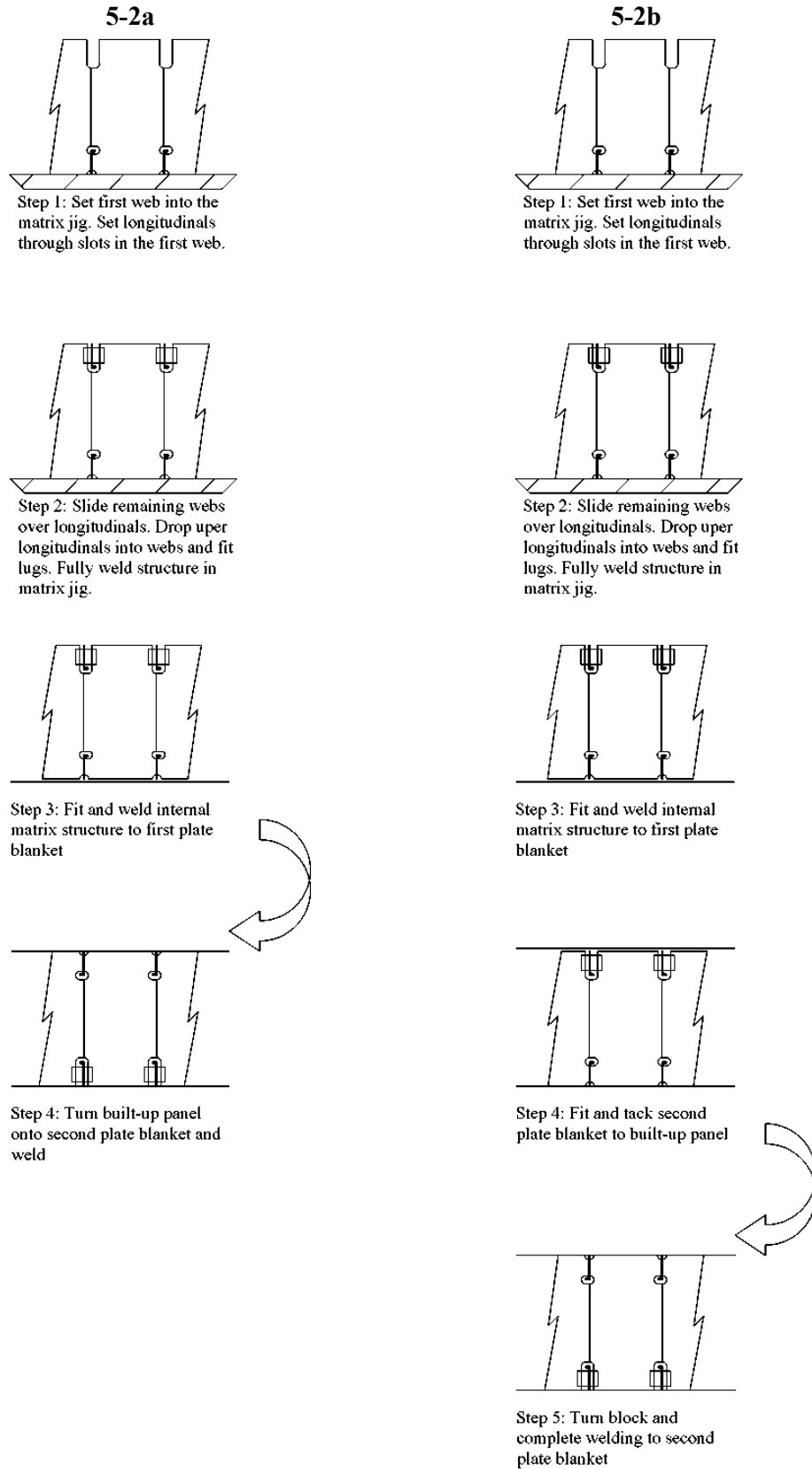


Fig. 3.46. Block assembly methods 5-2a and 5-2b [2], [30]

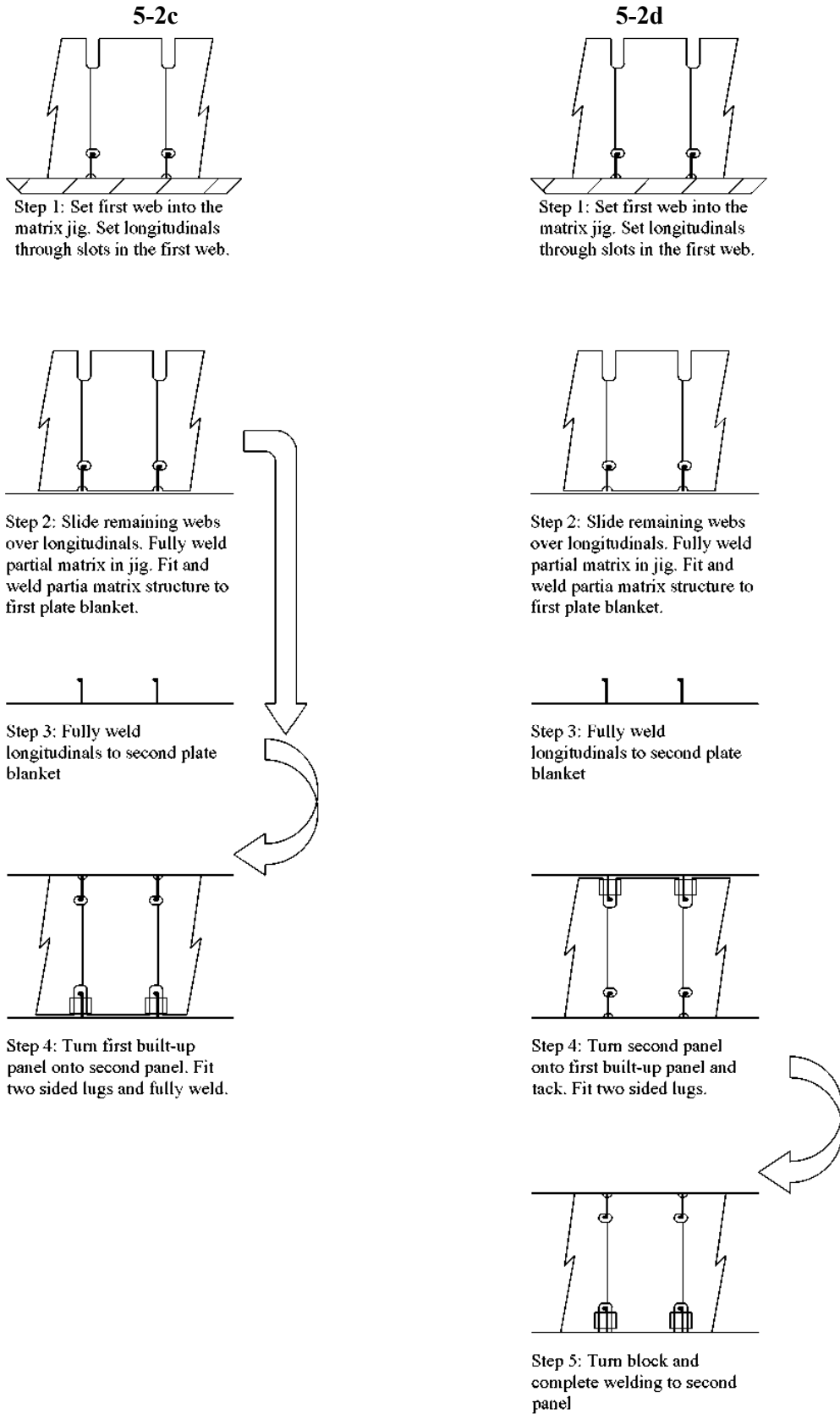
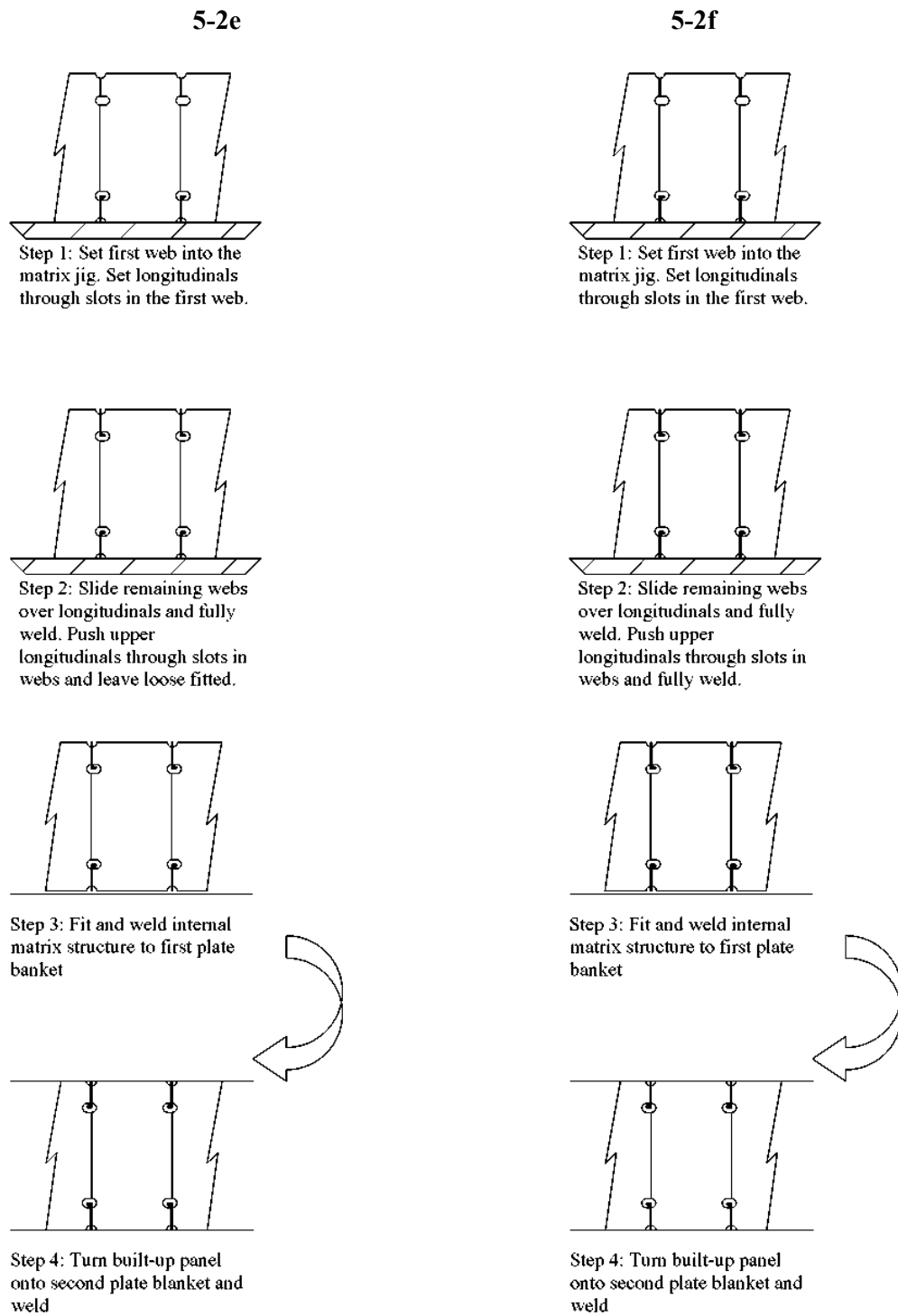
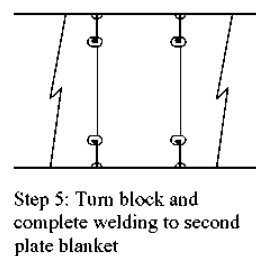
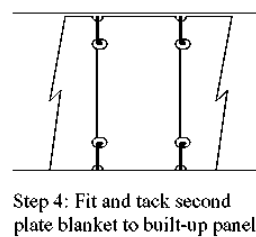
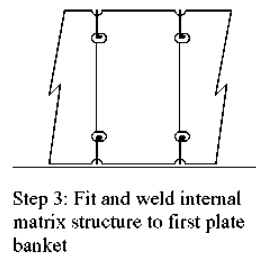
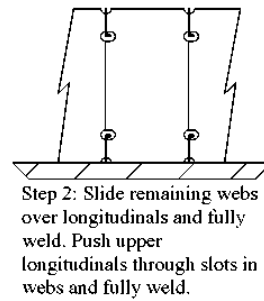
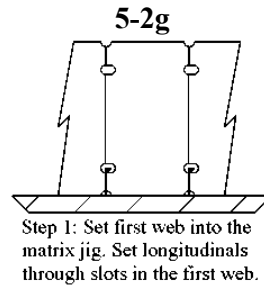


Fig. 3.47. Block assembly methods 5-2c and 5-2d [2], [30]



**Fig. 3.48. Block assembly methods 5-2e and 5-2f [2], [30]**



**Fig. 3.49. Block assembly method 5-2g [2], [30]**

**Tab. 3.50. Assembly option evaluation for block assembly method 5-2a [2], [30]**

No.	Engineering Criteria	Method 5-2a	
1	Maximize downhand and automatic welding	Overhead welding of longitudinals and lugs to webs.	
	Criteria assessment	Simplification 0	Standardization 0
2	Easy access to joints during assembly	Staging required at each web to fit longitudinals and lugs.	
	Criteria assessment	Simplification 0	Standardization 0
3	Self supporting interim products	No	
	Criteria assessment	Simplification 0	Standardization 0
4	Minimize turning during assembly	One assembly turn of 1 <sup>st</sup> built up panel onto 2 <sup>nd</sup> plate blanket.	
	Criteria assessment	Simplification 1	Standardization 1
5	Simplify connections. Minimize variety.	Fitted slots for longitudinals on at bottom of the matrix. Cut outs with lugs both sides at top of matrix.	
	Criteria assessment	Simplification 0	Standardization 0
6	Maximize downhand fitting	Overhead fitting of upper longitudinals and lugs into web cut outs.	
	Criteria assessment	Simplification 0	Standardization 0
7	Minimize joint length. Reduce no. of parts.	For a typical longitudinal bulb flat HP 340*14 on the parallel mid-body. Double-sided lug: 1400mm weld length; Slot: 500 mm weld length.	
	Criteria assessment	Simplification 1	Standardization 0
8	Self aligning interim products. Reduce need for high accuracy levels.	High level of accuracy required to slide webs over longitudinals. No self alignment with open cut-outs at top of webs.	
	Criteria assessment	Simplification 1	Standardization 0
9	Maximize the use of automated assembly lines	Does not use automatic twin fillet welding of longitudinals on panels.	
	Criteria assessment	Simplification 0	Standardization 0
10	Maximize current facilities. Applicable to current technology level.	Requires development of specialized matrix jig. Requires longitudinal fitting equipment for upper longitudinals.	
	Criteria assessment	Simplification 0	Standardization 0
11	Classification approval.	Requires design and approval of longitudinal slots.	
	Criteria assessment	Simplification 0	Standardization 0
<b>Total</b>		<b>2</b>	<b>1</b>

**Tab. 3.51. Assembly option evaluation for block assembly method 5-2b [2], [30]**

No.	Engineering Criteria	Method 5-2b	
1	Maximize downhand and automatic welding	Overhead welding of upper longitudinals to webs. Overhead tacking of plate blanket to built up panel.	
	Criteria assessment	Simplification 0	Standardization 0
2	Easy access to joints during assembly	Staging required at each web to fit longitudinals and lugs. Staging required to tack plate blanket to built up panel.	
	Criteria assessment	Simplification 0	Standardization 0
3	Self supporting interim products	No	
	Criteria assessment	Simplification 0	Standardization 0
4	Minimize turning during assembly	One turn of 2nd plate blanket onto 1 <sup>st</sup> built up panel. One turn of full block to weld 2 <sup>nd</sup> plate blanket	
	Criteria assessment	Simplification 0	Standardization 0
5	Simplify connections. Minimize variety.	Fitted slots for longitudinals on at bottom of the matrix. Cut outs with lugs both sides at top of matrix.	
	Criteria assessment	Simplification 0	Standardization 0
6	Maximize downhand fitting	Overhead fitting of upper longitudinals and lugs into web cut outs. Overhead fitting of 2 <sup>nd</sup> plate blanket to 1 <sup>st</sup> built up panel.	
	Criteria assessment	Simplification 0	Standardization 0
7	Minimize joint length. Reduce no. of parts.	For a typical longitudinal bulb flat HP 340*14 on the parallel mid-body. Double-sided lug: 1400mm weld length; Slot: 500 mm weld length.	
	Criteria assessment	Simplification 0	Standardization 0
8	Self aligning interim products. Reduce need for high accuracy levels.	High level of accuracy required to slide webs over longitudinals. No self alignment with open cut-outs at top of webs.	
	Criteria assessment	Simplification 1	Standardization 0
9	Maximize the use of automated assembly lines	Does not use automatic twin fillet welding of longitudinals on panels.	
	Criteria assessment	Simplification 0	Standardization 0
10	Maximize current facilities. Applicable to current technology level.	Requires development of specialized matrix jig. Requires longitudinal fitting equipment for upper longitudinals.	
	Criteria assessment	Simplification 0	Standardization 0
11	Classification approval.	Requires design and approval of longitudinal slots.	
	Criteria assessment	Simplification 0	Standardization 0
<b>Total</b>		<b>1</b>	<b>0</b>

**Tab. 3.52. Assembly option evaluation for block assembly method 5-2c [2], [30]**

No.	Engineering Criteria	Method 5-2c	
1	Maximize downhand and automatic welding	No overhead welding.	
	Criteria assessment	Simplification 1	Standardization 1
2	Easy access to joints during assembly	Simplified access to assembly joints.	
	Criteria assessment	Simplification 1	Standardization 1
3	Self supporting interim products	Yes	
	Criteria assessment	Simplification 1	Standardization 1
4	Minimize turning during assembly	One assembly turn of 1 <sup>st</sup> built up panel onto 2 <sup>nd</sup> plate panel.	
	Criteria assessment	Simplification 1	Standardization 1
5	Simplify connections. Minimize variety.	Fitted slots for longitudinals on bottom of the matrix. Cut outs with lugs both sides at top of matrix.	
	Criteria assessment	Simplification 0	Standardization 0
6	Maximize downhand fitting	All downhand fitting.	
	Criteria assessment	Simplification 1	Standardization 1
7	Minimize joint length. Reduce no. of parts.	For a typical longitudinal bulb flat HP 340*14 on the parallel mid-body. Double-sided lug: 1400mm weld length; Slot: 500 mm weld length.	
	Criteria assessment	Simplification 0	Standardization 0
8	Self aligning interim products. Reduce need for high accuracy levels.	High level of accuracy required to slide webs over longitudinals. No self alignment of built-up panel to 2 <sup>nd</sup> panel.	
	Criteria assessment	Simplification 1	Standardization 0
9	Maximize the use of automated assembly lines	Uses automatic twin fillet welding of longitudinals on 2 <sup>nd</sup> panel only.	
	Criteria assessment	Simplification 0	Standardization 0
10	Maximize current facilities. Applicable to current technology level.	Requires development of specialized matrix jig.	
	Criteria assessment	Simplification 0	Standardization 0
11	Classification approval.	Requires design and approval of longitudinal slots.	
	Criteria assessment	Simplification 0	Standardization 0
<b>Total</b>		<b>6</b>	<b>5</b>



**Tab. 3.53. Assembly option evaluation for block assembly method 5-2d [2], [30]**

No.	Engineering Criteria	Method 5-2d	
1	Maximize downhand and automatic welding	Overhead fitting of 2 <sup>nd</sup> panel to the 1 <sup>st</sup> built up panel.	
	Criteria assessment	Simplification 0	Standardization 0
2	Easy access to joints during assembly	Staging required at webs to tack 2 <sup>nd</sup> panel to 1 <sup>st</sup> built up panel.	
	Criteria assessment	Simplification 0	Standardization 0
3	Self supporting interim products	Yes	
	Criteria assessment	Simplification 0	Standardization 1
4	Minimize turning during assembly	One turn of 2 <sup>nd</sup> plate panel onto 1 <sup>st</sup> built up panel. One turn of full block to weld 2 <sup>nd</sup> plate panel. .	
	Criteria assessment	Simplification 0	Standardization 0
5	Simplify connections. Minimize variety.	Fitted slots for longitudinals on at bottom of the matrix. Cut outs with lugs both sides at top of matrix.	
	Criteria assessment	Simplification 0	Standardization 0
6	Maximize downhand fitting	Overhead fitting of 2 <sup>nd</sup> plate blanket and longitudinal lugs to 1 <sup>st</sup> built up panel.	
	Criteria assessment	Simplification 0	Standardization 0
7	Minimize joint length. Reduce no. of parts.	For a typical longitudinal bulb flat HP 340*14 on the parallel mid-body. Double-sided lug: 1400mm weld length; Slot: 500 mm weld length.	
	Criteria assessment	Simplification 0	Standardization 0
8	Self aligning interim products. Reduce need for high accuracy levels.	High level of accuracy required to slide webs over longitudinals. No self alignment of built-up panel to 2 <sup>nd</sup> panel.	
	Criteria assessment	Simplification 1	Standardization 0
9	Maximize the use of automated assembly lines	Uses automatic twin fillet welding of longitudinals on 2 <sup>nd</sup> panel only.	
	Criteria assessment	Simplification 0	Standardization 0
10	Maximize current facilities. Applicable to current technology level.	Requires development of specialized matrix jig.	
	Criteria assessment	Simplification 0	Standardization 0
11	Classification approval.	Requires design and approval of longitudinal slots.	
	Criteria assessment	Simplification 0	Standardization 0
<b>Total</b>		<b>1</b>	<b>1</b>

**Tab. 3.54. Assembly option evaluation for block assembly method 5-2e [2], [30]**

No.	Engineering Criteria	Method 5-2e	
1	Maximize downhand and automatic welding	No overhead welding.	
	Criteria assessment	Simplification 1	Standardization 1
2	Easy access to joints during assembly	Staging required to access upper longitudinals during sliding through webs.	
	Criteria assessment	Simplification 0	Standardization 0
3	Self supporting interim products	No	
	Criteria assessment	Simplification 0	Standardization 0
4	Minimize turning during assembly	One assembly turn of 1st built up panel onto 2 <sup>nd</sup> plate blanket.	
	Criteria assessment	Simplification 1	Standardization 1
5	Simplify connections. Minimize variety.	Fitted slots for longitudinals at top and bottom of internal matrix.	
	Criteria assessment	Simplification 1	Standardization 1
6	Maximize downhand fitting	Overhead fitting of longitudinal through slots in webs. Lugs to 1 <sup>st</sup> built up panel.	
	Criteria assessment	Simplification 0	Standardization 1
7	Minimize joint length. Reduce no. of parts.	For a typical longitudinal bulb flat HP 340*14 on the parallel mid-body. Slots top and bottom: 1000 mm weld length.	
	Criteria assessment	Simplification 1	Standardization 1
8	Self aligning interim products. Reduce need for high accuracy levels.	Matrix jig simplifies fit-up of lower longitudinals. High accuracy required for sliding webs and slotting upper longitudinals.	
	Criteria assessment	Simplification 1	Standardization 1
9	Maximize the use of automated assembly lines	Does not use automatic twin fillet welding of longitudinals on panels.	
	Criteria assessment	Simplification 0	Standardization 0
10	Maximize current facilities. Applicable to current technology level.	Requires development of specialized matrix jig. Requires longitudinal pushing equipment for upper longitudinals.	
	Criteria assessment	Simplification 0	Standardization 0
11	Classification approval.	Requires design and approval of longitudinal slots.	
	Criteria assessment	Simplification 0	Standardization 0
<b>Total</b>		<b>5</b>	<b>6</b>

**Tab. 3.55. Assembly option evaluation for block assembly method 5-2f [2], [30]**

No.	Engineering Criteria	Method 5-2f	
1	Maximize downhand and automatic welding	Overhead welding of longitudinals onto web slots.	
	Criteria assessment	Simplification 0	Standardization 0
2	Easy access to joints during assembly	Staging required to access upper longitudinals during sliding through webs.	
	Criteria assessment	Simplification 0	Standardization 0
3	Self supporting interim products	No	
	Criteria assessment	Simplification 0	Standardization 0
4	Minimize turning during assembly	One assembly turn of 1st built up panel onto 2 <sup>nd</sup> plate blanket.	
	Criteria assessment	Simplification 1	Standardization 1
5	Simplify connections. Minimize variety.	Fitted slots for longitudinals at top and bottom of internal matrix.	
	Criteria assessment	Simplification 1	Standardization 1
6	Maximize downhand fitting	Overhead fitting of longitudinal through slots in webs.	
	Criteria assessment	Simplification 0	Standardization 1
7	Minimize joint length. Reduce no. of parts.	For a typical longitudinal bulb flat HP 340*14 on the parallel mid-body. Slots top and bottom: 1000 mm weld length.	
	Criteria assessment	Simplification 1	Standardization 1
8	Self aligning interim products. Reduce need for high accuracy levels.	Matrix jig simplifies fit-up of lower longitudinals. High accuracy required for sliding webs and slotting upper longitudinals.	
	Criteria assessment	Simplification 1	Standardization 1
9	Maximize the use of automated assembly lines	Does not use automatic twin fillet welding of longitudinals on panels.	
	Criteria assessment	Simplification 0	Standardization 0
10	Maximize current facilities. Applicable to current technology level.	Requires development of specialized matrix jig. Requires longitudinal pushing equipment for upper longitudinals.	
	Criteria assessment	Simplification 0	Standardization 0
11	Classification approval.	Requires design and approval of longitudinal slots.	
	Criteria assessment	Simplification 0	Standardization 0
<b>Total</b>		<b>4</b>	<b>5</b>

**Tab. 3.56. Assembly option evaluation for block assembly method 5-2g [2], [30]**

No.	Engineering Criteria	Method 5-2g	
1	Maximize downhand and automatic welding	Overhead welding of longitudinals onto web slots. Overhead tacking of 2 <sup>nd</sup> plate blanket to 1 <sup>st</sup> built up panel.	
	Criteria assessment	Simplification 0	Standardization 0
2	Easy access to joints during assembly	Staging required to access upper longitudinals during sliding through webs. Staging required to tack 2 <sup>nd</sup> plate blanket to 1 <sup>st</sup> built up panel.	
	Criteria assessment	Simplification 0	Standardization 0
3	Self supporting interim products	No	
	Criteria assessment	Simplification 0	Standardization 0
4	Minimize turning during assembly	One turn of 2nd plate blanket onto 1 <sup>st</sup> built up panel. One turn of full block to weld 2 <sup>nd</sup> plate blanket.	
	Criteria assessment	Simplification 0	Standardization 0
5	Simplify connections. Minimize variety.	Fitted slots for longitudinals at top and bottom of internal matrix.	
	Criteria assessment	Simplification 1	Standardization 1
6	Maximize downhand fitting	Overhead fitting of longitudinal through slots in webs.	
	Criteria assessment	Simplification 0	Standardization 1
7	Minimize joint length. Reduce no. of parts.	For a typical longitudinal bulb flat HP 340*14 on the parallel mid-body. Slots top and bottom: 1000 mm weld length.	
	Criteria assessment	Simplification 1	Standardization 1
8	Self aligning interim products. Reduce need for high accuracy levels.	Matrix jig simplifies fit-up of lower longitudinals. High accuracy required for sliding webs and slotting upper longitudinals.	
	Criteria assessment	Simplification 1	Standardization 1
9	Maximize the use of automated assembly lines	Does not use automatic twin fillet welding of longitudinals on panels.	
	Criteria assessment	Simplification 0	Standardization 0
10	Maximize current facilities. Applicable to current technology level.	Requires development of specialized matrix jig. Requires longitudinal pushing equipment for upper longitudinals.	
	Criteria assessment	Simplification 0	Standardization 0
11	Classification approval.	Requires design and approval of longitudinal slots.	
	Criteria assessment	Simplification 0	Standardization 0
<b>Total</b>		<b>3</b>	<b>4</b>

### 3.3.1. Summary of block assembly methods evaluation

The 56 block assembly methods of the previous tables 3.1 to 3.56 are summarized in the table below. In this table, the block assembly method ratings for all eleven criteria and both categories of simplification and standardization are summed up. These ratings are applicable for shipyards with the standard and most common panel-block assembly technology level.

**Tab. 3.57. Summary of block assembly method evaluations [2], [30]**

<b>Method</b>	1a	1b	1c	1d	1e	1f	1g
<b>Rating</b>	8	6	21	10	7	3	1
<b>Method</b>	2a	2b	2c	2d	2d	2e	2f
<b>Rating</b>	2	0	12	3	9	7	5
<b>Method</b>	3-1a	3-1b	3-1c	3-1d	3-1e	3-1f	3-1g
<b>Rating</b>	8	6	17	6	7	3	1
<b>Method</b>	3-2a	3-2b	3-2c	3-2d	3-2e	3-2f	3-2g
<b>Rating</b>	2	0	10	1	9	7	5
<b>Method</b>	4-1a	4-1b	4-1c	4-1d	4-1e	4-1f	4-1g
<b>Rating</b>	8	6	17	6	7	3	1
<b>Method</b>	4-2a	4-2b	4-2c	4-2d	4-2e	4-2f	4-2g
<b>Rating</b>	2	0	10	1	9	7	5
<b>Method</b>	5-1a	5-1b	5-1c	5-1d	5-1e	5-1f	5-1g
<b>Rating</b>	9	7	17	8	8	4	2
<b>Method</b>	5-2a	5-2b	5-2c	5-2d	5-2e	5-2f	5-2g
<b>Rating</b>	3	1	11	2	11	9	7

Considering the present state technology level of the block assembly process, block assembly method 1c with a value of 21 is the best block assembly method for the present state technology level. In summary, the longitudinals are fitted and welded to both the base panel and the secondary panel. Then, the base panel is built up with the internal structure (webs and transverses with cut-outs). The built-up base panel is turned onto the secondary panel. Lugs are fitted and welded on both the top and the bottom of the new block [2]. This is the procedure that is used in most shipyards today.

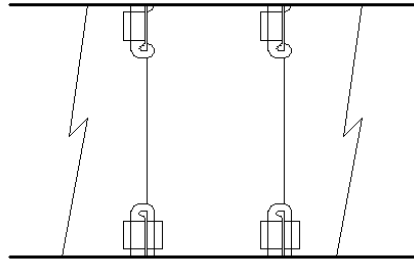
### 3.3.2. Work content analysis

The preceding table analysis is useful in determining the best assembly method that the shipyard should use for its present state technology level. In order to determine the future direction that the shipyard should be moving towards, a work content analysis would be useful [2]. This is in accordance to kaizen which in Japanese means “change for the better” [25]. Even though block assembly method 1c is appropriate for the present technology level of the shipyard, management and production engineers must look towards the future and always try to improve shipbuilding methods and technologies.

The categories of block assembly methods chosen for measuring the work content analysis derives from four block assembly method options. These four categories fairly evenly represent the different types of methods and “design detail used for the longitudinals to penetrate the transverse members and the basic assembly concept (built-up panel or internal egg-box structure)” [2].

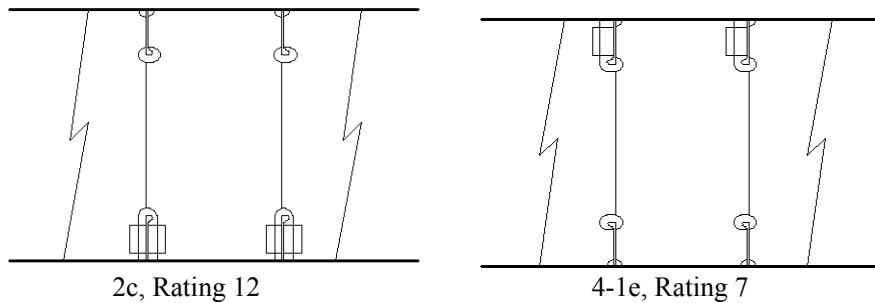
The categories to be used for work content analysis include :

- **Category 1:** “Longitudinals passing through open cut-outs in transverse members” [2]. The upper longitudinals with a lug on one side. The lower longitudinals with lugs on both sides. This category derives from block assembly method 1c, which has a rating of 21 (See Figure 3.12 and Table 3.3) (Figure 3.50).



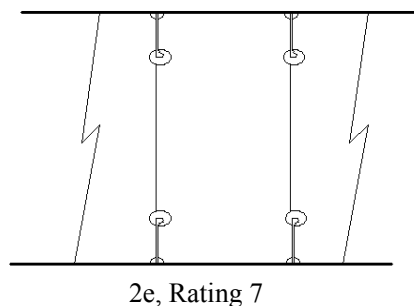
**Fig. 3.50. Block assembly method 1c**

- **Category 2:** “Longitudinals passing through transverse members in a combination of one side fitted cut-outs and fitted slots” [2]. This derives from block assembly method 2c, Figure 3.17, Table 3.10 which has a rating of 12 and block assembly method 4-1e, which has a rating of 7 (See Figure 3.33, Table 3.33) (Figure 3.51).



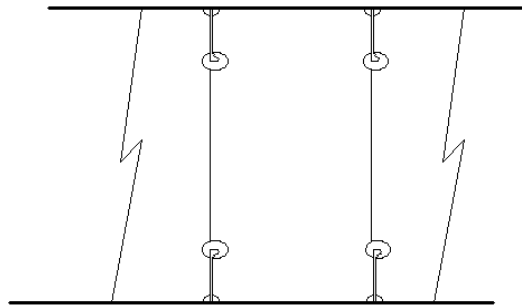
**Fig. 3.51: Block assembly methods 2c and 4-1e**

- **Category 3:** Webs are slid through slots in transverse members on the base panel, and the upper longitudinals are slid through the upper slots in the webs and fitted. Finally, the built-up base panel is turned over onto a corresponding bed plate and welded. This derives from block assembly method 2e which has a rating of 7 (See Figure 3.18, Table 3.12) (Figure 3.52) [2].



**Fig. 3.52. Block assembly method 2e**

- **Category 4:** “Longitudinals passing through fitted slots in transverse elements assembled in a matrix jig off the panels” [2]. This category derives from block assembly method 5-2e, which has a rating of 11 (See Figure 3.48, Table 3.54) (Figure 3.53).



5-2e, Rating 11

**Fig. 3.53. Block assembly method 5e**

For analysis purposes a generic block with the following characteristics defined should be used [2], [30]:

Block type:	Double bottom section
Block size:	Length (m) x Width (m) x Height (m)
No of panels:	4 or 5
No of plates / panel:	4 or 5
No of longitudinals / panel:	10 to 14
No of transverse members / panel:	3-5

**Fig. 3.54. Typical double bottom block [29]**

The following work content parameters can be determined for each of the above categories for the current technology level of the shipyard in terms of [2]:

- “total weld length in meters,
- total man-hours for fitting and welding (including turning during assembly), and
- welding rate in meters / hour”.

The analysis of the categories should show that as we move from Category 1 to Category 4, the total amount of welding lengths decreases due to the changes from cut-outs to slots in the transverse members or webs. At the same time, the corresponding man-hours increase. The reason for this converse relationship is because changing the methodology of assembling from open cut-outs to slots results in necessary technology changes to be made as well. Particularly in the “areas of part cutting, accuracy control and stabilized assembly sequences and

processes” [2]. Since the technology of the shipyard has remained the same or fixed, the man-hours increased instead of decreasing. Properly adjusting the shipyard technology to meet the new methodology of transverses with slots will result in the decrease of man-hours “corresponding to the reduction in weld length” [2].

### 3.4. PURPOSE OF DEVELOPING THE TYPE PLAN

The purpose of developing a type plan for block assembly is in order to eliminate the risk of foremen making production decisions that should be controlled by management. The optimum block assembly method with defined design details (e.g. type of cut-outs and lugs) for the present state technology level can be determined through the manner described above. The definition of the production workstations with their operations and constraints should also be defined [2].

Shipbuilding strategy is defined through type plans for assembling interim products. A PWBS as defined earlier is a foundation upon which type plans can be created and later maintained and even improved upon. The four stages for developing type plans includes: [2]

- “Preparing the basic process engineering and defining the product family,
- Defining the preferred production process lanes and workstations,
- Developing the production process analysis, and
- Defining the design/engineering criteria and content of workstation information”.

The basic process engineering is developed from analysis of the various block assembly methods. “The first step is to summarize the information from the assembly option evaluation exercise and to prepare the general description of the type plan. The general description examines the comments made against each of the production engineering criteria for the assembly method to be adopted. These are summarized into” [2]:

- “Possible risk areas,
- General areas where improvements can be made, and
- A series of suggested performance improvement initiatives to be defined in detail during the production process analysis and recommended improvements”.

### 3.5. TRADITIONAL WORKSTATION ACTIVITIES IN PANEL AND BLOCK ASSEMBLY

The reason that the workstation activities need to be broken down and described separately is in order to analyze how to improve flow and quality according to lean principles [4], [25]. One logical step of improving flow includes reducing the non-added value activities.

- 1) The *key assembly steps* briefly describes the process.
- 2) The product input requirements describes the prerequisites of the interim product prior to its arrival at the workstation. They are important for flow to be continuous.
- 3) The facility constraints and equipment lists what needs to be considered from the technological point of view in terms of the equipment.
- 4) The production methods and processes are necessary to consider specific methods used.
- 5) Design/engineering includes items that the designers should consider during the design of the vessel. For example plate thicknesses, longitudinals used, spacing of webs, etc [2], [28].



All of the above criteria are necessary prerequisites for maintaining flow and quality throughout the manufacturing process as mentioned earlier in this work.

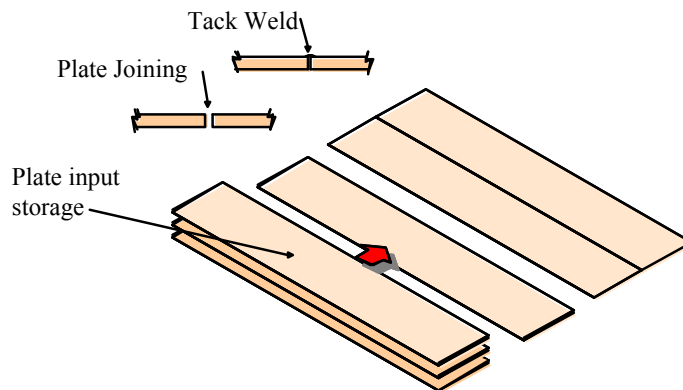
The assembly of a block starts from the panel line and continues with the built up panel line. The two processes are broken down into nine main activities. Depending on the shipyard in question, often one or two activities are performed at a given workstation [2], [30]. In order to differentiate between the activities the input and output of each activity is emphasised below. The following panel-block assembly activities describe each of the nine DFP assembly steps.

### **Activity 1 - Panel Assembly**

**Input:** Steel plates.

**Output:** Plate blanket.

The first plate is loaded onto the workstation. The second plate is loaded and aligned with the first plate. The joints are “faired and tacked”. This procedure is repeated for the corresponding plates to finally form the plate blanket (See Figure 3.55) [2].



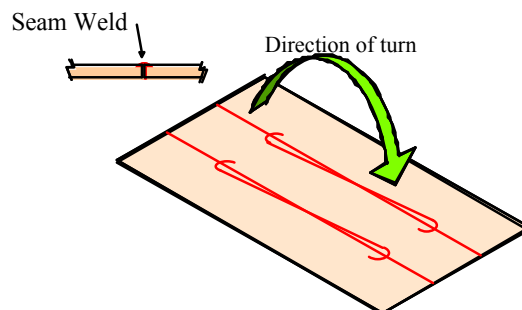
**Fig. 3.55. Bed plate assembly [2]**

### **Activity 2 - Panel Welding**

**Input:** Fitted and tacked bed plate

**Output:** Welded plate blanket

The fitted and tacked plate blanket is then welded along the seams on the first side. Then it is turned over and fully welded along the seams on the second side (See Figure 3.56) [2].



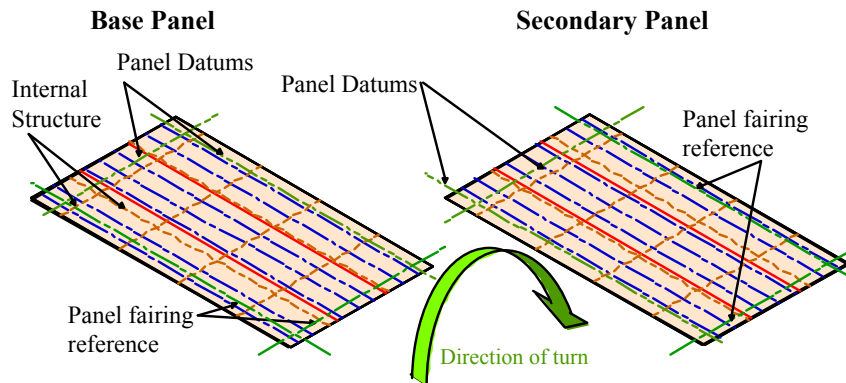
**Fig. 3.56. Panel welding [2]**

### **Activity 3 - Panel Layout**

**Input:** Welded plate blanket

**Output:** Marked plate blanket

The welded plate blanket is marked for longitudinals and structural elements (See Figure 3.57)[2]. Please note that panel datums signify reference data lines.



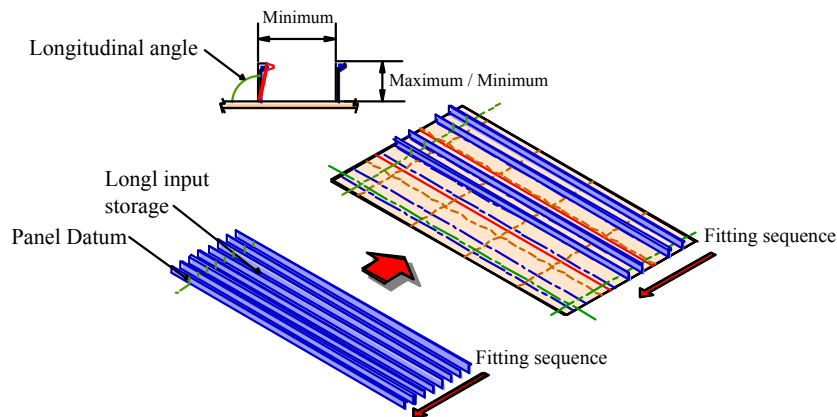
**Fig. 3.57. Panel layout [2]**

#### **Activity 4 - Longitudinal fitting**

**Input:** Marked welded plate blanket and longitudinals.

**Output:** Stiffened plate blanket.

The longitudinals are placed along the previously marked positions of the plate blanket and then tack welded (See Figure 3.58) [2].



**Fig. 3.58. Longitudinal fitting [2]**

#### **Activity 5 - Longitudinal welding**

**Input:** Stiffened plate blanket

**Output:** Flat panel

The longitudinals are then completely welded to the plate blanket. This results in a flat stiffened panel, which is either ready to undergo further interim product assembly or can independently move on towards block assembly (See Figure 3.59) [2].

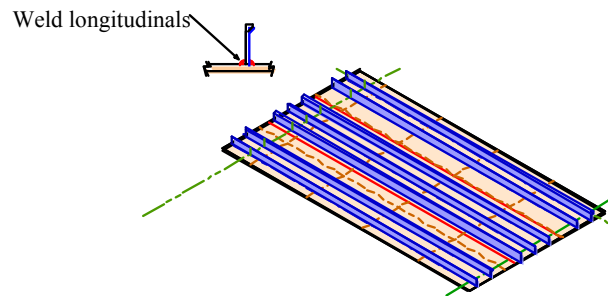


Fig. 3.59. Longitudinal welding [2]

### **Activity 6 - Internal structure fitting**

**Input:** Flat panel and internal structure elements.

**Output:** Flat panel with fitted internal structure.

The internal structure is fitted on the marked locations of the flat panel and then tack welded. (See Figure 3.60) [2].

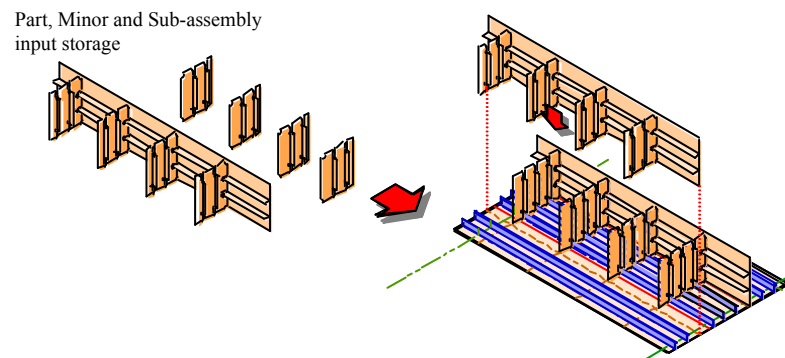


Fig. 3.60. Internal structure fitting [2]

### **Activity 7 - Welding and outfitting of built-up unit**

**Input:** Flat panel with fitted internal structure and outfitting elements.

**Output:** Flat built-up panel.

The fitted internal structure is then completely welded. Likewise, outfitting elements such as pipes are fitted. Welding of the internal structure to the stiffened panel and outfitting as well (See Figure 3.61) [2].

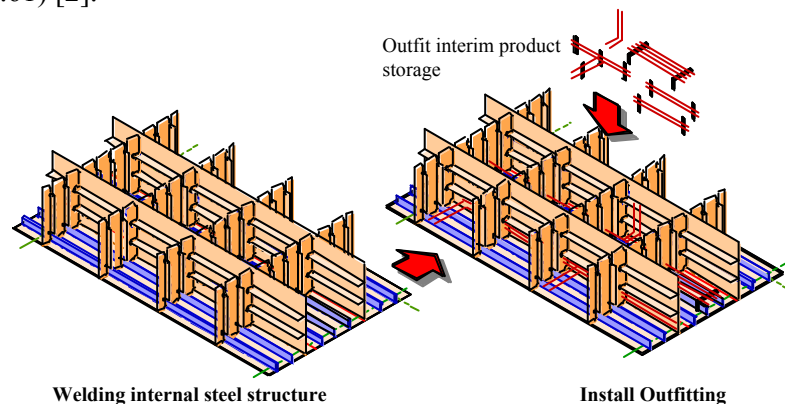
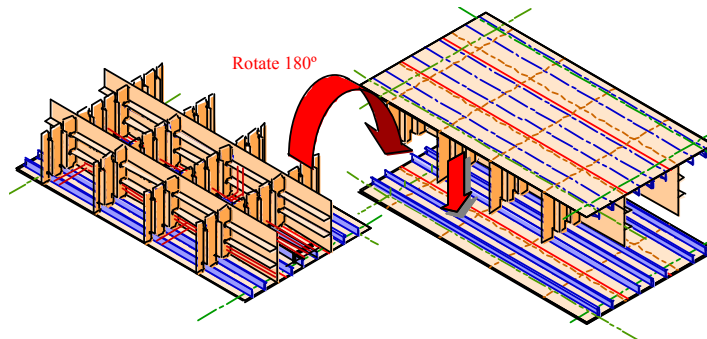


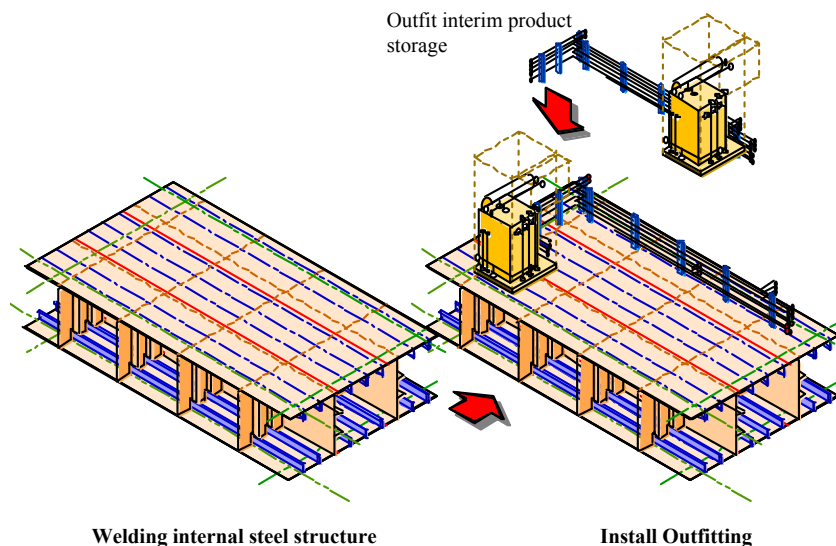
Fig. 3.61. Welding and outfitting of built-up panel [2]

**Activity 8 - Turning and fitting****Input:** Flat built-up panel.**Output:** Turned built-up panel fitted to a secondary panel.

The built-up panel is turned and fitted to a secondary panel (See Figure 3.62) [2].

**Fig. 3.62. Turning and fitting [2]****Activity 9 - Welding and outfitting of block assembly****Input:** Fitted block**Output:** Double skin block

The internal structure is welded to the stiffened panel and the block is outfitted as well. (See Figure 3.63) [2].

**Fig. 3.63. Internal structure welding [2]****3.6. LEAN TRANSFORMATION OF SHIPBUILDING BLOCK ASSEMBLY**

Lean transformation of the traditional method of assembling blocks requires the one piece flow approach with equal takt time at each workstation. Interim products arrive Just in Time (JIT). Likewise a PWBS shipyard organization facilitates the repetitive nature of the interim products produced, which includes unit panels, and transverses, which when assembled together form larger blocks (See Figure 3.64).

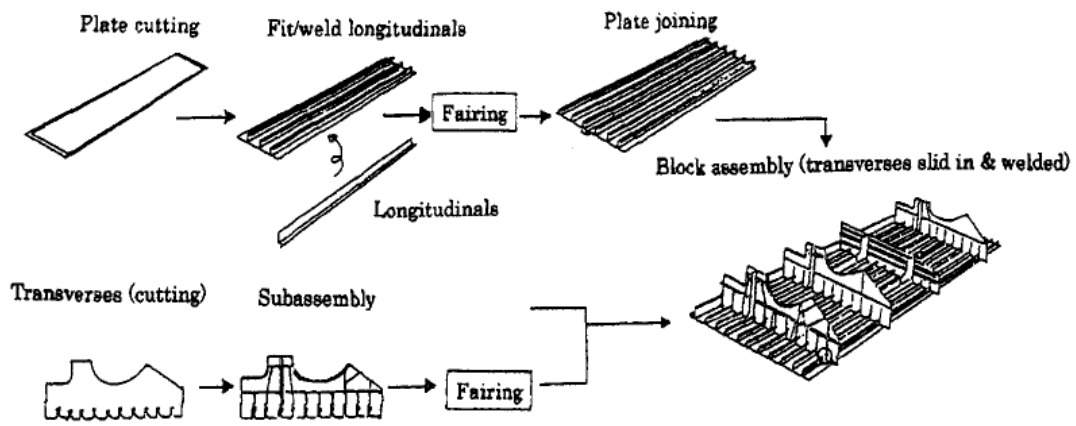


Fig. 3.64. Unit panel and slot construction [4]

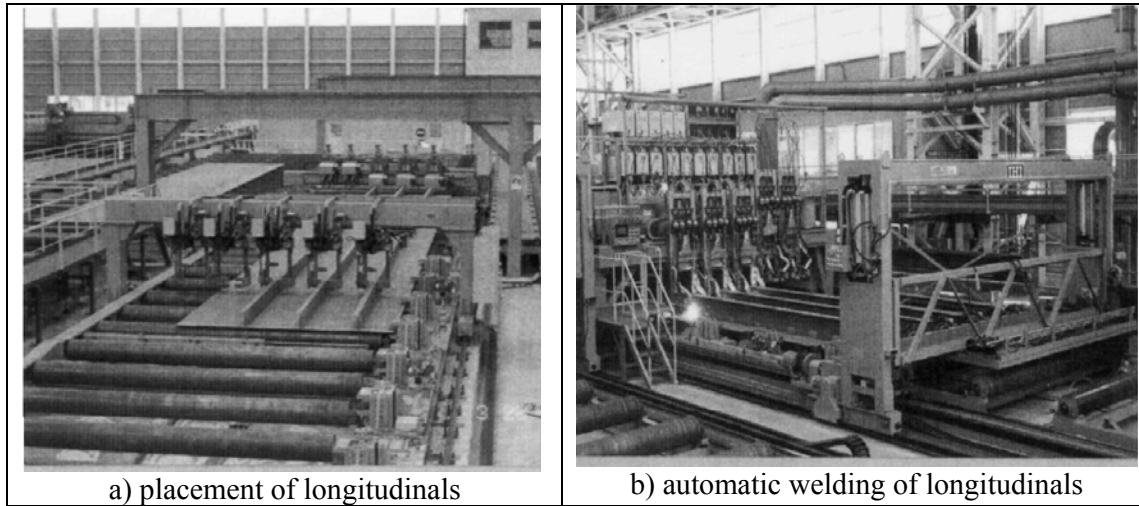


Fig. 3.65. Unit panel and slot construction—automatic placement and welding of longitudinals [4]

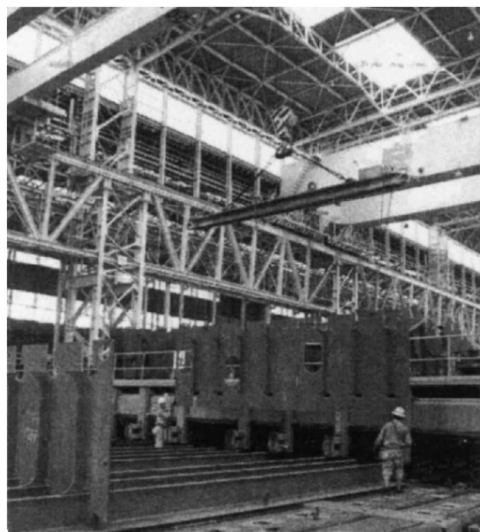
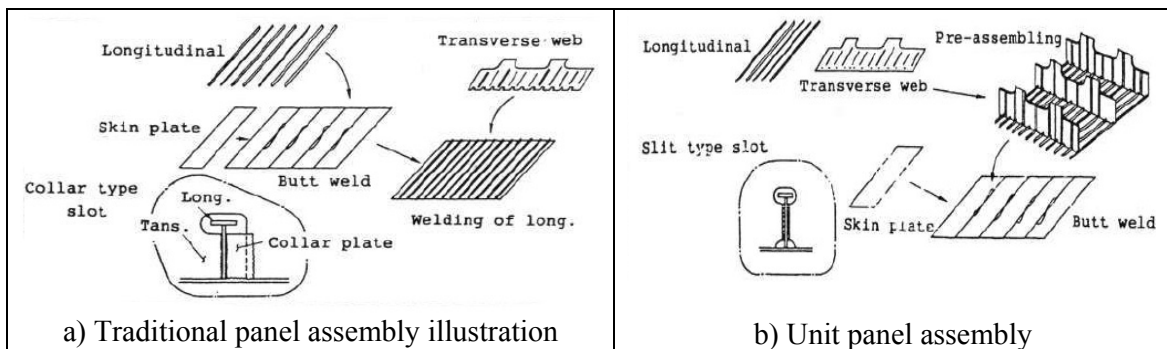


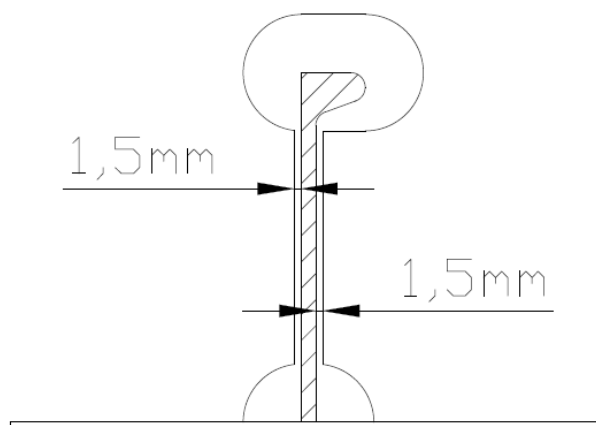
Fig. 3.66. Unit panel and slot construction—sliding on transverses [4]

The automatic placement of longitudinals on unit panels is controlled by one operator at the control panel (See Figure 3.65a). This is in contrast to traditional panel lines, where longitudinals are fitted one by one with multiple workers (fitters). This means that the man-hours for fitting longitudinals are at least four times lesser in the automated one-piece-flow facility [16], [10]. After the longitudinals are fitted, they are then automatically welded with only one operator at the control panel. In traditional panel lines, the welding is handled by at least four welders. Therefore the welding times are also four times smaller for the lean method as opposed to the traditional method (See Figure 3.65b).

Finally the transverses are slid over the longitudinals in a smooth flowing action. In traditional panel lines, transverses with cut-outs instead of slits are placed over the longitudinals. Then fitters adjust the transverses until they are finally in the correct position. Afterwards, the transverses are welded to the bed plate, usually manually. Finally, lugs are fitted and welded in order to meet strength requirements of the classification society. The unit panel and slit construction involves the sliding of transverses through the longitudinals. This sliding inherently takes advantage of built-in quality because of the slit with minimal clearance of 1.5 mm. Therefore quality control is performed during working time. This is an elimination of the non-added value work of additional accuracy control which is necessary with traditional panel-block lines where the transverses have cut-outs. Finally, the traditional collar type slot or cut-out requires additional work for the fitting and welding of collar plates or lugs (See Figure 3.67a). This additional work of adding collar plates or lugs is avoided in the advanced or better called lean assembling panel-block assembly line since the slit type slots eliminate the need for lugs or collar plates (See Figures 3.67b and 3.68).



**Fig. 3.67. a) Traditional panel assembly vs. b) Unit panel assembly illustration [10]**



**Fig. 3.68. Detail of slot for a bulb profile [10], [30]**



## 4. DFP CASE STUDY

The aim of this case study is to evaluate the production process of the 3.Maj shipyard according to the DFP and lean manufacturing principles. The case study includes analysis of blocks (sections) of the parallel middle body of three vessels, particularly double bottom blocks, which are assembled from flat panels, built up panels, webs and elements manufactured from the shipyard production lines. The method of assembling blocks will be described and analyzed with the aim of confirming the optimal method, in compliance to the present technology level of the shipyard, and the creation of a **type plan** for block assembly. The manufacture of elements, panels and blocks (sections) in the sub-assembly workshop, technological constraints, and characteristic types of interim products will all be defined in this study. On the shipyard layout plan, the main production areas will be identified.

### 4.1. RATIONALYZING SHIPYARD DESIGNS

In order to raise the shipyard compliance level to DFP and PWBS methods, it is necessary to analyze the vessel production program. The interim products of the parallel middle body of any type of cargo vessel lend themselves to application of similarity and therefore repeatability in production processes. The analysis process is dependent on the strategic orientation of management towards creating an interaction between designers and production or field engineers [28]. Therefore, in order to standardize the interim product manufacturing processes and to maximize its repeatability in those same processes, it is necessary to make an analysis of the production program of 3.Maj shipyard which includes 3 vessels [2], [30]:

- 49000/51800 DWT Tanker for the transport of oil, oil products and chemicals (Chemical tanker),
- 12300 DWT RO-RO vessel for automobile transport (Car carrier),
- 6300 DWT Deck Cargo Barge with Crane Fitted on Deck (Crane barge).

The interim products analyzed are flat panels designated P, built-up panels designated KP, which form the basis for the assembly of blocks ready for erection. Since the assembly lines produce flat panels, bent panels are excluded from the analysis. The mid-ship sections and main characteristics of the vessels chosen for analysis are shown in Figures 4.1 - 4.3. Figures 4.4 - 4.6 illustrate the parallel middle-body rings of all three vessels, broken down into sections (assembly units).

The detailed analysis of the interim-product characteristics from the panel assembly line and built-up panel line results in the decision to analyze the following sections of the parallel middle body, in parallel for the three subject vessels [2], [30]:

- Double bottom block of the chemical tanker and car carrier,
- Entire parallel middle body (for the barge)





Loa = 195,30 m  
 Lpp = 187,30 m  
 B = 32,20 m  
 H = 17,80 m  
 $T_{\text{design}} = 12 \text{ m}$   
 $T_{\text{scantling}} = 12,5 \text{ m}$   
 $\Delta_{\text{design}} = 4900 \text{ dwt}$   
 $\Delta_{\text{scantling}} = 51800 \text{ dwt}$

**Fig. 4.1. Chemical tanker [30]**



Loa = 176 m  
 Lpp = 165 m  
 B = 31,10 m  
 H = 30 m  
 $T_{\text{design}} = 7,71 \text{ m}$   
 $T_{\text{scantling}} = 8,766 \text{ m}$   
 $\Delta_{\text{design}} = 8400 \text{ dwt}$   
 $\Delta_{\text{scantling}} = 12300 \text{ dwt}$   
 4900 automobiles

**Fig. 4.2. Car carrier [30]**



Loa = 78,50 m  
 B = 31 m  
 H = 4,5 m  
 $T_{\text{design}} = 2 \text{ m}$   
 $T_{\text{scantling}} = 3,40 \text{ m}$   
 $\Delta_{\text{design}} = 2850 \text{ dwt}$   
 $\Delta_{\text{scantling}} = 6300 \text{ dwt}$

**Fig. 4.3. Crane barge [30]**

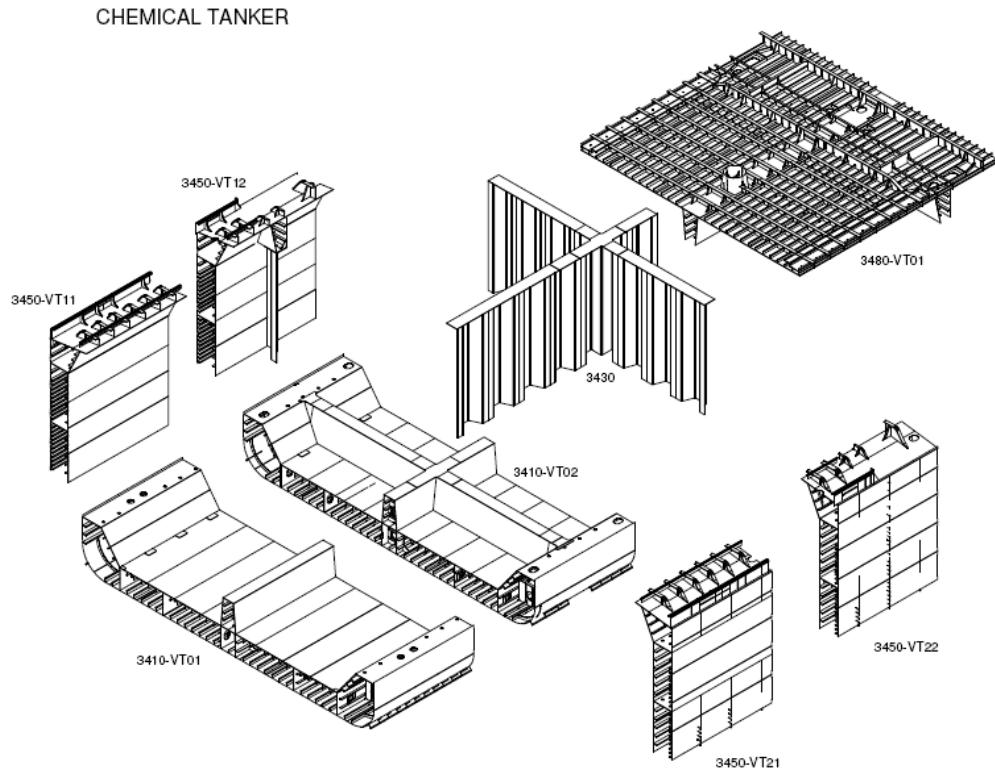


Fig. 4.4. Chemical tanker breakdown of the parallel middle-body ring [30]

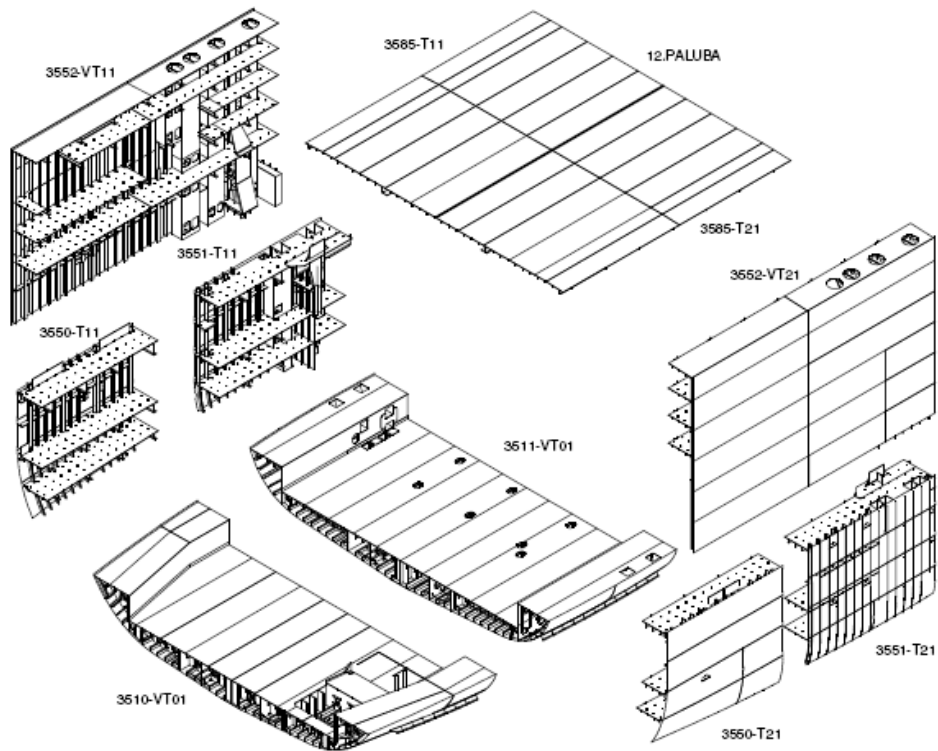
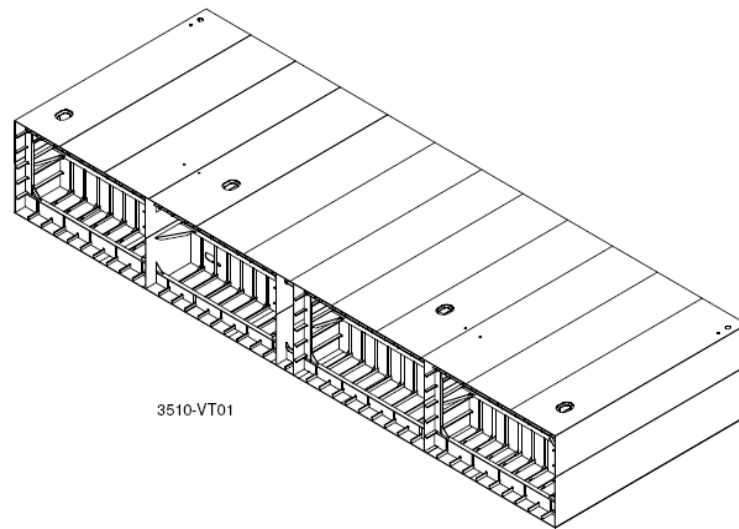


Fig. 4.5. Car carrier breakdown of the parallel middle-body ring [30]



**Fig. 4.6. Crane barge illustration of the parallel middle body ring [30]**

Based upon 3.Maj shipyard design documentation, a list of design variations and structural configurations of panels and built-up panels within typical blocks of the parallel middle-body for all three types of vessels is made.

#### **4.1.1. Design configuration analysis**

The key design areas of variation to be analyzed include (See Tables 4.1 – 4.4) [2]:

- Steel plate thickness and number of steel plates in one panel,
- Longitudinal scantlings,
- Type of longitudinal cross section,
- Spacing of longitudinals,
- Number of longitudinals per panel,
- Spacing of webs,
- Number of webs per panel,
- Depth of webs,
- Panel dimensions,
- Panel weight,
- Block weight,
- Steel quality,
- Direction of plate straking.

**Tab. 4.1. Design variations – Chemical tanker double skin blocks [2], [30]**

<b>Chemical Tanker</b>					
<b>No.</b>	<b>Key areas of variation</b>	<b>Double-Bottom</b>			
		<b>Group 3410 - VT02 Erection Block (See Figure 4.4)</b>			
		<b>KP12 double bottom top</b>	<b>KP22 double bottom top</b>	<b>P121 outer hull bottom</b>	<b>P221 outer hull bottom</b>
1	<b>Plate thickness Number of plates per panel</b>	16 mm 4 plates per panel	16 mm 4 plates per panel	15, 17,5 mm 5 plates per panel	15 mm 4 plates per panel
2	<b>Longitudinal scantlings</b>	longitudinals 370x13, 2 longitudinal girders 2180x16, 2180x14,5 tunnel 2180x20	longitudinals 370x13, bars 180x13 2 longitudinal girders 2180x16, 2180x14,5 tunnel 2180x20	longitudinals 340x14, bar 250x16	longitudinals 340x14
3	<b>Type of section</b>	HP / plate	HP / bar / plate	HP / bar	HP
4	<b>Longitudinal spacing (mm)</b>	800	800	800	800
5	<b>No. of longitudinals per panel</b>	12 longitudinals 2 longitudinal girders tunnel	12 longitudinals 1 bar 2 longitudinal girders tunnel	13 longitudinals 1 bar	13 longitudinals
6	<b>Spacing of webs (mm)</b>	1700/3400	1700/3400	x	x
7	<b>No. of webs per panel</b>	4	4	x	x
8	<b>Depth of webs (mm)</b>	2180	2180	x	x
9	<b>Panel dimensions</b>	11046x11998	11046x12078	11046x14336	11046x11876
10	<b>Panel weight (t)</b>	52 t	55,3 t	27,6 t	27,6 t
11	<b>Block weight (t)</b>	272 t	272 t	272 t	272 t
12	<b>Steel quality</b>	A	A	A	A
13	<b>Direction of plate straking</b>	longitudinal bow-stern	longitudinal bow-stern	longitudinal bow-stern	longitudinal bow-stern

**Tab. 4.2. Design variations – car carrier double skin blocks [2], [30]**

<b>Car Carrier</b>					
<b>No.</b>	<b>Key areas of variation</b>	<b>Double-Bottom (See Figure 4.5)</b>			
		<b>Group 3510 - VT 01 Erection Block</b>		<b>Group 3511 - VT01 Erection Block</b>	
		<b>KP 11 double bottom top</b>	<b>KP21 double bottom top</b>	<b>KP11 double bottom top</b>	<b>KP21 double bottom top</b>
1	<b>Plate thickness Number of plates per panel</b>	12 mm 5 plates per panel	12 mm 2 plates per panel	12 mm 5 plates per panel	12 mm 5 plates per panel
2	<b>Longitudinal scantlings</b>	Longitudinals 300x11 2 long. girders 2080x12, 2080x24 bottom centerline girder 2080x19	Longitudinals 300x11 1 long. girder 2080x12	Longitudinals 300x11 2 long. girders 2080x12, 2080x24 bottom centerline girder 2080x19	longitudinals 300x11 2 longitudinal girders 2080x12, 2080x24
3	<b>Type of section</b>	HP / T assembly / plate	HP / T assembly	HP / T assembly / plate	HP / T assembly
4	<b>Longitudinal spacing (mm)</b>	750	750	750	750
5	<b>No. of longitudinals per panel</b>	11 longitudinals 2 longitudinal girders bottom centerline girder	5 longitudinals 1 longitudinal girder	13 longitudinals 2 longitudinal girders bottom centerline girder	13 longitudinals 2 longitudinal girders
6	<b>Spacing of webs (mm)</b>	3400	3400	3400	3400
7	<b>No. of webs per panel</b>	4	4	3	3
8	<b>Depth of webs (mm)</b>	2080	2080	2080	2080
9	<b>Panel dimensions</b>	11746x12059	11746x4606	12796x12059	12796x11909
10	<b>Panel weight (t)</b>	40,8 t	15,1 t	43,9	39,7 t
11	<b>Block weight (t)</b>	168,5 t	168,5 t	184,7 t	184,7 t
12	<b>Steel quality</b>	A	A	A	A
13	<b>Direction of plate straking</b>	longitudinal bow-stern	longitudinal bow-stern	longitudinal bow-stern	longitudinal bow-stern

**Tab. 4.3. Design variations – crane barge double skin blocks [2], [30]**

<b>Crane Barge</b>						
<b>No.</b>	<b>Key areas of variation</b>	<b>Ring</b>				
		<b>Group 3510 - VT01 Erection Block (See Figure 4.6)</b>				
		<b>KP11 bottom</b>	<b>KP12 deck</b>	<b>KP13 (KP23) longitudinal blkhd</b>	<b>KP14 (KP24) transverse blkhd</b>	<b>KP31 bottom</b>
1	<b>Plate thickness Number of plates per panel</b>	15 mm 4 plates per panel	15 mm 4 plates per panel	12, 15 mm 2 plates per panel	10 mm 2 plates per panel	15 mm 3 plates per panel
2	<b>Longitudinal scantlings</b>	longitudinals 160x9	longitudinals 180x9	longitudinals 160x9 120x8	vertical stiffeners	longitudinals 160x9
3	<b>Type of section</b>	HP	HP	HP	HP	HP
4	<b>Longitudinal spacing (mm)</b>	750	750	750	750	750
5	<b>No. of longitudinals per panel</b>	10 longitudinals	10 longitudinals	5 longitudinals	9 vert. stiffeners	9 longitudinals
6	<b>Spacing of webs (mm)</b>	2000	2000	2000	at half height of the ring 2250 T assembly transverse on stiffening	2000
7	<b>No. of webs per panel</b>	5	5	5	1	5
8	<b>Depth of webs (mm)</b>	600	600	400	600	735
9	<b>Panel dimensions</b>	11000x8980	11000x8110	11000x4500	7485x4500	11000x7345
10	<b>Panel weight (t)</b>	16,2 t	15,4 t	6,6 t	3,7 t	14,7 t
11	<b>Block weight (t)</b>	175,7 t	175,7 t	175,7 t	175,7 t	175,7 t
12	<b>Steel quality</b>	A	A	A	A	A
13	<b>Direction of plate straking</b>	longitudinal bow-stern	longitudinal bow-stern	longitudinal bow-stern	transverse port-stbd.	longitudinal bow-stern

**Tab. 4.4. Design variations – crane barge double skin blocks [2], [30]**

<b>Crane Barge</b>					
<b>No.</b>	<b>Key areas of variation</b>	<b>Ring</b>			
		<b>Group 3510 - VT01 Erection Block</b> (See Figure 4.6)			
		<b>KP32 deck</b>	<b>KP33 (KP43) longitudinal blkhd</b>	<b>KP34 (KP44) transverse blkhd</b>	<b>KP53 (KP63) side shell</b>
1	<b>Plate thickness Number of plates per panel</b>	15 mm 3 plates per panel	12, 15 mm 2 plates per panel	10 mm 2 plates per panel	12, 15 mm 2 plates per panel
2	<b>Longitudinal scantlings</b>	longitudinals 180x9	longitudinals 160x9 120X8	vertical stiffening	longitudinals 160x9 120X8
3	<b>Type of section</b>	HP	HP	HP	HP
4	<b>Longitudinal spacing (mm)</b>	750	750	750	750
5	<b>No. of longitudinals per panel</b>	9 longitudinals	5 longitudinals	9 vertical stiffeners	5 longitudinals
6	<b>Spacing of webs (mm)</b>	2000	2000	at half height of the ring 2250 T assembly transverse on stiffening	2000
7	<b>No. of webs per panel</b>	5	5	1	5
8	<b>Depth of webs (mm)</b>	600	400	600	400
9	<b>Panel dimensions</b>	11000x7702	11000x4500	7488x4500	11000x4500
10	<b>Panel weight (t)</b>	14,7 t	6,6 t	3.7 t	6,6 t
11	<b>Block weight (t)</b>	175,7 t	175,7 t	175,7 t	175,7 t
12	<b>Steel quality</b>	A	A	A	A
13	<b>Direction of plate straking</b>	longitudinal bow-stern	longitudinal bow-stern	transverse port-stbd	longitudinal bow-stern

Based upon the design variations of the panels from the parallel middle body for the three analyzed vessel types from the previous tables, the following can be concluded (See Tables 4.1- 4.4) (See Appendix Tables A1 – A8) [2], [17], [30], [31]:

1. Steel plate thickness and number of plates within one panel.
  - Chemical tanker: steel plate thickness varies between 10 -17.5 mm with 4-5 plates per panel in the double bottom block;
  - Car carrier: steel plate thickness is 12 mm with 2-5 plates per panel in the double bottom block
  - Crane barge: steel plate thickness varies between 10, 12 and 15 mm, with 2-4 plates per panel.
  - Necessary to consider greater equalization of steel plate thicknesses within a panel, and choosing the optimal between interacting requests - for the mass to be as small as possible while the structure to be compliant to production as possible,
  - The number of plates in one panel depends on the breakdown of the hull into sections.
2. Longitudinal stiffening
  - Chemical tanker has HP (Holland profile) longitudinals, bars and girders,
  - Car carrier has HP longitudinals, bars and girders
  - Crane barge also has HP longitudinals, and girders.
  - The longitudinals are straked in the same direction as the steel plates, and it is not necessary to turn the plates in another direction on the panel line,
  - Spacing of the longitudinals varies depending on the type of vessel 750 / 800 / 850 mm. A standard longitudinal spacing for all vessel types should be considered from a DFP standpoint.
  - Number of stiffeners per panel varies depending on panel dimensions and spacing.
3. Transverse webs
  - Basic spacing of the webs is 3400 mm for the chemical tanker and the car carrier, and 2000 mm for the crane barge,
  - It is important to note that the crane barge design was not conducted by the shipyard engineers and designers. This is evident due to greater aberrations of standard characteristics,
  - Number of webs varies depending on the panel dimensions and structural specifications,
  - Web height varies from block to block due to structural reasons.
4. Dimensions and mass of panels
  - Dimensions and mass of the panels are in compliance to the production capabilities of the panel line and the built-up panel line,
  - Panel mass is relatively small in relation to the mass of the block (erection units) – reason – constraints to the panel line of 25 t, on the built up panel line of 50 tons, gantry crane on the slipway of 300 tons.
5. Steel quality
  - Grade A.
6. Direction of steel plate straking
  - Always longitudinal stern-bow (transverse side to side with transverse bulkheads)



#### 4.1.2. Structural configuration variation analysis

The structural configuration characteristics for analysis include (See Tables 4.5 - 4.8) [2], [17], [30]:

- Penetrations of longitudinals through transverses or webs (See Appendix Fig. A1),
- Webs stiffeners and configuration,
- Air and drain holes.

**Tab. 4.5. Structural configuration variations – Chemical tanker double skin blocks [2], [30]**

<b>Chemical Tanker</b>					
<b>Blocks analyzed</b>		<b>Double bottom</b>			
		<b>Group 3410 - VT02 Erection Block (See Figure 4.4)</b>			
<b>Configuration</b>		<b>KP12 tank top of double bottom (inner bottom)</b>	<b>KP22 tank top of double bottom (inner bottom)</b>	<b>P121 bottom outer hull plating</b>	<b>P221 bottom outer hull plating</b>
<b>Longitudinal web penetration (panel stiffening)</b>	<b>Fitted slots</b>	X	X	X	X
	<b>One side fitted and one lug</b>	12	12	X	X
	<b>One side fitted without lug</b>	X	X	X	X
	<b>Tight collar</b>	X	X	X	X
	<b>Open cut-out without lugs</b>	X	X	X	X
<b>Web stiffeners</b>	<b>stiffener dimensions</b>	150x12	150x12	X	X
	<b>Stiffener type</b>	bar	bar	X	X
	<b>Connection with longitudinals</b>	Vertical, welded in line with longitudinals	Vertical, welded in line with longitudinals	X	X
<b>Web configuration</b>	<b>Web frame dimensions</b>	2180x12/13,5/14/16,5	2180x12/13,5/14/16,5	X	X
	<b>Type of web frame</b>	small sub assembly unit	small sub assembly unit	X	X
<b>Air holes</b>	<b>Adjacent to plate</b>	X	X	X	X
	<b>Off the plate</b>	X	X	X	X
<b>Drain holes</b>	<b>Adjacent to plate</b>	X	X	X	X
	<b>Off the plate</b>	X	X	X	X

**Tab. 4.6. Structural Configuration Variations – Car Carrier Double Skin Blocks [2], [30]**

<b>Car Carrier</b>					
<b>Blocks analyzed</b>		<b>Double bottom</b>			
		<b>3510-VT01 (See Figure 4.5)</b>		<b>3511-VT01 (See Figure 4.5)</b>	
<b>Configuration</b>		<b>KP11 double bottom top</b>	<b>KP21 double bottom top</b>	<b>KP11 double bottom top</b>	<b>KP21 double bottom top</b>
<b>Longitudinal web penetration (panel stiffening)</b>	<b>Fitted slots</b>	X	X	X	X
	<b>One side fitted and one lug</b>	6	3	8	8
	<b>One side fitted without lug</b>	5	2	5	5
	<b>Tight collar</b>	X	X	X	X
	<b>Open cut-out without lugs</b>	X	X	X	X
<b>Web stiffeners</b>	<b>stiffener dimensions</b>	150x10	150x10	150x10 bar 160x8 bulb - HP	150x10 bar 160x8 bulb - HP
	<b>Stiffener type</b>	bar	bar	bar, bulb - HP	bar, bulb - HP
	<b>Connection with longitudinals</b>	Vertical in line with longitudinals (bars and bulbs) horizontally btwn. vertical stiffeners (only bars)	Vertical in line with longitudinals (bars and bulbs) horizontally btwn. vertical stiffeners (only bars)	Vertical in line with longitudinals (bars and bulbs) horizontally btwn. vertical stiffeners (only bars)	Vertical in line with longitudinals (bars and bulbs) horizontally btwn. vertical stiffeners (only bars)
<b>Web configuration</b>	<b>Web frame dimensions</b>	2080x10/13/14/16	2080x10/13/14/16	2080x10/11/14/20	2080x10/11/14/20
	<b>Type of web frame</b>	small sub assembly unit	small sub assembly unit	small sub assembly unit	small sub assembly unit
<b>Air holes</b>	<b>Adjacent to plate</b>	X	yes	X	X
	<b>Off the plate</b>	X	X	X	X
<b>Drain holes</b>	<b>Adjacent to plate</b>	X	X	X	X
	<b>Off the plate</b>	yes	yes	yes	yes

**Tab. 4.7. Structural configuration variations – crane barge double skin blocks [2], [30]**

<b>Crane Barge</b>						
<b>Blocks analyzed</b>		<b>Ring</b>				
		<b>Group 3510 - VT01 (See Figure 4.6)</b>				
<b>Configuration</b>		<b>KP11 bottom</b>	<b>KP12 deck</b>	<b>KP13 (KP23) longl blkhd</b>	<b>KP14 (KP24) transverse blkhd</b>	<b>KP31 bottom</b>
<b>Longitudinal web penetration (panel stiffening)</b>	<b>Fitted slots</b>	X	X	X	X	X
	<b>One side fitted and one lug</b>	X	X	X	X	X
	<b>One side fitted without lug</b>	10	10	4	9	9
	<b>Tight collar</b>	X	X	1	X	X
	<b>Open cut-out without lugs</b>	X	X	X	X	X
<b>Web stiffeners</b>	<b>Stiffener dimensions</b>	80x10	100x10	X	10 mm	80x10
	<b>Stiffener type</b>	bar	bar	X	bracket	bar
	<b>Connection with longitudinals</b>	Vertical, welded in line with longitudinals	Vertical, welded in line with longitudinals	X	Vertical, welded in line with longitudinals	Vertical, welded in line with longitudinals
<b>Web configuration</b>	<b>Web frame dimensions mm</b>	600x200x10/15	600x230x10/15	400X120X10/15	600x230x10/15	735x200x12/15
	<b>Type of web frame</b>	T assembly small sub-assembly plate + bar	T assembly small sub-assembly plate + bar	T assembly small sub-assembly plate + bar	T assembly small sub-assembly plate + bar	T assembly small sub-assembly plate + bar
<b>Air holes</b>	<b>Adjacent to plate</b>	X	X	X	X	X
	<b>Off the plate</b>	X	X	X	X	X
<b>Drain holes</b>	<b>Adjacent to plate</b>	X	X	X	X	X
	<b>Off the plate</b>	X	X	X	X	X

**Tab. 4.8. Structural Configuration Variations – Crane Barge Double Skin Blocks [2], [30]**

<b>Crane Barge</b>					
<b>Blocks analyzed</b>		<b>Ring</b>			
		<b>Group 3510 - VT01 (See Figure 4.6)</b>			
<b>Configuration</b>		<b>KP32 deck</b>	<b>KP33 (KP43) longl. blkhd</b>	<b>KP34 (KP44) transverse blkhd</b>	<b>KP53 (KP63) side shell plating</b>
<b>Longitudinal web penetration (panel stiffening)</b>	<b>Fitted slots</b>	X	X	X	X
	<b>One side fitted and one lug</b>	X	X	X	X
	<b>One side fitted without lug</b>	9	4	9	4
	<b>Tight collar</b>	X	1	X	1
	<b>Open cut-out without lugs</b>	X	X	X	X
<b>Web stiffeners</b>	<b>Stiffener dimensions</b>	100x10	X	10 mm	X
	<b>Stiffener type</b>	bar	X	bracket	X
	<b>Connection with longitudinals</b>	Vertical, welded in line with longitudinals	X	Vertical, welded in line with longitudinals	X
<b>Web configuration</b>	<b>Web frame dimensions mm</b>	600x230x10/15	400x120x10/15	600x230x10/15	400X120X10/15
	<b>Type of web frame</b>	T assembly small sub-assembly plate + bar	T assembly small sub-assembly plate + bar	T assembly small sub-assembly plate + bar	T assembly small sub-assembly plate + bar
<b>Air holes</b>	<b>Adjacent to plate</b>	X	X	X	X
	<b>Off the plate</b>	X	X	X	X
<b>Drain holes</b>	<b>Adjacent to plate</b>	X	X	X	X
	<b>Off the plate</b>	X	X	X	X

Based on the list of structural characteristics the following can be observed [2], [17], [30], [31]:

1. Longitudinal penetrations
  - Three types of standard penetrations on all three types of vessels (See Appendix Figure A1):
    - P1, one side fitted, the other side has a lug,
    - P5, one side fitted without lug,
    - P6, collar (watertight penetration).
2. Configuration and stiffening of webs
  - Mainly T – assemblies of the small subassembly manufactured in the shipyard (steel plate + steel bar),
  - Vertical stiffeners in line with longitudinals – bars and brackets,
  - Horizontal stiffeners between verticals at high transverse girders at lightening holes.
3. Air holes and drain holes
  - Shifted from the steel panels – suitable for automatic welding.

From the above listed facts, it can be concluded that the designs complied to many principles of DFP which are simplicity of design in compliance to the production capabilities of the shipyard. The greatest aberrations are from the crane barge due to the fact that it was designed out of house [30]. During the coordination and project design improvement from the production aspect, it is necessary to continuously work on decreasing the design variations of panels and built-up panels [2], [17], [30]. This will help to improve the flow of interim products [25].

#### **4.2. ADJUSTING SHIPYARD PROCESSES ACCORDING TO DFP MANUFACTURING PRINCIPLES**

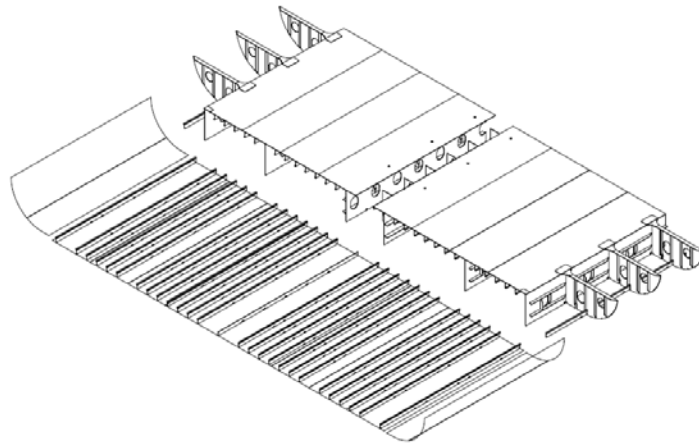
Upon analyzing the design variations and structural configurations of panels and built-up panels, the next step is to determine the most efficient method for block assembly according to DFP manufacturing principles. The lack of clearly defined interim product elements that are joined during block assembly, together with the lack of rational design details shows the necessity of developing a type plan which is optimal for the present state shipyard facilities.

In order to successfully adjust the engineering processes involved in block assembly, it is necessary to:

- Identify and choose the optimal assembly method for the present state of the shipyard,
- Analyze assembly of a typical double bottom block using the four categories of block assembly.

For analysis purposes a block with the following characteristics is used (See Figure 4.7) [2]:

Block type:	Double bottom 3410 VT 02 Chemical tanker
Block size:	10.50m x 31.100m x 2.18m
No. of panels:	4
No. of plates / panel:	5
No. of longitudinals per panel:	12
No. of transverse elements per panel:	3



**Fig. 4.7: Double bottom block 3410 VT02 of the Chemical tanker [30]**

**Tab. 4.9. Summary of work content analysis [30]**

Category	Weld Length (m)	Man-hours (hr)
1	2685	2930
2	2638	3077
3	2275	3633
4	2275	3809

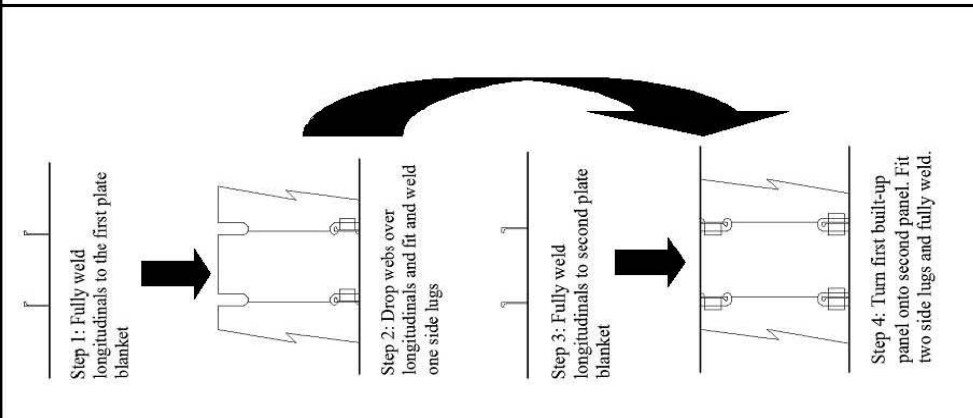
Table 4.9 above shows that as the categories change from 1 to 4, the weld length decreases because the cut-out opening is changed to the slot type opening in the transverse elements. However, in the man-hours column, the values increase because the change in the methodology has an effect of causing a significant change in “production technology in the areas of part cutting, accuracy control and stabilized assembly sequences and processes” [2]. The increased man-hours shows that changing the detailed design opening has on the static technology level of the shipyard [2]. When the technology is developed in parallel with the changing methodology, only then will there be a reduction of man-hours “corresponding to the reduction in weld length” [2], [14].

**Type plan development:**

Figures 4.8 - 4.9 illustrate the general description of the type plan for the assembly of the defined method 1-c which is used in 3.Maj shipyard with work phases and hull details.

In order to successfully execute the introduction of the methods it is necessary to complete a technological updating of the shipyard which would require the following [2], [30], [32], [33]:

- A complete compatibility program which is used in the creation of a model, drawings for the preparation of cutting elements, in order to gain a precise cut-out (slot) on the plate transverses (floors) which is a prerequisite for considering the application of these advanced methods;
- Determining the necessary surface areas of the work-stations;
- Introducing new tools for the needs of pushing-pulling longitudinals through the fitted slots of the webs (transverses);
- A different technological concept for the assembly of blocks (VT blocks in 3.Maj shipyard);
- The need for better organization and a more qualified work force in order to apply these new methods.

<p><b>Assembly Method 1c</b></p> 	<p><b>Possible Risk Areas</b></p> <p>1)The levels of accuracy are at satisfactory shipyard levels. However, in order to decrease man-hours, accuracy issues need to be treated “in order to eliminate rework associated with fitting webs to one-side fitted cut-outs in step 2” [2]. 2)“Alignment methods need to be improved for locating the built up panel onto the second panel in step 4” [2].</p>	<p><b>General Improvements</b></p> <p>1)“Improve methods and sequences for fitting and welding” [2]. 2)“Develop statistical process analysis of current accuracy control data and expand accuracy control activities” [2]. 3)“Identify the current bottlenecks in the assembly process and resolve them” [2]. 4)“Analyze the extent and causes of rework and eliminate them” [2]. 5)Improve the production process using lean methods.</p>	<p><b>Performance Improvement Initiatives</b></p> <ul style="list-style-type: none"> <li>➤ Improve the use of workers at each workstation through a PW/BS structure.</li> <li>➤ Define methods and processes clearly in a practical users manual.</li> <li>➤ Increase the use of robotics and automation.</li> <li>➤ Production engineers should combine the use of accuracy control and statistical analysis.</li> <li>➤ Identify value added and non-value added work and work on minimizing the non-value added activities.</li> </ul>
---	--	--	---

**Fig. 4.8. Typical block assembly type plan for present state – flat single and double skin blocks: general description [2] , [30]**

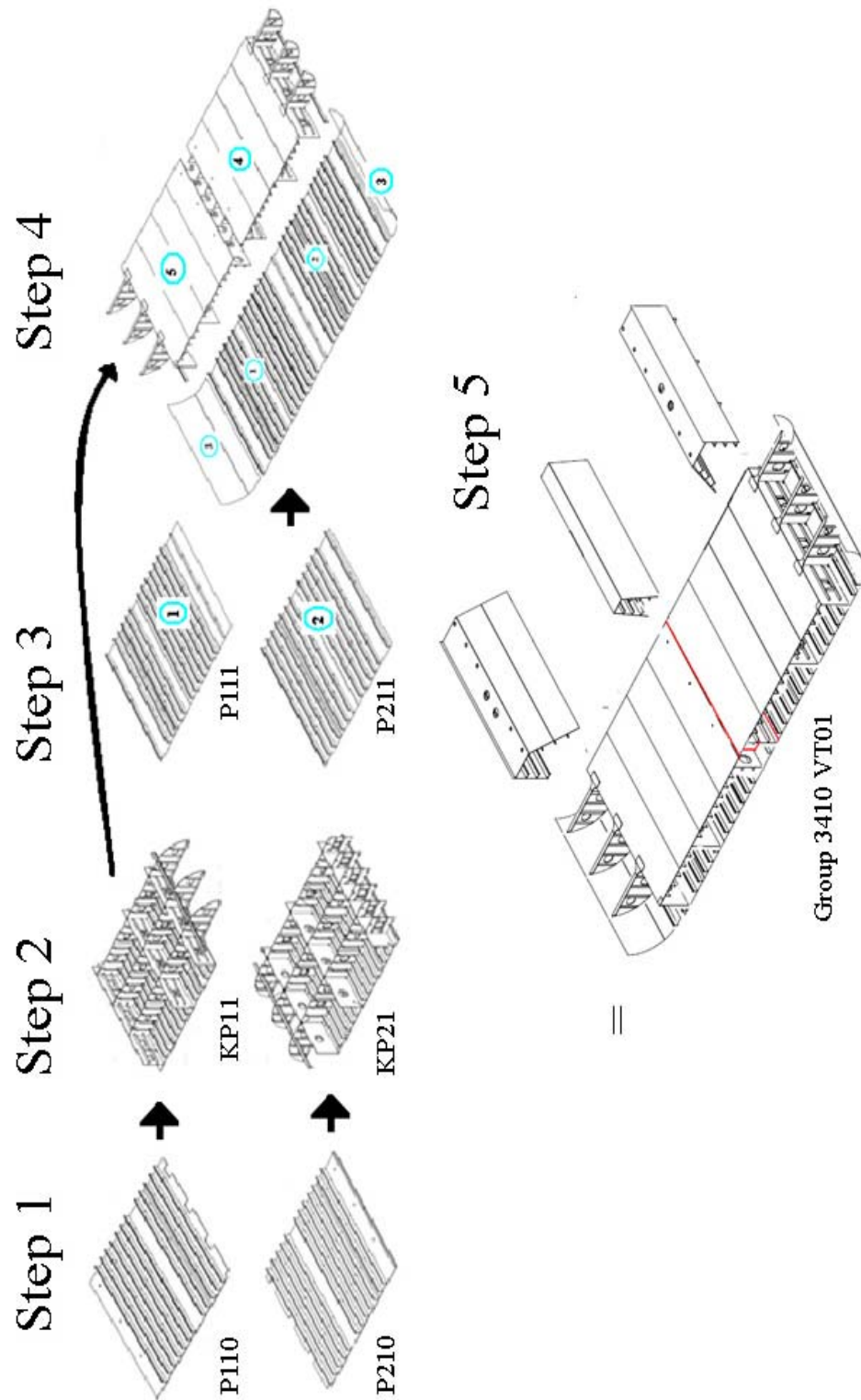


Fig. 4.9. General plan for assembling the double bottom 3410 VT01 of the Chemical tanker with work phases [30]



### 4.3. TARGETED SHIPYARD PRODUCTION PROCESSES

In the 3.Maj shipyard the production process of building a hull is broken down into four basic phases which are also organizational units [30], [32]:

- Preprocessing and processing of steel plates and profiles;
- Subassembly and Assembly;
- Anticorrosion protection;
- Erection.

The above listed production departments execute technological operations according to the defined building technology for each designed ship. Besides organization, the production departments are physically separated. Therefore the technological limitations are also affected by the characteristic transportation means between individual production phases as well as the dimensions of penetrations and doors. The pre-processing and processing of steel plates and profiles is the preparation phase of the production process which includes the storage, preprocessing and processing of steel plates and longitudinal stiffeners (profiles). Steel plates and profiles are stored in separate storage areas and the characteristics of the storage are the size of the work areas and capacities of the cranes used to handle and manipulate the steel. Steel plates are stacked together according to the technological group and newbuilding number, while profiles are strapped together [30], [33].

The steel plates and longitudinals are transported from the steel storage area and sent to the workshop for preprocessing where the steel is flattened (only steel plates, profiles are levelled during the processing phase), sand blasted, applied with primer and marked. The technological capabilities during the pre-processing phase of steel plates and profiles are determined by the characteristics of machines and equipment for pre-processing and dimensions of the painting chambers. The steel plates and longitudinals are treated in separate processing lanes. The treatment of steel plates and profiles includes the processes of cutting and forming (shaping). The characteristics of the cutting machines, machines for forming and transportation equipment with which production lines are equipped for processing, determines the technological constraints of the processing phases [30], [34], [35].

During the pre-assembly phase the processed steel plates and profiles are used to fabricate and manufacture elements, panels, flat and curved two-dimensional and three-dimensional blocks as well as large three-dimensional blocks. During this phase, outfitting works begin which are performed in parallel to hull works. Technological capabilities in this production phase are constrained by the number and size of the work areas, horizontal and vertical transportation means, panel lines, micropanel lines, built-up panel assembly lines (KP lines) and welding equipment [28], [30].

Anti-corrosion protection is a process which includes abrasive cleaning and paint application to blocks. Assembled blocks are delivered to the workstation for abrasive cleaning (grit blasting), and then transferred to the painting workshop where the anticorrosive layer is added according to the paint specifications. The maximum block dimensions are limited by the dimensions of the workshop for abrasive cleaning and painting [30], [34].

During the erection phase the hull consists of various sub-assembled interim products, from basic steel assembled elements to completely outfitted and anti-corrosion protected blocks. At the 3.Maj shipyard, erection is performed on the slipways for longitudinal launching. Hull building activities are done simultaneously with outfitting activities. The greater the

dimensions and degree of outfitting of the blocks, the shorter is the cycle time to launching, and therefore final delivery to the owner. The slipway characteristics upon which the hull is erected, the crane capacity of the slipway and the welding equipment determines the technological capabilities within the erection framework [2], [30].

This section describes four automated lines in the sub-assembly and assembly phases of 3.Maj shipyard. Likewise the description of the manufacture of a large three-dimensional block of the parallel middle-body which consists of a great portion of the interim products of the production lines is presented.

#### **4.3.1. Technological constraints of subassembly and assembly**

The technological constraints of the production process represents a framework within which the hull structure is broken into blocks and further into panels and built-up panels. According to DFP principles, the maximal utilization of the present shipyard capabilities is recommended [2], [30].

The technological capabilities of the shipyard are defined by the basic characteristics of machinery, equipment, work areas and transport means which take part in the production process.

#### **4.3.2. Block assembly during the assembly phase**

##### **4.3.2.1 Micropanel-line**

The production processes along the sub-assembly and assembly lines are designed so that material and interim products travel through the process (they are transported) while the equipment and operators stand along their work positions. Micropanel lines are in the shipbuilding hall. Along the micropanel line, welding is performed similar to the panel line with submerged arc welding equipment (See Appendix Figure A2). The only difference is that the elements (steel plates and bars) are much smaller, as on the robotic line, and the elements are transported by small wagons [30], [34]. Elements fabricated on the micro-panel line are micro-panels (webs, floors, swash bulkheads, etc.), defined as CA and designed by the Hull Technology department of 3. Maj shipyard. Interim products from the micro-panel line are set in specially manufactured palets, and are transferred with a crane to the built-up panel (KP) assembly assembly line [30], [34] (See Figure 4.10 and Appendix Figures A3 and A5).



**Fig. 4.10. Palet for micropanels [30]**

### 4.3.2.2 Robotic line

3.Maj shipyard possesses a robotic welding line for the fabrication of sub-assembled elements (See Appendix Figures A4 and A6). This production line is in compliance to the need for greater productivity, which includes increasing welding speed, improving final quality, improving welder work conditions. The robotic line is automated and the complete area is located in a closed hall. The introduction of the robotic line to the 3.Maj shipyard has significantly reduced manual work during the manufacturing phase of sub-micro assemblies of the hull. This decrease in manual work has increased productivity and also decreased the chance of welding aberrations as a result of human error [30], [34]. Therefore, the lean principle of maintaining and improving flow of interim products is upheld [25].

Due to the needs of eliminating manual exact positioning of micro-panels along the production line, the robotic system is replaced with on-line programming and machine recording support. This occurs by first recording the position of the working element placed on the surface of the line and then direct programming is performed on the production line. The robotic line contains a semi-portal upon which welding equipment exists; video camera for recording micropanels and a PC computer with which programming is performed. The floor of the line is made of inserted bars for insuring negative potential of the concrete with work dimensions 52 x 4 m. The line is controlled by an operator who takes into account all essential robotic functions during preparation and work activities with the aid of the computer monitor [30], [34].

The actual choosing of macro parameters is performed with the aid of dropped menus whose values are entered in a database while the welding heights are entered in a database and connected with welding parameters. Welds which dominate on the line are horizontal fillet welds and vertical fillet welds [30], [34].

Typical elements fabricated on the robotic line include micropanels designated with CR (See Figure 4.11). The fabricated elements are then transported by the same crane used for transporting micropanels from the micropanel line described above (See Appendix Figure A3).

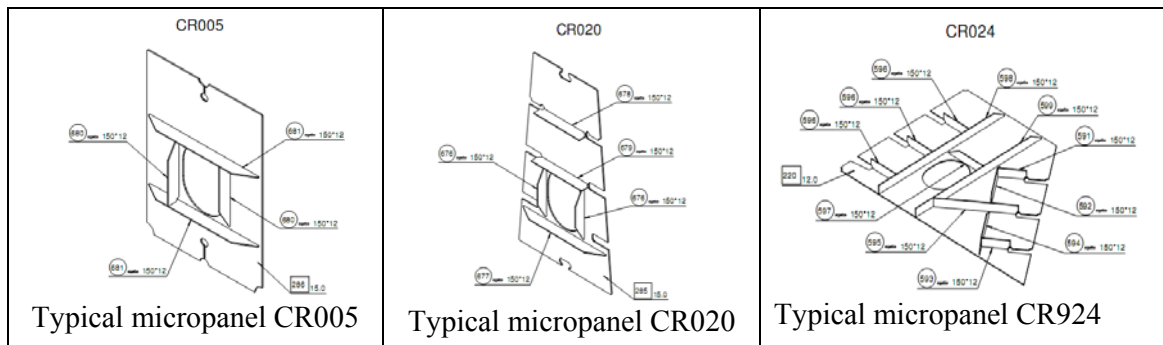


Fig. 4.11 Typical micropanels [30]

### 4.3.2.3 Panel line

The panel line is an automated line upon which steel plates are first assembled as a bed plate and then longitudinal stiffeners are fitted and welded to the bed plate which results in a stiffened panel. It is located in the extension of the shipbuilding hall for the fabrication of hull

elements. Its role comes to full prominence during the assembly of panels for large three-dimensional blocks of the parallel middle-body of vessels. Upon completion of stiffened panels, they are transported by a crane to the next assembly area which is the built-up panel (KP) assembly or the sub-assembly area where blocks are assembled (eg. Double-bottom blocks) [30], [33].

Basic characteristics of the automated panel line [30], [32], [33]:

- Reduces the total hull building time,
- Mechanized and automated activities and work procedures,
- Improved interim product quality,
- Savings in time and space.

The panel-line has five workstations (See Figure 4.12) [2], [30], [32], [34]:

**Workstation 1: DFP activities 1 and 2** (See Section 3.5): joining and welding of the first side;

**Workstation 2 : DFP activity 2** (See Section 3.5): turning over and rotating, welding of the second side;

**Workstation 3: DFP activity 3** (See Section 3.5): marking, autogenic cutting, ultrasound control;

**Workstation 4: DFP activities 4 and 5** (See Section 3.5): fitting and welding of longitudinal stiffeners;

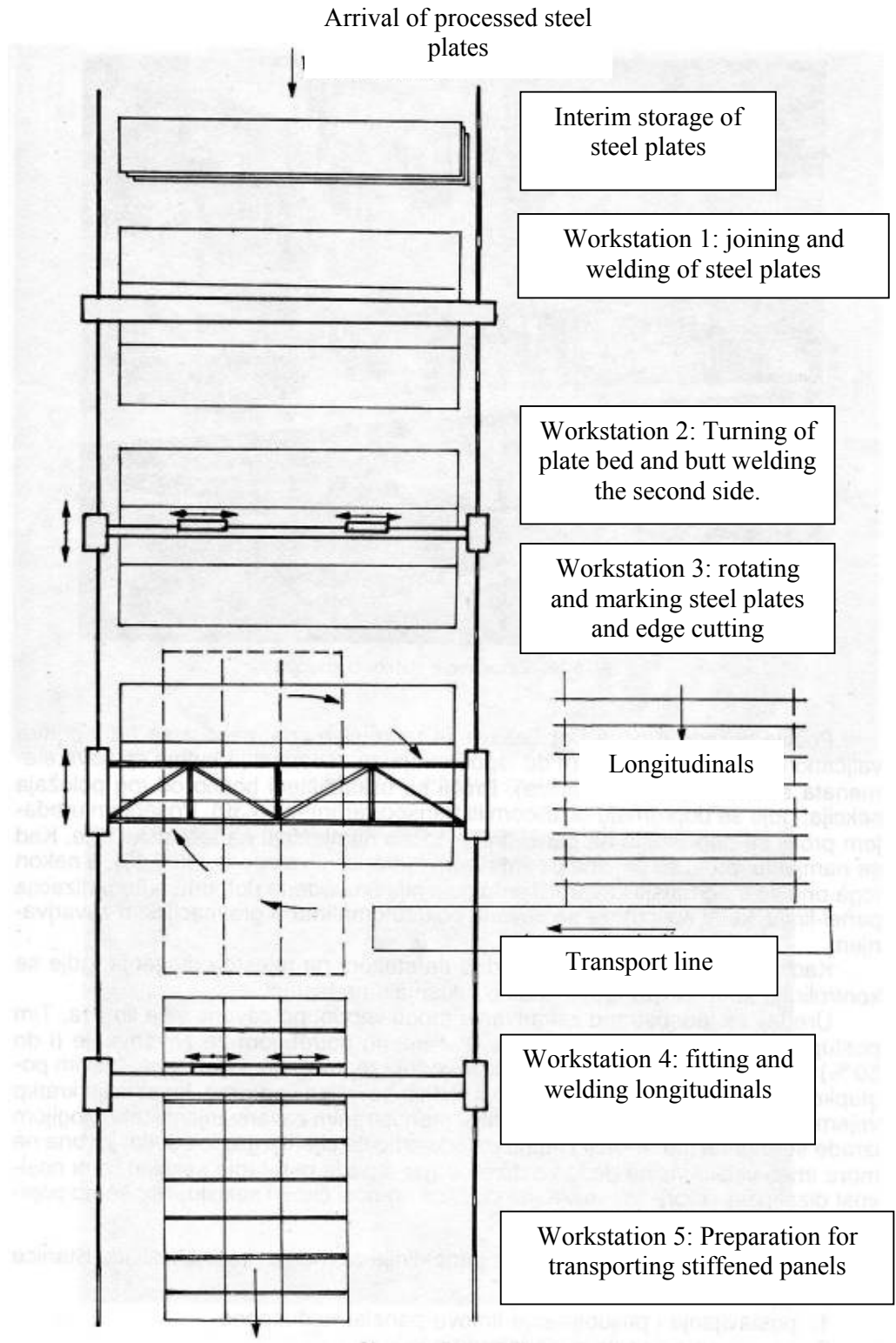
**Workstation 5:** laying down of panel and preparing for transport.

Panels are transported by way of special chains. The chains are guided within profiles on rollers. Each work area has a special drive through a drive mechanism with a hydraulic coupling in the electric motor. The transporters are controlled from a console, located to the side along the panel line. The man-hours broken down by trade and vessel type are listed below (See Table 4.10) [2], [30], [33].

**Tab. 4.10. Man hours for assembling a stiffened panel on the panel line for all three vessel types [30]**

Trades	Chemical tanker Group 3410 P121 (man-hours)	Car carrier Group 3511 P110 (man-hours)	Crane barge Group 3510 P120 (man-hours)
Ship fitters	11	8	6
Welders	25	20	16
Automaters	43,5	43	29
Markers	7,1	9,4	5,9
Cutters	5,1	5,3	7,7
Levelers	10,3	11,5	4
Grinders	12	13	10
<b>Total</b>	<b>114</b>	<b>110.2</b>	<b>78,6</b>

\*Note: Automaters are specialized workers trained to work on the panel-line for the fitting and welding of longitudinal stiffeners. P stands for panel [30].



**Fig. 4.12. Workstations on the panel line [32]**

#### 4.3.2.4 Built-up panel line (KP line)

The automated built-up panel (KP) line is a continuation of the panel line, but at a lower level due to the terrain of the 3.Maj shipyard. Presently, there is no practical way of connecting the panel and built-up panel lines, which would be better for flow. Bringing them to level would require major landscape and earth removing works which is not practical at this time. The built-up panel (KP) line receives stiffened panels from the automated panel line and elements from the micro-panel line and robotic line. Upon completion, a built-up panel is the end product. It is located indoors at “Cerovica C”, which is an assembly area (See Appendix Figure A7). The automated line was designed with four workstations. The KP line aims at takt production at these four workstations. Takt production along the workstations is performed by a crane instead of with a chain transporter, which would be more efficient and safer than transporting by way of crane. The man-hours broken down by trade and vessel type are listed below (See Table 4.11) The assembly of the built-up panels is summed up below [2], [30], [33]:

##### 1. i 2. Work stations 1 and 2: DFP Activity 6 (See Section 3.5)

- Receiving and sorting,
- Turning and levelling,
- Marking,
- Laying down and cutting,
- Tack welding,
- Marking for welding.

##### 3. Work station 3: DFP Activity 7 (See Section 3.5)

- Welding,
- Cleaning the weld,
- Transporting to workstation 4.

##### 4. Work station 4: DFP Activities 8 & 9 (See Section 3.5)

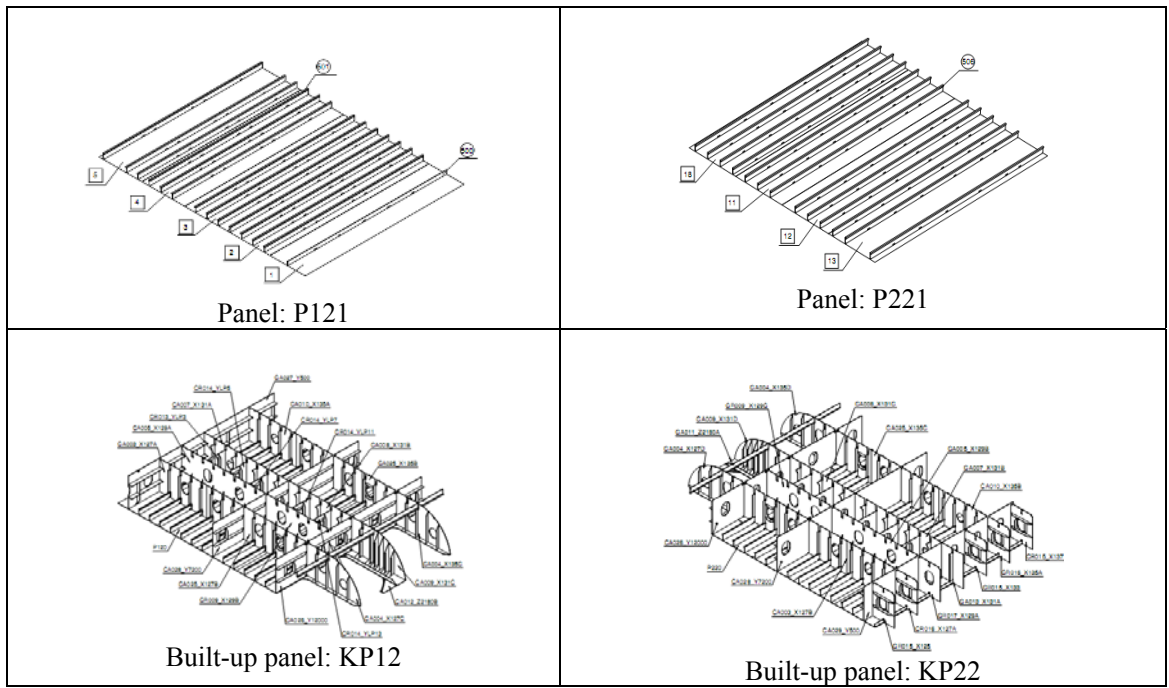
- Grinding,
- Fitting and welding ships equipment to the built up panel,
- Outfitting on block,
- Transport to “Cerovica D” for final three dimensional block assembly prior to erection on the slipway (See Section 3.5).

**Tab. 4.11. Man hours for assembling typical built-up panels for all three vessel types [30]**

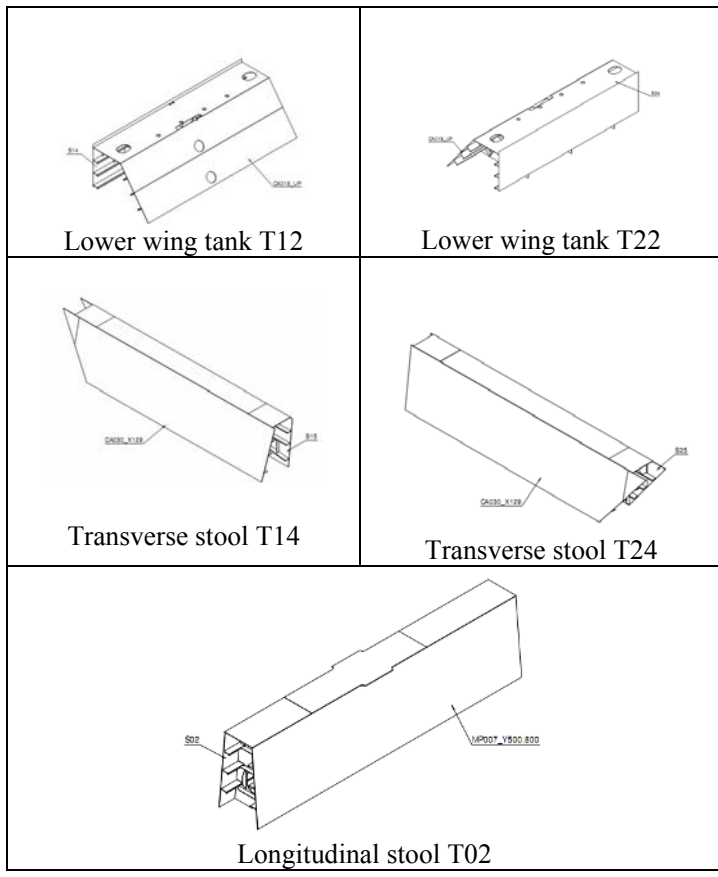
Trades	Chemical tanker Group 3410 KP 12 (man-hours)	Car carrier Group 3511 KP 11 (man-hours)	Crane barge Group 3510 KP 12 (man-hours)
Ship fitters	129	93	11
Welders	324	320	38
Markers	6	4	1
Grinders	81	62	10
Levelers	10	4	1
Groovers	2	2	1
<b>Total</b>	<b>552</b>	<b>485</b>	<b>62</b>

#### 4.3.2.5 Final block assembly prior to erection

Blocks are assembled at multiple locations at 3. Maj shipyard depending on their size and weight. Illustration of the interim products that make up double bottom block 3410 VT02 for the chemical tanker are illustrated (See Figures 4.13, 4.14 and 4.15) [30].



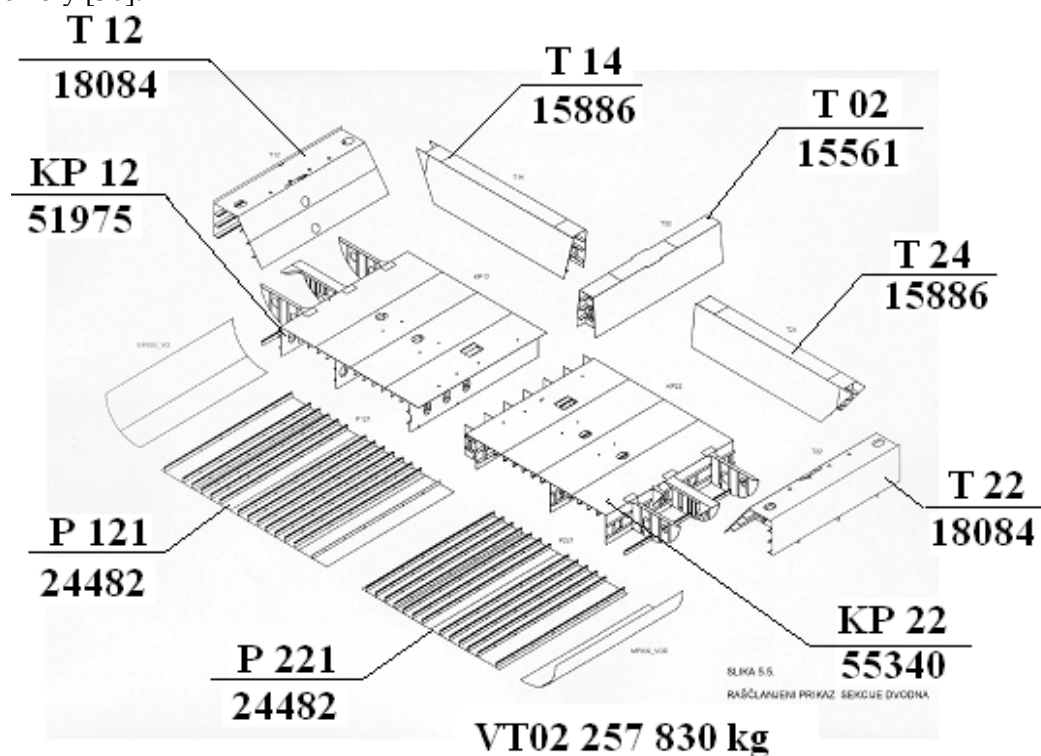
**Fig. 4.13. Panels and built-up panels of the Chemical tanker double bottom block [30]**



**Fig. 4.14. Three dimensional sections (T) [30]**

Double bottom block assembly starts with placing the outer hull panels P121 and P221 on level foundation blocks and fitting and welding them together. Then the double-bottom built-up panels KP12 and KP22 are fitted and welded on top. The turn of the bilge plates are then fitted and welded as well. The T-blocks which were assembled on static stations located on the periphery of the shipyard (See Figure 4.28) are then fitted on top. These T-blocks include the bottom wing tanks T12 and T22, as well as the longitudinal stool T02, and the transverse stools T14 and T24, which are fitted together to form the VT (very large three dimensional block) (See Figure 4.15). The man-hours for the assembly of the T-blocks for the entire group 3410 are listed in Table 4.12 below [30], [34].

Therefore the aforementioned production assembly is for a VT02 block (very large three dimensional block) of Chemical tanker group 3410. The assembly of VT02 group 3410 requires 5589 man-hours (Table 4.13), whereas the entire group requires 9361 man-hours for assembly [30].



**Fig. 4.15. Break down of VT02 block of the double bottom for group 3410 of the Chemical tanker [30]**

**Tab. 4.12. Man-hours for the assembly of three dimensional (T) blocks for the Chemical tanker [30]**

Trades	T-blocks (man-hours)		Total (man-hours)
	T01,T02,T14,T24	T11,T21,T12,T22	
Ship fitters	122	68	190
Welders	505	212	717
Grinders	122	68	190
Levelers	6	4	10
Groovers	16	14	30
<b>Total</b>	<b>771</b>	<b>366</b>	<b>1137</b>

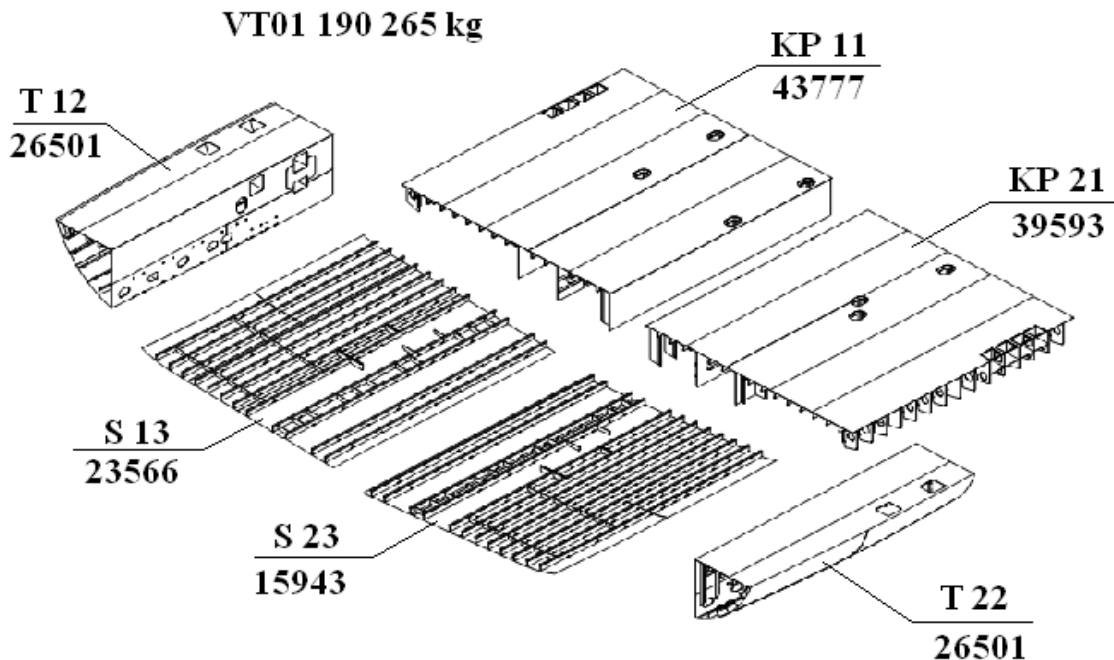


**Tab. 4.13. Breakdown of VT02 block, group 3410 for the Chemical tanker into man-hours and weight [30]**

Interim products	Man-hours	Mass tons (man-hours)
P121	114	27,56
P221	104,5	23,42
Small sub-assembly	646	N/A
KP12 + P120	552+98	51,98
KP22 + P220	592+104,5	55,34
T02 + S02	213+138	15,56
T12 + S14	98+97	18,08
T22 + S24	189+117,5	18,08
T14 + S15	189+117,5	15,89
T24 + S25	N/A	15,89
Curved steel plates x 2	N/A	12,6
Other: brackets, bars, collars, etc.	N/A	7,41
Assembly of VT02 block	2024	
<b>Total</b>	<b>5589</b>	<b>227,83</b>

**Car Carrier**

The double-bottom block of the Car carrier which derives from the parallel-middle body area contains the following interim products (See Figure 4.16). The bottom hull plating in contrast to the chemical tanker hull is made of curved panels (S13 and S23) that are therefore not assembled on the panel line. Then built-up panels (KP11 and KP 21) are fitted on the curved panels, along with two turn of the bilge tanks (T12 and T22 blocks). The total amount of time necessary for the manufacture of VT01 block of group 3511 is **4800** hours (See Table 4.13) [30].

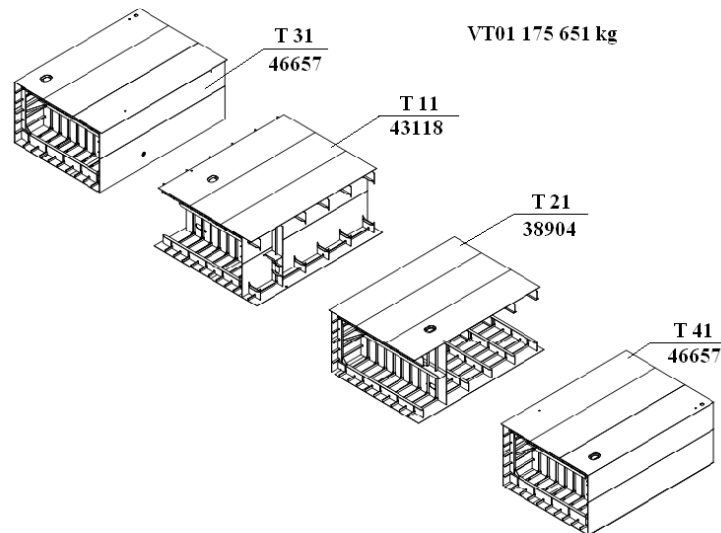
**Fig. 4.16. Breakdown of VT01 block of the double bottom for group 3511 of the Car carrier [30]**

**Tab. 4.14. Breakdown of VT01 block, group 3511 for the Car carrier into man-hours and weight [30]**

Interim products	Man-hours	Mass tons (man-hours)
KP11	485	43,8
KP21	N/A	39,6
T12	N/A	26,5
T22	N/A	26,5
S13	N/A	23,6
S23	N/A	23,6
Other: brackets, bars, collars, etc.	N/A	1,1
<b>Total</b>	<b>4800</b>	<b>184,7</b>

**Crane barge:**

The large three-dimensional (VT) block of the Crane barge contains four three-dimensional T-blocks along the entire beam. They are joined together and form the large three-dimensional (VT) double-bottom block (See Figure 4.17). Each T-block consists of built-up panels (bottom, decks, hull plating, longitudinal and transverse bulkheads) with man hours listed in Table 4.15. The built-up panels were not assembled on the KP assembly line due to the ring height of 4500 mm and the limitations of the built-up panel (KP) line is a maximum of 3500 mm [30].

**Fig. 4.17. Breakdown of group 3510 - T01 double bottom block for the Crane barge [30]****Table 4.15: Breakdown of VT01 block, group 3510, Crane barge into man-hours and weight**

Interim products	Man-hours	Mass tons
T31	N/A	46,66
T21	N/A	38,90
T41	N/A	46,66
T11	N/A	43,12
Other: brackets, bars, collars, etc.	N/A	0,37
<b>Total</b>	<b>4800</b>	<b>175,71</b>

**“Cerovica D”: Double bottom assembly area**

The following photograph shows the assembly area “Cerovica D” where double bottom blocks of various types of ships are built till the maximum weight of 300 tons [30].



**Fig. 4.18. “Cerovica D” assembly area [30]**

**4.3.3. Gantt charts of workstation activities**

Gantt charts illustrate the activities on the panel-line and the built-up panel lines during the assembly of panels and built-up panels respectively. The Gantt charts include the measured cycle time of individual activities per workstation and their relation in terms of activities which precede one another [2], [30]. For the implementation of a PWBS in a shipyard, Gantt charts are imperative [36]. In this way, production engineers can analyze the present work packages of interim product assembly and determine ways of decreasing the man-hours and the cycle time, thereby improving production. It is especially important prior to undertaking any type of changes to the assembly process, and for analyzing various solutions for future improvements to the process [37], [38] [39], [40]. The following Gantt charts illustrate the assembly of the panel with the designation P121 (5 steel plates, 13 longitudinals, mass of 27, 6 tons) and the built-up panel KP12 with a mass of 52 tons (See Table 4.1 and Figures 4.19 to 4.27). Please note that the activities with green font text and bars indicate value added activities (trammeling, tack welding, welding, cutting, grinding), whereas the other activities in black font and black bars indicate non-value added activities (setting up, transport, loading, moving).

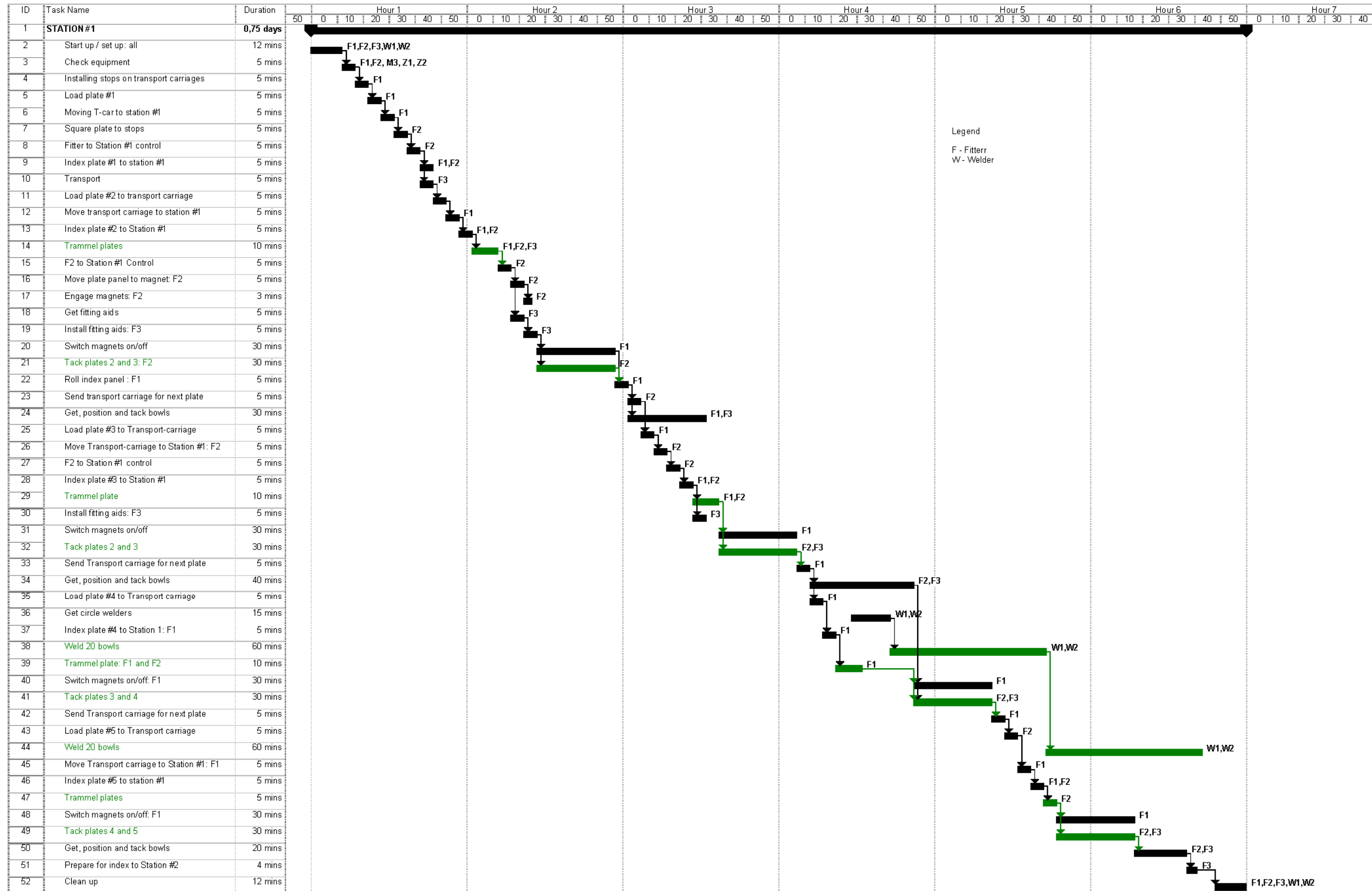


Fig. 4.19. Workstation 1 Gantt chart [2], [30]

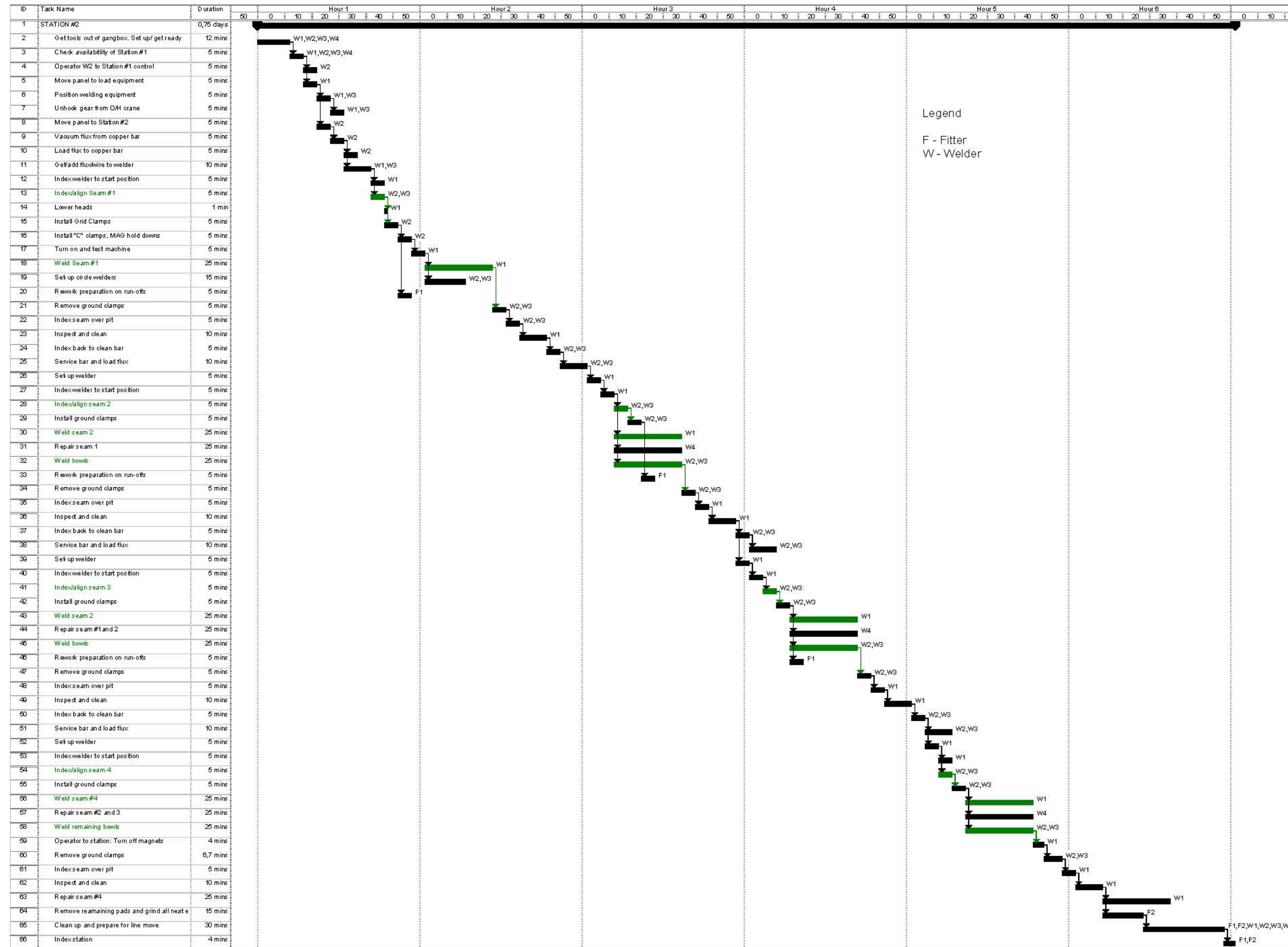


Fig. 4.20. Workstation 2 Gantt chart [2], [30]

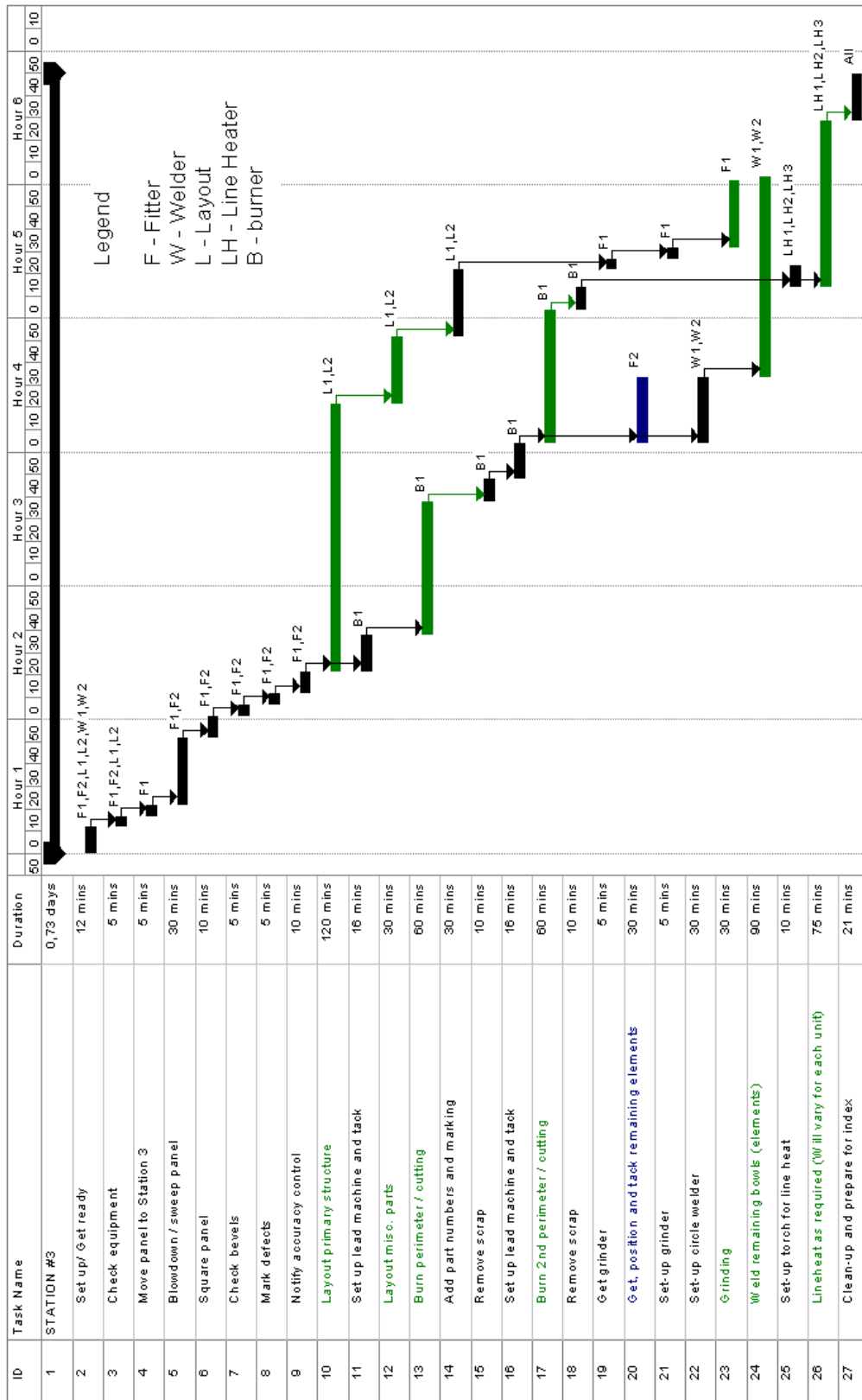


Fig. 4.21. Workstation 3 Gantt chart [2], [30]

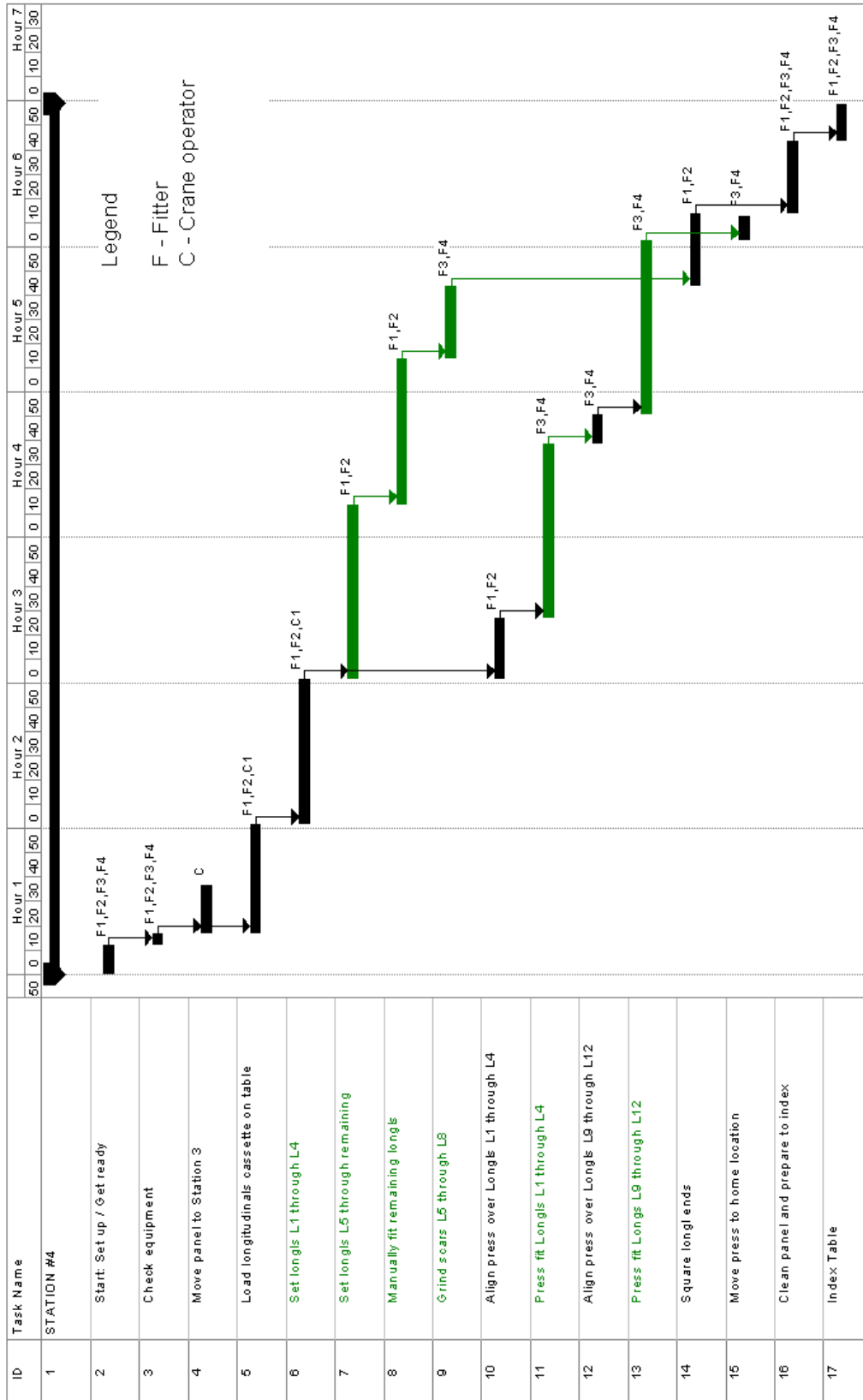


Fig. 4.22. Workstation 4 Gantt chart [2], [30]

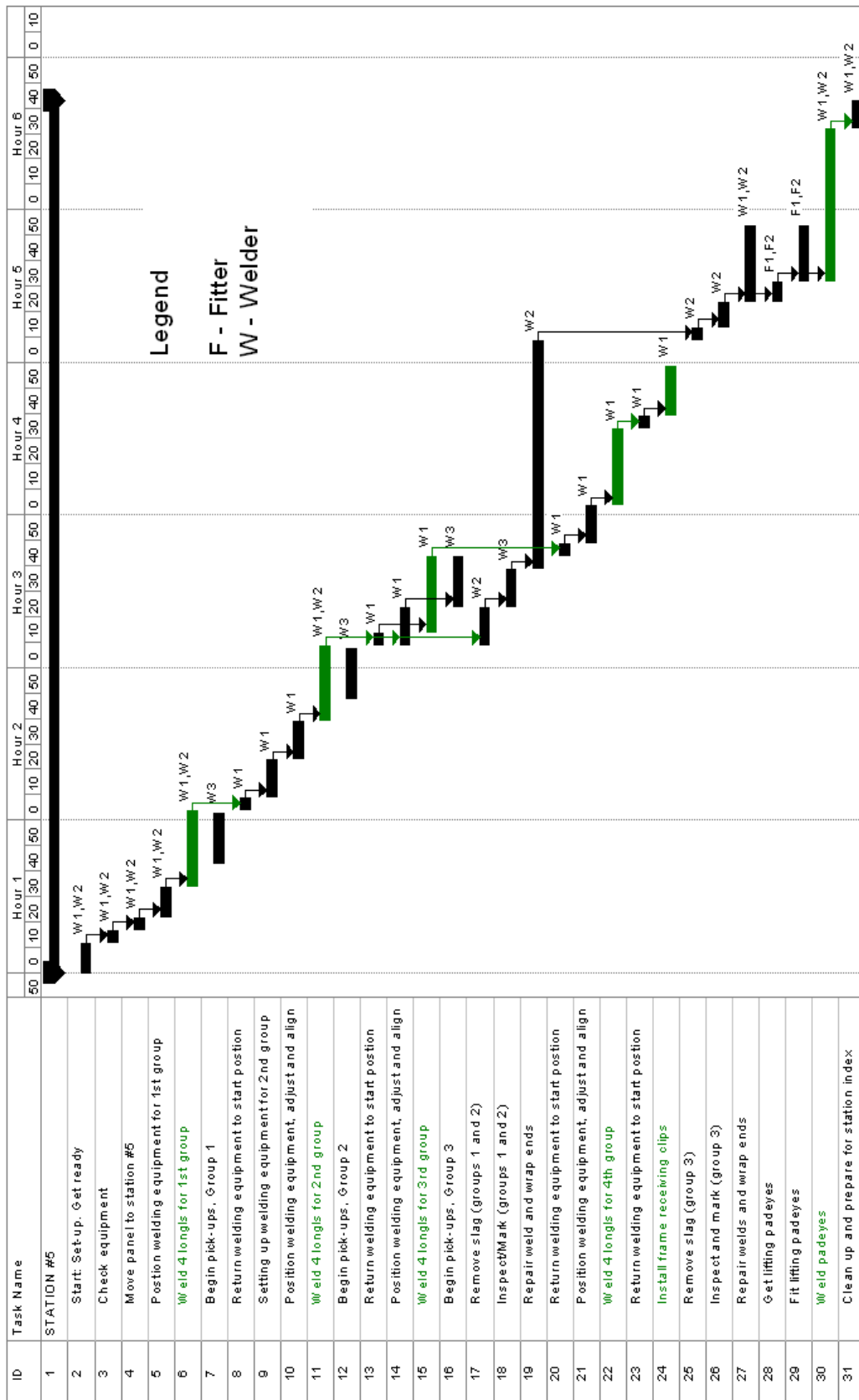


Fig. 4.23. Workstation 5 Gantt chart [2], [30]



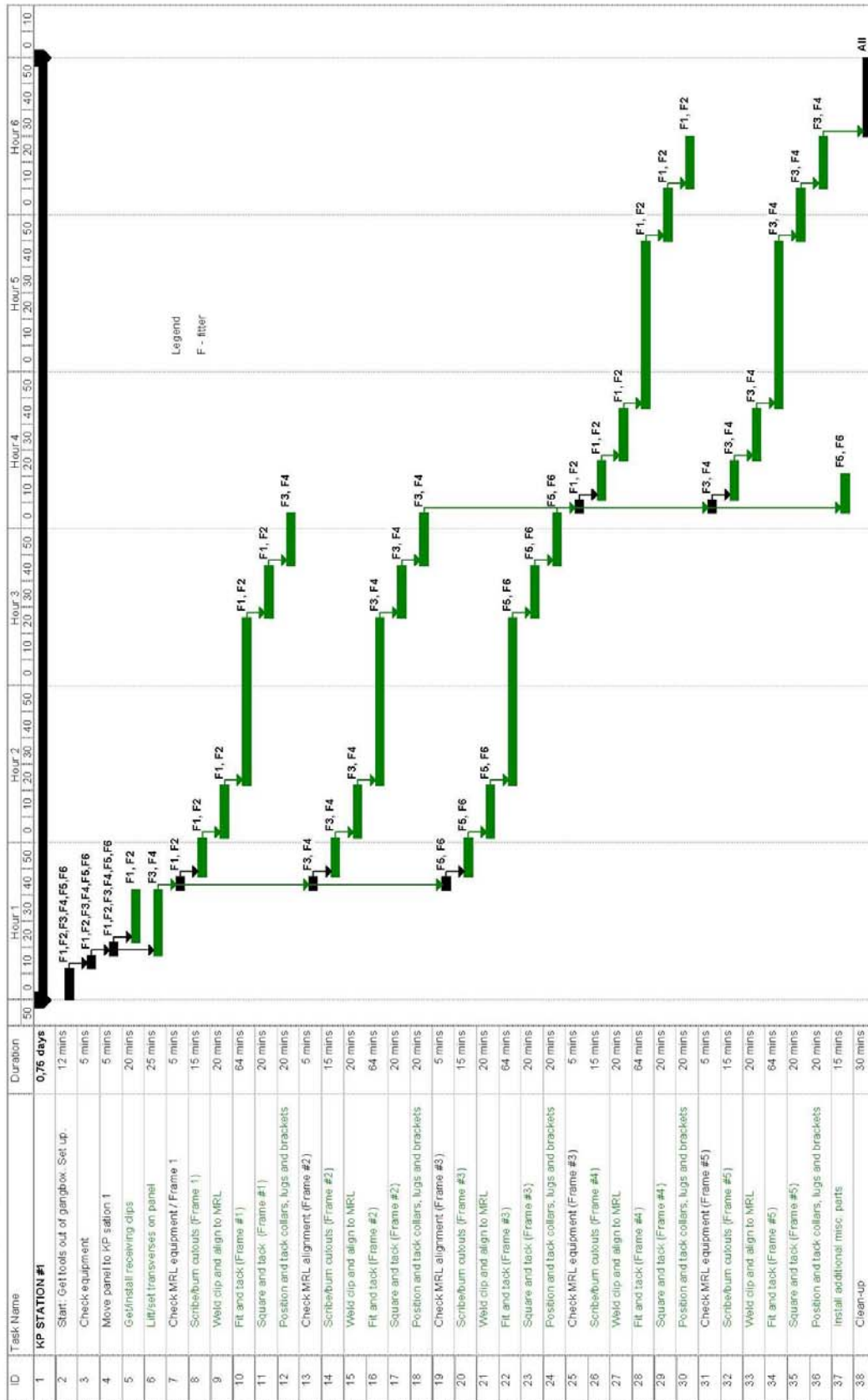


Fig. 4.24. KP Workstation 1 Gantt chart [2], [30]

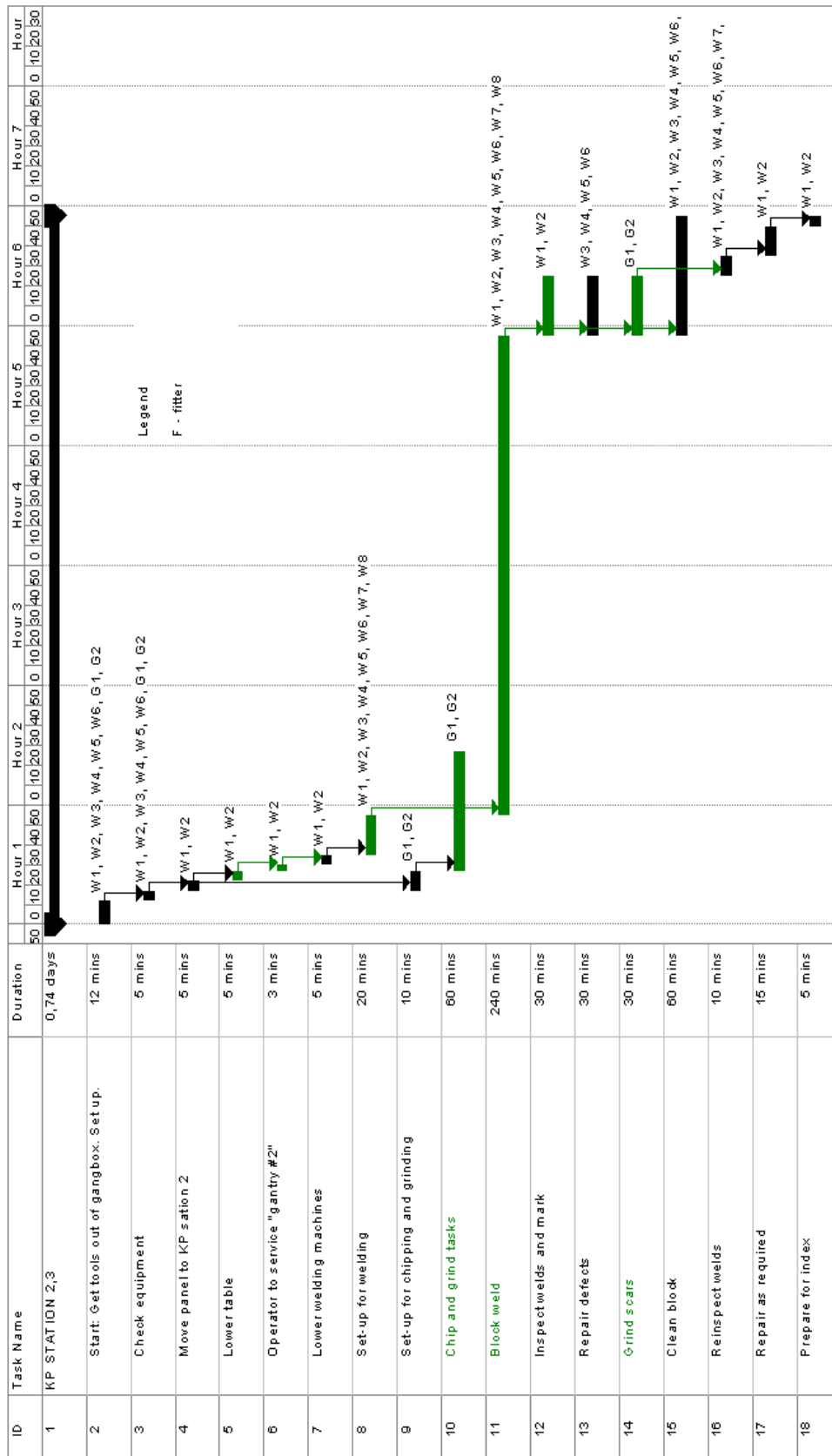


Fig. 4.25. KP Workstation 2 Gantt chart [2], [30]

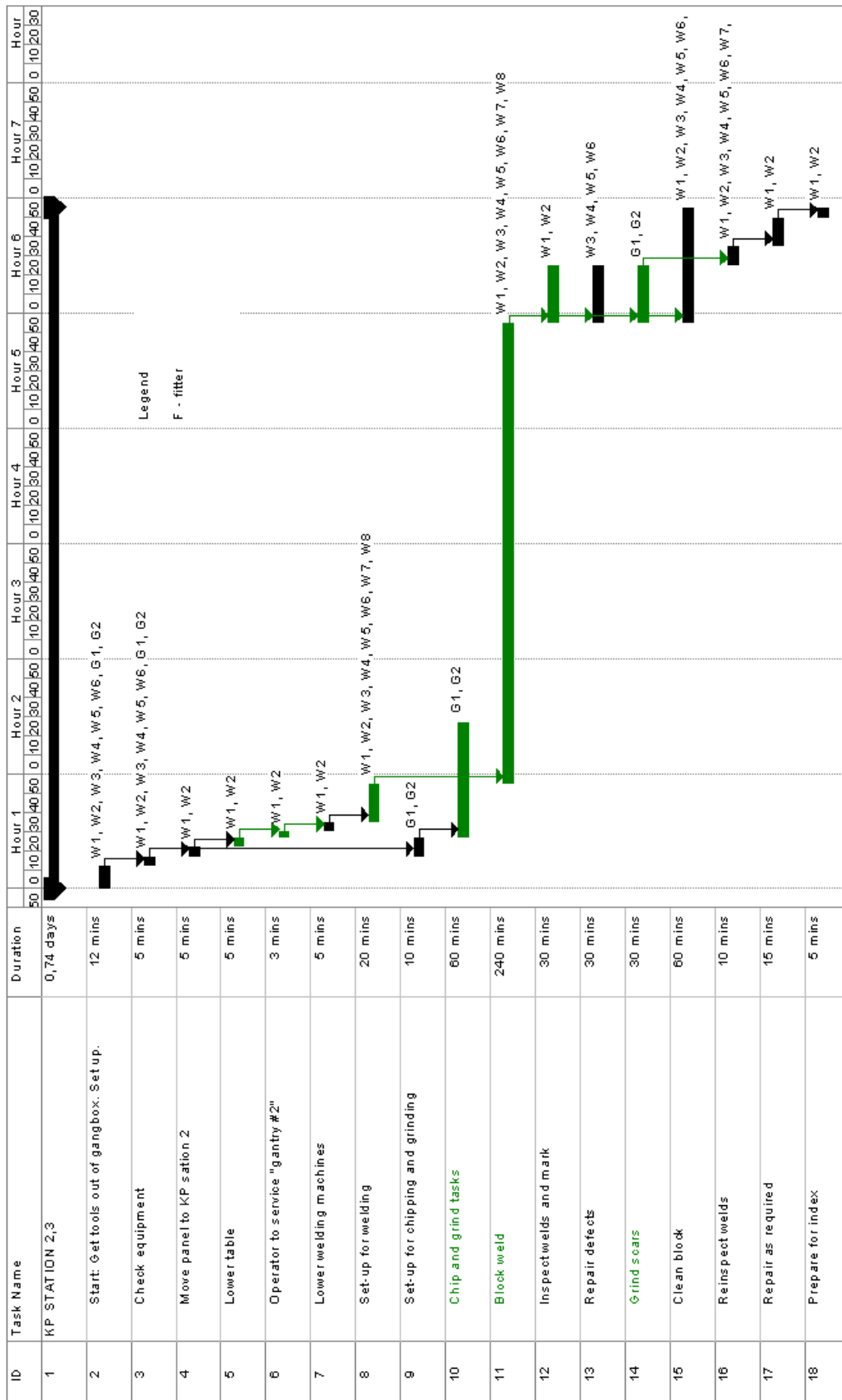


Fig. 4.26. KP Workstation 3 Gantt chart [2], [30]

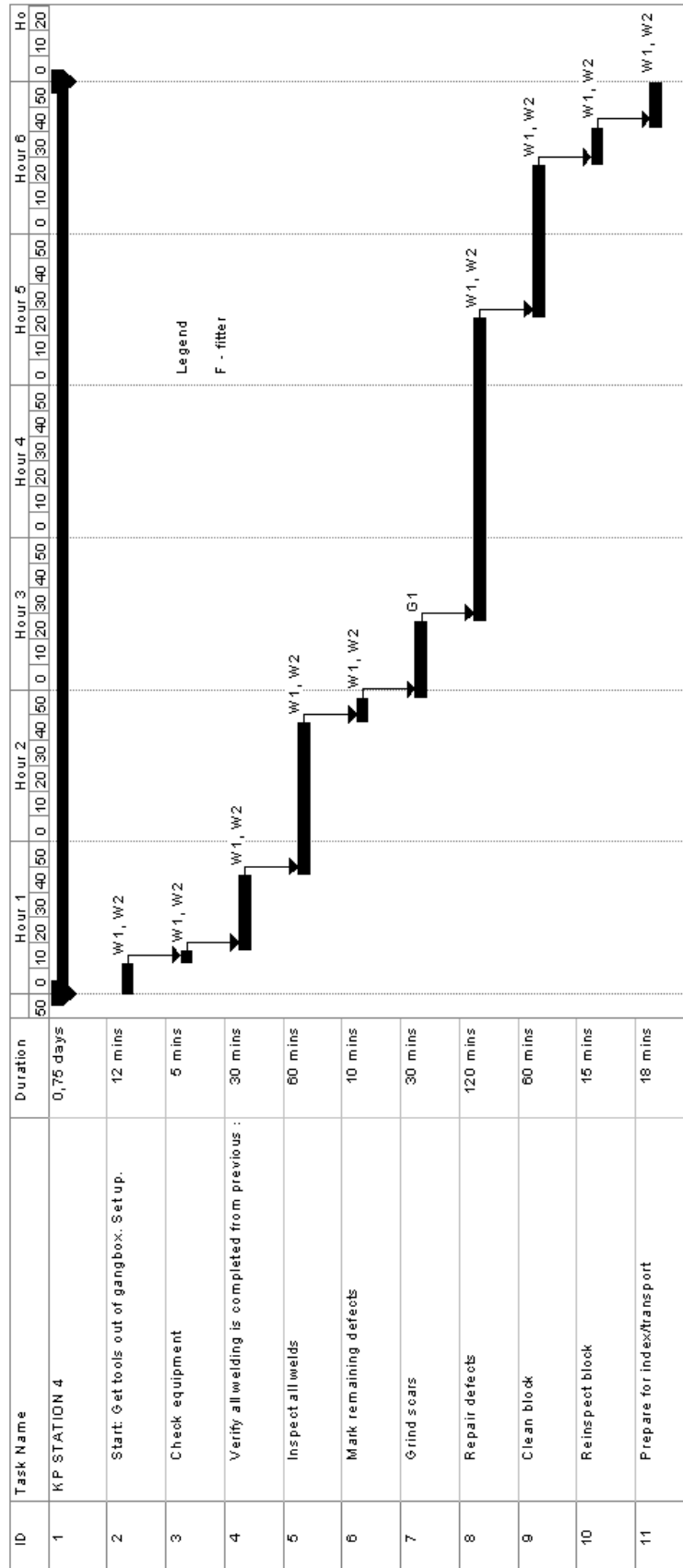


Fig. 4.27. KP Workstation 4 Gantt chart [2], [30]



#### 4.4. ANALYSIS OF THE TARGETED PRODUCTION PROCESS

The preceding figures 4.19–4.23 illustrate in detail the activities of assembling a typical panel for a chemical tanker, whereas figures 4.24–4.27 show the detailed activities for assembling the built-up panel from the same panel. The advantages of creating Gantt charts of interim family groups is that in this way production is expected to follow cycle times and complete the assembly of interim products in cycles. Detailed Gantt charts also allow a basis for further improvement, in other words to decrease the assembly cycle time, by identifying which activities can be improved, thereby making the process more efficient [2], [30], [37].

Whereas, it is important to create Gantt charts, it is also necessary to map the flow of interim products within a shipyard. Figures 4.28 to 4.30 illustrate the flow lines for the assembly of the double bottom block for the chemical tanker, car carrier, and crane barge respectively [30]. While the assembly lines follow a production logic based on the present configuration of the shipyard facilities, it is something which does not follow many of the principles of lean. There is much room for kaizen or improvement. The flow lines are cluttered and it appears that the value stream stream can be significantly improved. In Figure 4.28, assembly areas 5 and 6 and in Figure 4.29, assembly area 5 appear to be redundant, and unnecessary considering that the interim products (T-blocks) could be assembled using the panel line, KP line and finally assembled in assembly area 7. Figure 4.18 above showing the cluttered assembly hall “Cerovica C” clearly illustrates how the double bottom blocks are not made JIT and the pull principle is not followed because there are many interim products lying down and waiting to be sent to the slipway. The application of 5S in assembly area 7 (“Cerovica D”) of sorting, straightening, shining, standardizing and sustaining will allow a basis for for the implementation of lean manufacturing [27]. Likewise, the elimination of the 7 wastes which all exist includes overproduction, waiting, unnecessary motions, excessive transport, overprocessing, unnecessary inventory, and finally results in defects [3]. Figure 4.30 shows how the built-up panels are made on stationary workstations outside of the covered hall in area 4, while the blocks are assembled adjacently in area 5 which is also not protected. This means that the KP line is not utilized nor is the block assembly hall “Cerovica D” used. The reason for this is because the project for the crane barge was made by an external designer, who did not take into consideration DFP shipyard criteria, such as the height of built-up panels which are limited to 3.5 m, while the height of the built-up panels designed by the outside designer are higher [30].

One-piece flow is not practiced during the assembly of blocks either. Therefore, it is necessary to create a transformation of the shipyard facilities to comply with lean manufacturing.

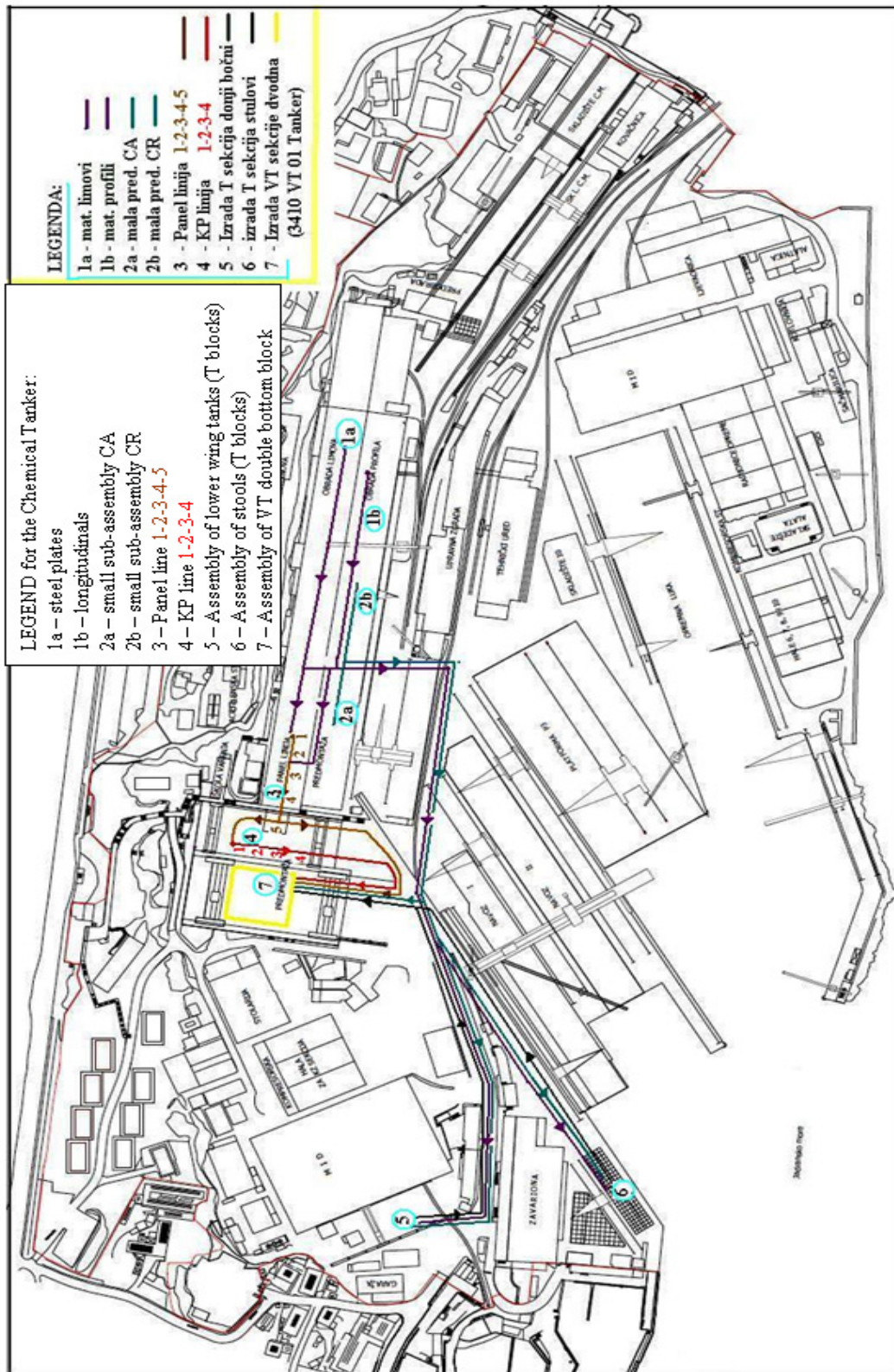


Fig. 4.28. Flow of material during the assembly of the double bottom block for the Chemical tanker in 3.Maj shipyard [30]



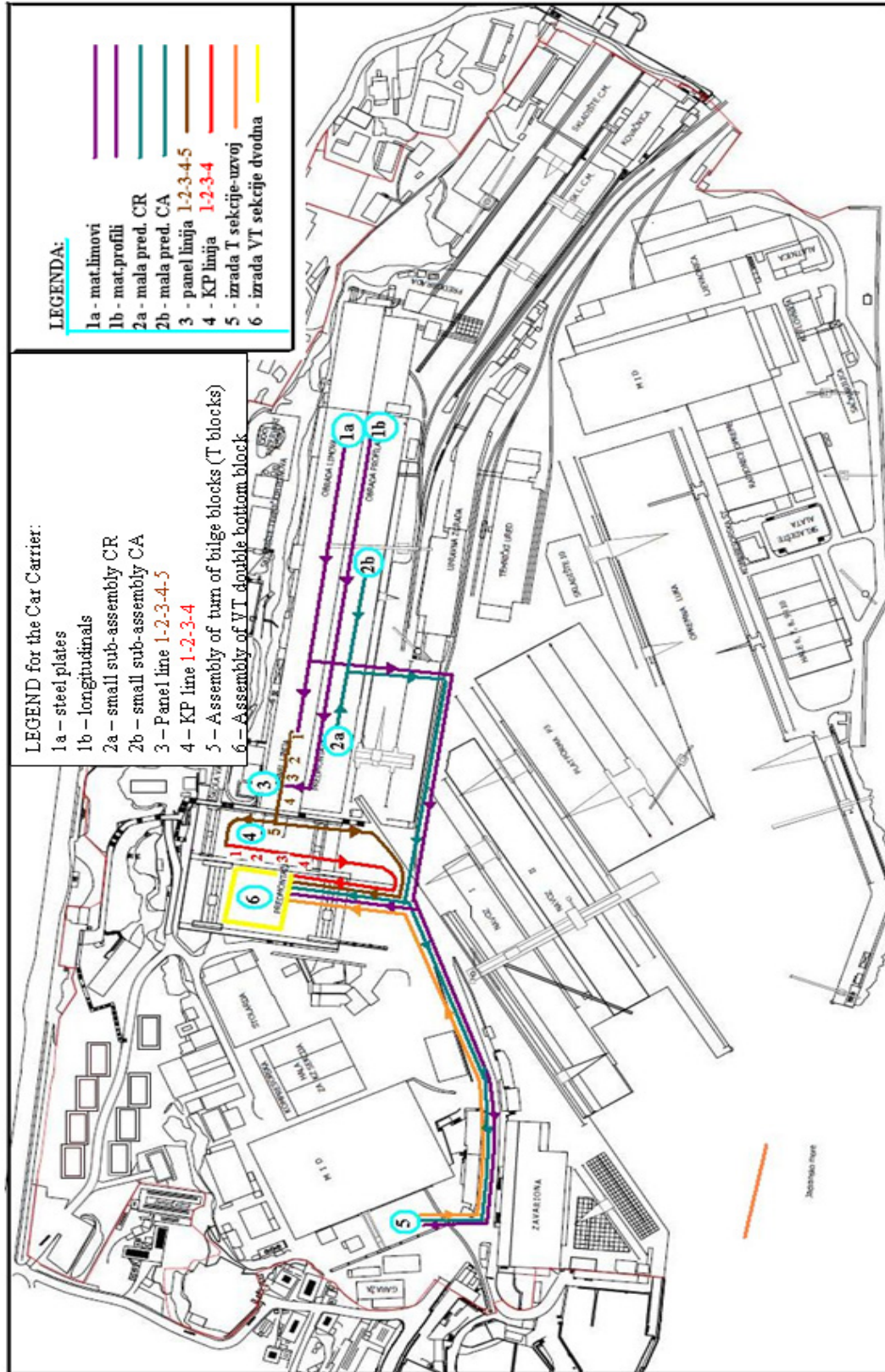


Fig. 4.29. Flow of material during the assembly of the double bottom block for the Car carrier in 3.Maj shipyard [30]



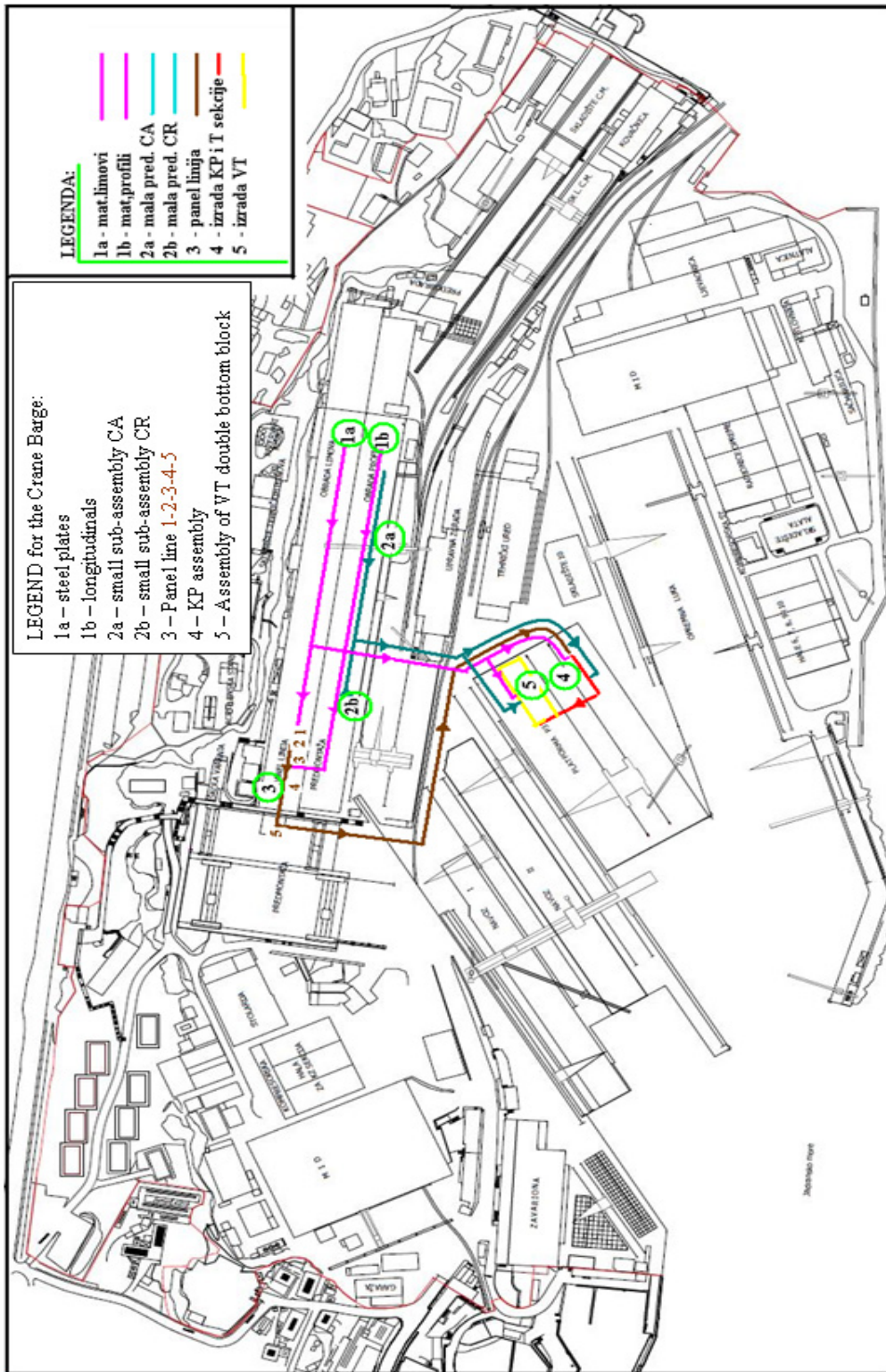
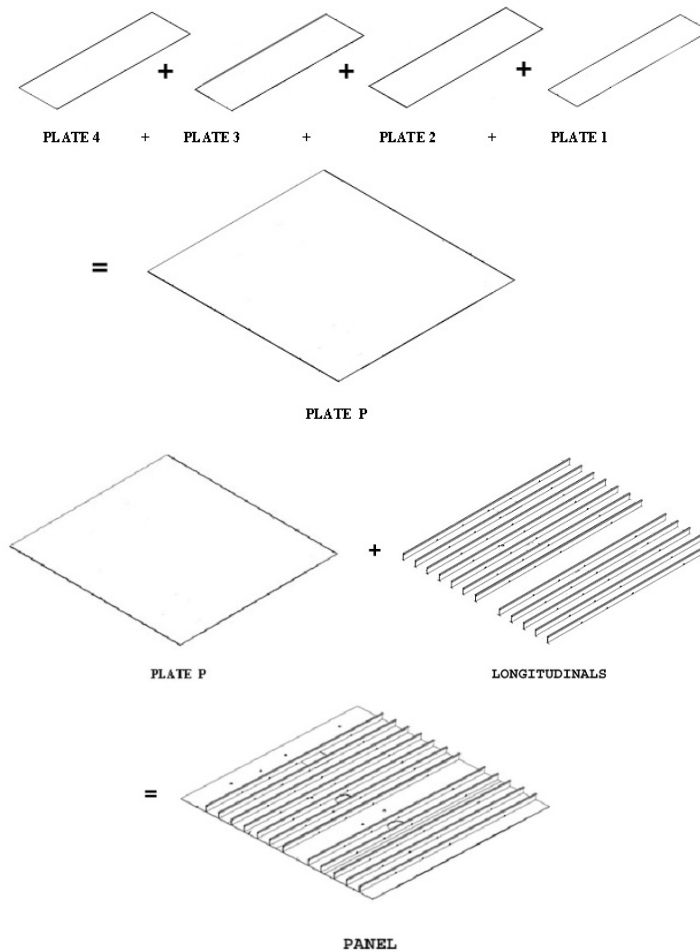


Fig. 4.30. Flow of material during the assembly of the double bottom block for the Crane barge in 3.Maj shipyard [30]

## 5. LEAN TRANSFORMATION

### 5.1. ASSEMBLY PRIOR TO LEAN TRANSFORMATION

From the case study in the previous section, it is clear that improvements made by simply using DFP techniques will not bring about drastic improvements in man-hours and duration time. Therefore the *lean transformation* methodology needs to be applied. Present day assembly sequence is illustrated in Figure 5.1:



**Fig. 5.1. Assembly sequence on the present panel line**

The algorithm for calculating man-hours for assembling interim products of the VT section:

$$\text{IPA time} = \sum_{i=1}^{i=m} P + \sum_{i=1}^{i=n} KP + \sum_{i=1}^{i=p} S + \sum_{i=1}^{i=q} T + \sum_{i=1}^{i=r} \text{Misc} \quad (5.1)$$

IPA time : All interim product assembly time.

**P**: panel; **m** is the number of panels in the VT section; **KP**: built up panels, **n** is the number of built up panels; **S**: sections, **p** is the number of sections; **T**: three dimensional sections; **q** is the number of three dimensional sections; Misc.: miscellaneous parts, **r** is the number of miscellaneous parts

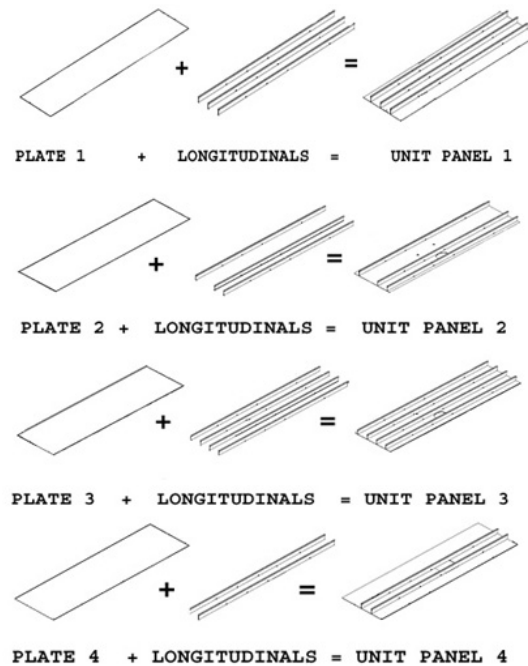
A practical method of summing up the assembly times is shown in the table below (Table 5.1).

**Tab. 5.1. Assembly time of interim products for the VT double bottom block [30]**

Interim product designation	Assembly time (man-hours)
P121	114
P221	104,5
P120	98
KP12	552
P220	104,5
KP22	592
S02	138
T02	213
S14	97
T12	98
S15	117,5
T14	189
S24	91
T22	98
S25	117,5
T24	189
M002VOD*2	17
<b>Sum</b>	<b>2930</b>

## 5.2. LEAN TRANSFORMATION PROCESS

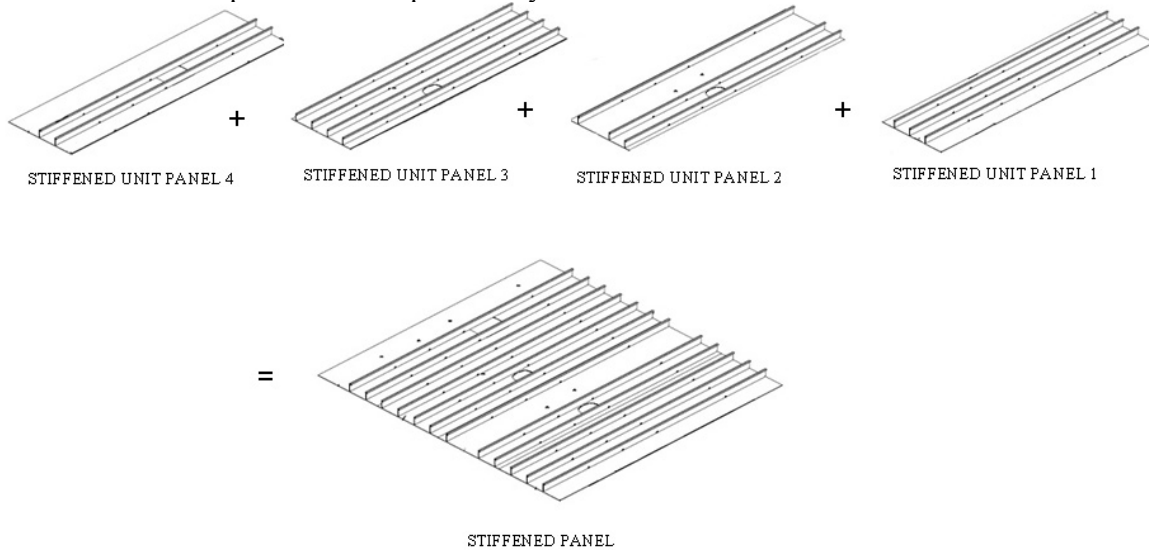
Lean transformation according to one piece flow of a typical double bottom block is illustrated in Figure 5.2 below.



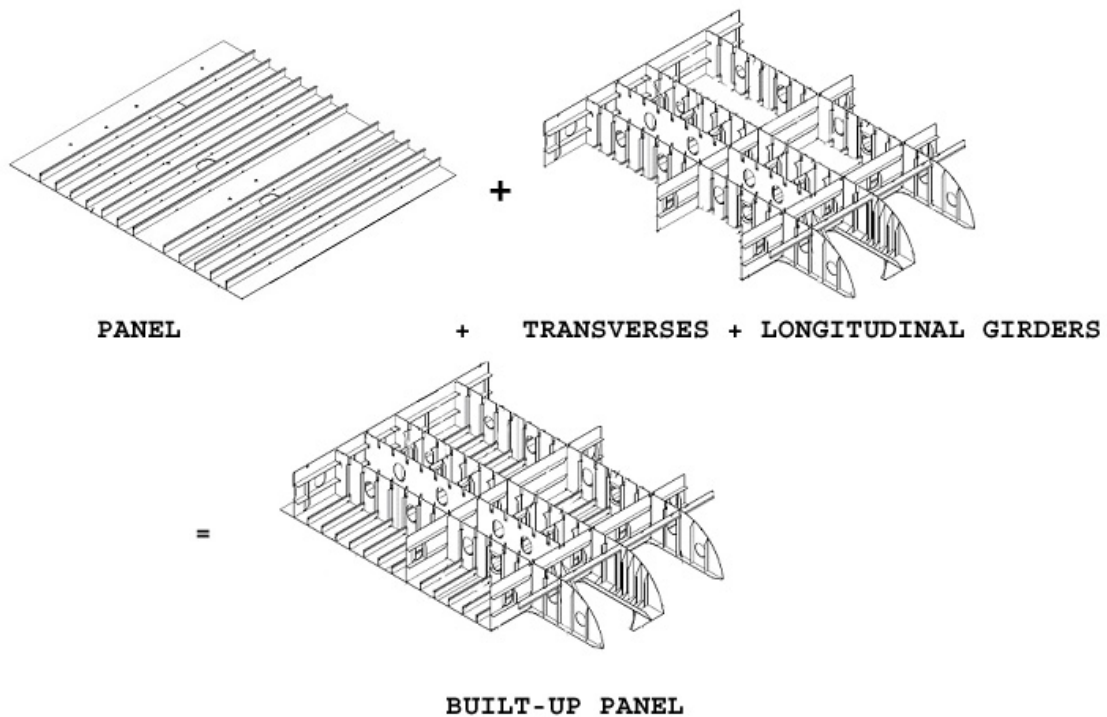
**Fig. 5.2. Assembly sequence on the Lean unit-panel assembly line**

The lean manufacturing principle of applying one-piece flow lends itself to a more productive and repetitive manufacturing task, where a smaller number of workers specially trained on an adjusted panel line do multiple tasks simultaneously. See Figures 5.3 to 5.4 below.

Once the four unit panels are completed they are then sent to the next station.



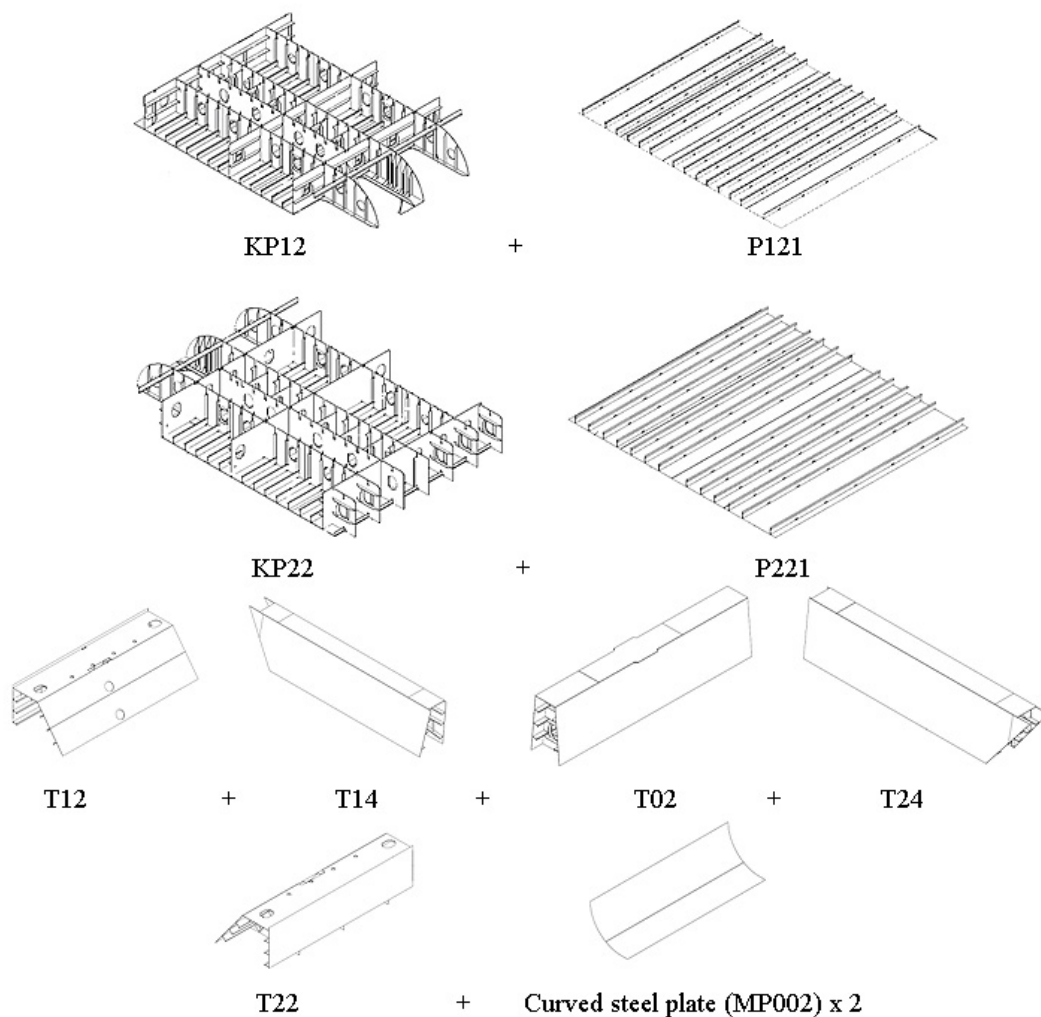
**Fig. 5.3. Assembly sequence on the Lean unit-panel assembly line continued**



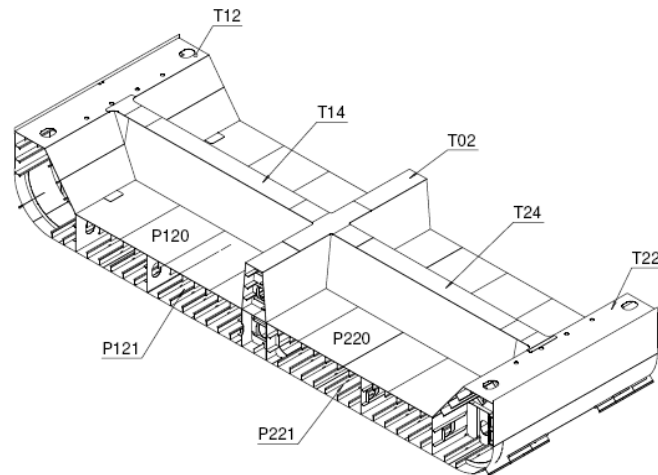
**Fig. 5.4. Assembly sequence on the Lean KP line**

Once the unit panels are welded together using Flux Copper Backing (FCB) welding technology at station 4 of the new transformed Lean panel line, the panel is then sent to the built-up panel (KP) assembly line. The transverses and the longitudinal girders are assembled separately off the KP line right after the micro-assembly line on a matrix jig. The egg-box like structure which can be seen on the top right picture of Figure 5.4 is then slid onto the panel through the slits which is to the left of the same figure above. This results in a drastic saving of time on the KP line since the IHOP and lean manufacturing principle of grouping is applied and not left to be assembled piece-meal as it is presently done in the shipyard. The result is a built-up panel assembled on two KP stations instead of four KP stations. The application of egg-box assembly off the KP line with the use of slits which integrates built-in quality.

The double bottom (VT) section consists of two built-up panels KP12 and KP22 plus another two panels P121 and P221 to form the bottom part of the entire double bottom block, plus two wing tanks designated as T12 and T22 (three dimensional sections), and the stool sections designated as T14, T02, and T24 (three dimensional sections), and finally two curved steel plates designated as MP002. See Figures 5.5 and 5.6 below.



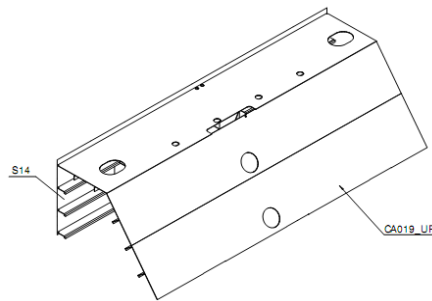
**Fig. 5.5. Interim products of the VT double bottom block [30]**



**Fig 5.6. The final double bottom block (very large three dimensional section) [30]**

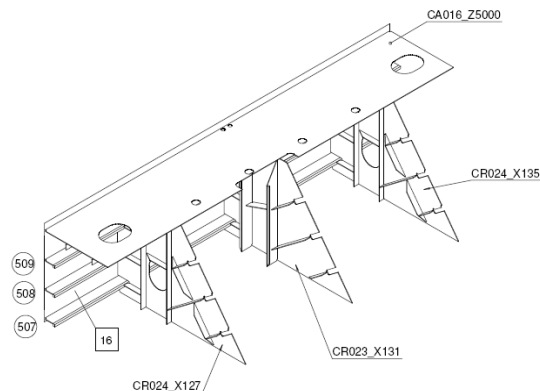
The wing tank designated T12 (Figure 5.7) consists of section S14, and other interim products from the micropanel and robot lines: CA019\_UP (6933 kg), CR025\_X129 (342,3kg) and miscellaneous plates (8,4+17,3+30,8=56,5 kg)

Section S14 (Figure 5.8) consists of steel plate with workshop marking #16 (3590kg) 3 HP profiles (580,3x3=1740,9kg), CA016\_Z5000(2197,1kg), CR024\_X135 (878,7kg), CR024\_X127 (878,7 kg), CR023\_X131 (1424,9kg).



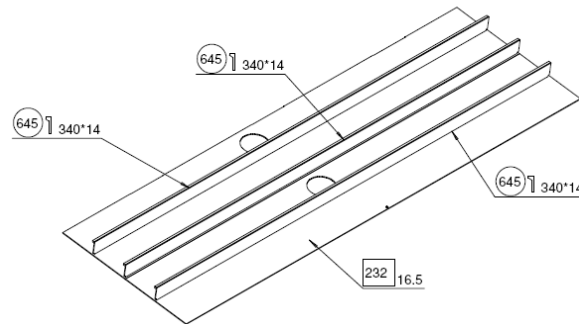
### T12

**Fig. 5.7. The port side wing tank designated T12 (three dimensional section) [30]**



**Fig. 5.8. Assembly of the section S14 which is an interim product of the lower wing tank T12 section of the VT section for the Chemical tanker [30]**

Using the transformed lean manufacturing workstation, the steel plate marked with workshop #16 (15mm thickness, 3590kg) and three profiles (workshop numbers 507-509) HP 340x14 L=11050 should be made on the lean unit panel line resulting in a unit panel which skips station 4 (FCB welding of unit panels) and is assembled on the KP line along with CR and CA elements + CA019, since  $S14 + CA019 = T12$ .



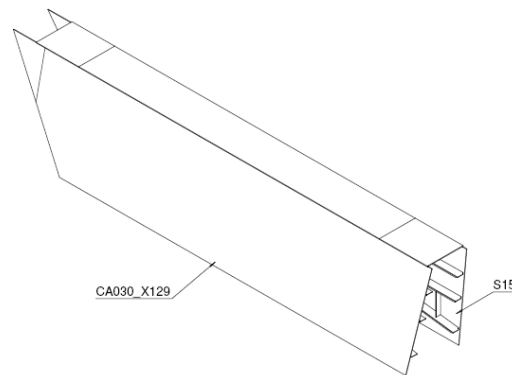
**CA019**

**Fig. 5.9. Assembly of the unit panel CA on the micropanel line which is an interim product of the lower wing tank T12 section of the Chemical tanker [30]**

The interim products of the T sections (stiffened panels) are presently assembled using static technology. However, with the transformed panel-block assembly line, the panels could be assembled along the automated panel line due to one piece flow being enabled.

Likewise  $T12 (18084 \text{ kg}) = T22 (18084 \text{ kg})$   
 $S14 (10752,6\text{kg}) = S24 (10752,6\text{kg})$

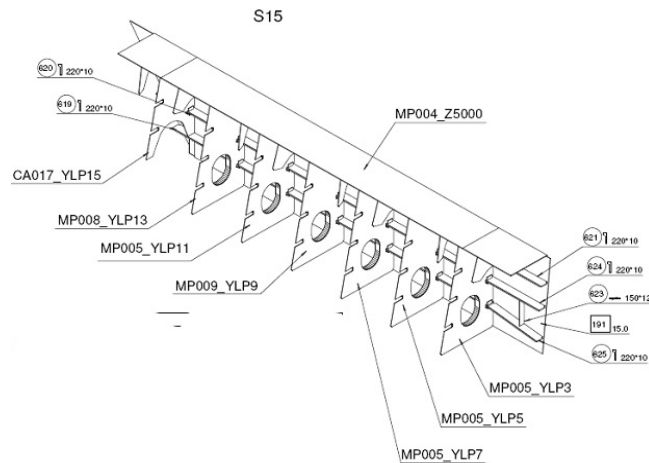
**Stool section T14 – (three dimensional section)**



**T14**

**Fig. 5.10. Stool section (T14) three dimensional section [30]**



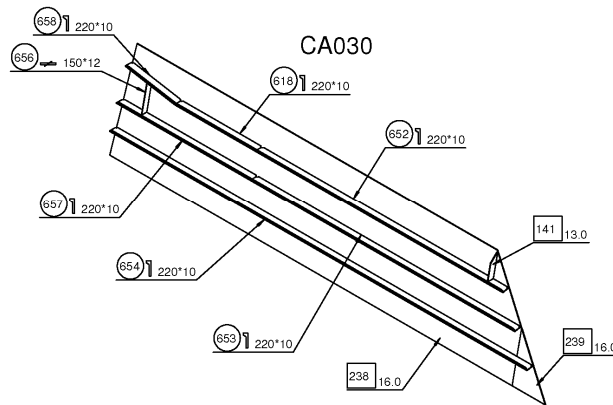


**Fig. 5.11. S15 interim product of the Stool section (T14) [30]**

T14 (Figure 5.10) section consists of S15 (10429,1kg) and CA030 (5406,1kg)

T24 consists of S25 (10429,1kg) and CA030 (5406,1kg)

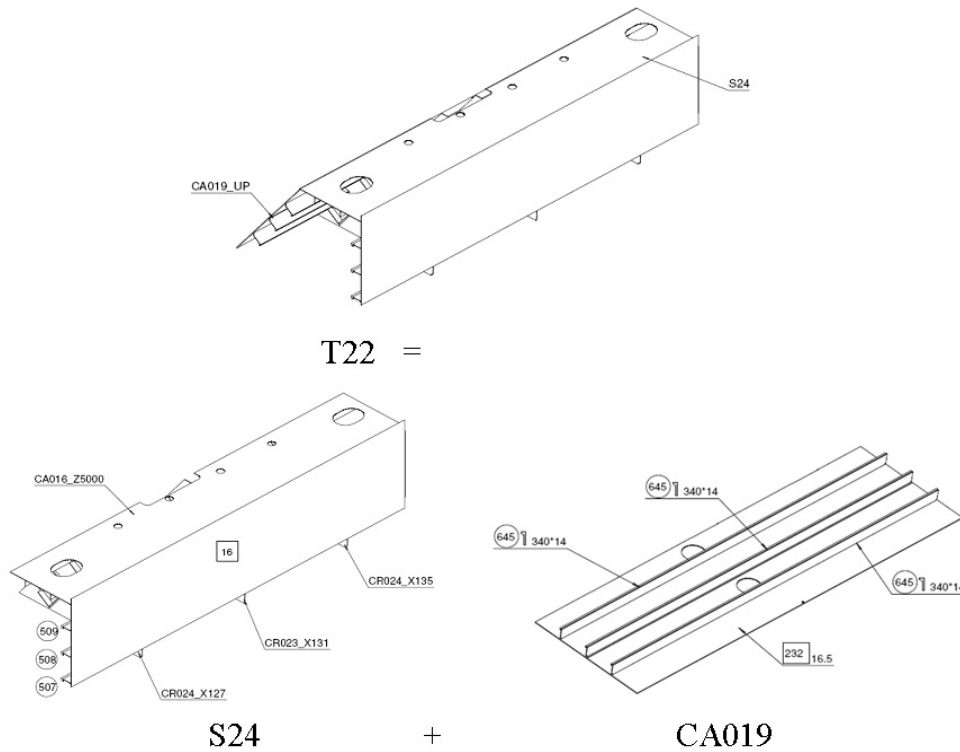
Same logic as with T12. S15 section (Figure 5.11) consists of unit panel with three longitudinals + transverse CA and MP elements and one longitudinal MP element, which could be assembled on the KP line. Then CA030 is assembled at Cerovica D to form T 14 section ready for assembly on the VT section. See Figure 5.12.



**Fig. 5.12. CA030 interim product of the Stool section (T14) [30]**

The other two sections T02 and T24 which comprise the other two sections that make up the stool of the VT double bottom section have similar type interim products as T14 and therefore will follow the same lean manufacturing philosophy. The other wing tank designated T22 (Figure 5.13) has a similar manufacturing method as described for the T12 wing tank above (Figures 5.7-5.9).





**Fig. 5.13. Starboard wing tank section designated T22 with interim products S24 and CA019 [30]**

**Tab. 5.2. Present day panel-block assembly workstations vs Lean transformation of panel block assembly workstations**

Present day panel-block assembly workstations [2], [30]		Lean transformation of panel block assembly workstations [10]	
Workstation	Description	Workstation	Description
1	Joining and welding of steel plates to form plate blanket	1	Edge trimming of skin plate
2	Plate blanket turned over and butt welded on the second side	2	Fitting of longitudinals on unit panel
3	Marking the plate blanket for longitudinal stiffeners, ultrasound control.	3	Welding of longitudinals
4	Fitting and welding of longitudinals	4	One sided butt welding (FCB)
5	Transporting to next built up line	5	Inserting of internal structure (egg-crate) with slots assembled on a matrix off workstation
6	Turning and levelling with heat	6	Welding of egg-crate by robots
7	Labelling, laying down, cutting and tack welding of transverses	7	Final three dimensional block assembly prior to erection on the slipway
8	Welding of transverses and cleaning the weld		
9	Fitting of ships equipment		
10	Final three dimensional block assembly prior to erection on the slipway		

The advantages of the lean transformation are that unit panels are useful for panels, built up panels, S-sections, where there are interim products with only one panel. The takt time is JIT. Tables 5.2 and 5.3 describe and illustrate the differences in assembling panels and built-up panels. The left column shows pictures of the workstations in the case study [30]. The right column shows pictures and sketches of the lean workstations in IHI shipyard which are most likely one of the few shipyards in the world that comes closest to *lean manufacturing* [10].




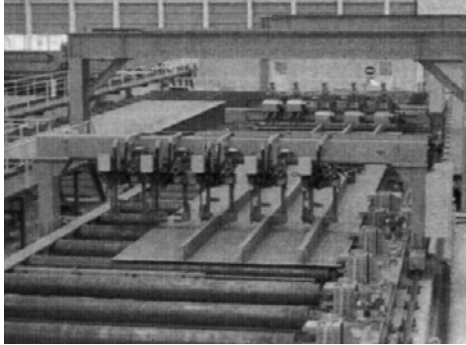

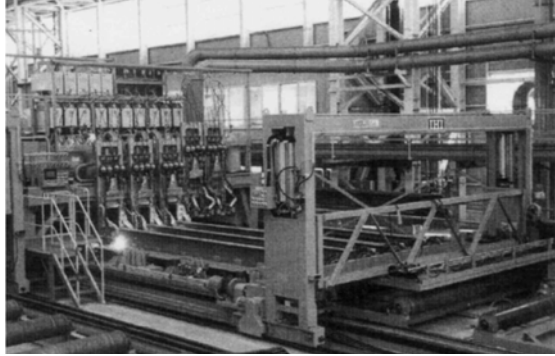

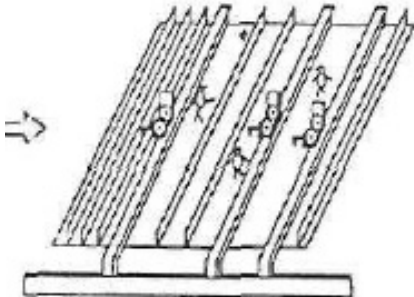
### **Additional technological tools and equipment necessary for the lean transformation of 3.Maj shipyard**

The additional technological tools necessary for the lean transformation of the 3.Maj panel-block assembly workstations shown in Table 5.2 above are as follows:


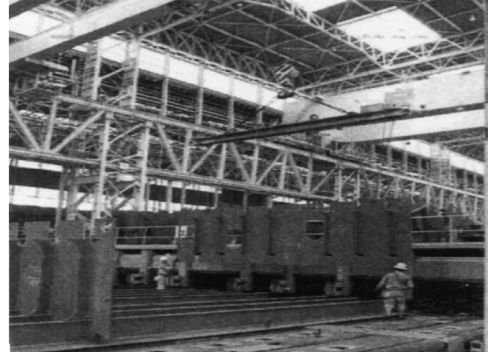

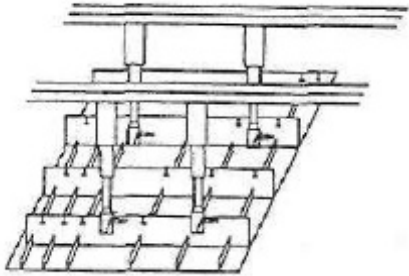



- High-grade fitting machine for fitting up to 4 longitudinals at lean workstation 2 in table 5.2 and 5.3,
- Automatic welding machines (4 pieces) on girder for welding longitudinals on both sides simultaneously at lean workstation 3 in table 5.2 and 5.3,
- One side automatic Flux-Copper Backing (FCB) x 4 machines at lean workstation 4 in table 5.2 and 5.3,
- Pushing type insert equipment at lean workstation 5 in table 5.2 and 5.3,
- Portable welding robots (4 pieces) which are hung down from two girders at lean workstation 6 in table 5.2 and 5.3.
- 3.Maj shipyard possesses other equipment to cover the lean technology transformation requirements

The present panel line is located in a space with an area of 1350 m<sup>2</sup> (25m x 65m) whereas for the lean transformation 1035 m<sup>2</sup> satisfies the needs for lean transformation of the workstations [30]. With the lean transformation, the first three workstations take up 315 m<sup>2</sup> since there is unit flow, which means that steel plates up to 3 m in width are applied and fitted with longitudinals [4], [10]. Only in the one-sided FCB welding process in lean workstation 4 is the width of the lean panel line the same as is in the present day panel line [4], [30]. There is also no need for turning due to one-sided FCB welding which essentially eliminated the space taken up by lean workstation 2 [4], [10]. The extra space is open for the addition of another 3 lean workstations in case the production program needs of the shipyard increase in the future. In general lean transformation requires no additional space [3]. The production processes after block assembly of 3.Maj shipyard are technologically able to handle the interim products (double bottom blocks, wing tanks). This includes anti-corrosive protection and erection on the slipway (See Figure 5.21).

**Tab. 5.3. Illustration of present day workstations vs. Lean transformed workstations**





Present day workstations	Lean transformation
 <p data-bbox="207 688 764 716">Workstation 1: Butt welding of plates on first side [30].</p>	 <p data-bbox="797 674 1159 701">Workstation 1: unit plate flowing [3]</p>
 <p data-bbox="207 1073 769 1125">Workstation 2: Turning over plate bed and butt welding of the second side [30].</p>	 <p data-bbox="797 1062 1313 1115">Workstation 2: Fitting of longitudinals on unit plate [4].</p>
 <p data-bbox="220 1486 756 1541">Transport to workstation 3 where bed plate is marked [30]</p>	 <p data-bbox="797 1482 1248 1509">Workstation 3 : Welding of longitudinals [4].</p>
 <p data-bbox="263 1875 712 1902">Workstation 4: Placing of longitudinals [30].</p>	 <p data-bbox="797 1860 1321 1913">Workstation 4: One sided butt welding of unit panels (FCB) [4].</p>

**Tab. 5.3. Illustration of present day workstations vs. Lean transformed workstations continued**

Present day workstations	Lean transformation
 <p data-bbox="277 741 820 800">Workstation 4: Double sided fillet welding of longitudinals [30].</p>	 <p data-bbox="872 741 1356 800">Workstation 5: Inserting of transverse webs by sliding through slits [4].</p>
 <p data-bbox="329 1140 802 1167">Workstation 5: Transport of stiffened panel [30].</p>	 <p data-bbox="951 1125 1338 1155">Workstation 6: Welding by robots [4].</p>
 <p data-bbox="277 1486 849 1516">KP Workstation 1: Receiving stiffened panels [30].</p>	 <p data-bbox="872 1509 1362 1539">Assembly of block in assembly hall [3].</p>
 <p data-bbox="342 1898 794 1927">KP Workstation 2: Turning and levelling [30].</p>	



**Tab. 5.3.** Illustration of present day workstations vs. Lean transformed workstations continued.

Present day workstations	Lean transformation
 <p data-bbox="269 716 719 743">KP Workstation 2: Turning and levelling [30].</p>	
 <p data-bbox="207 1087 724 1119">KP Workstation 3: Fitting of internal structure [30].</p>	
 <p data-bbox="207 1457 743 1486">KP Workstation 4: Welding of internal structure [30].</p>	
 <p data-bbox="207 1881 643 1904">Final Assembly of all interim products [30]</p>	

The transformed lean workstation Gantt charts below (Figures 5.14-5.19) were developed from the Gantt charts of the case study through the use of lean Gantt chart techniques. The activities labelled in green color represent the added value activities, whereas the black are necessary non-added value activities. The duration time per workstation has decreased to two hours. The use of the unit panel slit method along with adjusted facilities enables a smaller number of workers to perform the same task due to the improved technology and methodology. This is also evident from the Lean workstation Gantt charts. There is maximum use of automation and robotization along the lines which is another requirement for the maintenance of takt time and JIT flow [3], [41]. The panels and the built-up panels as a result are assembled with smaller duration time as well as fewer man-hours. Please note that the activities with green font text and bars indicate value added activities (tacking, welding, burning, grinding, adding parts), whereas the other activities in black font and black bars indicate non-value added activities (setting up, transport, loading, moving, checking equipment, cleaning).

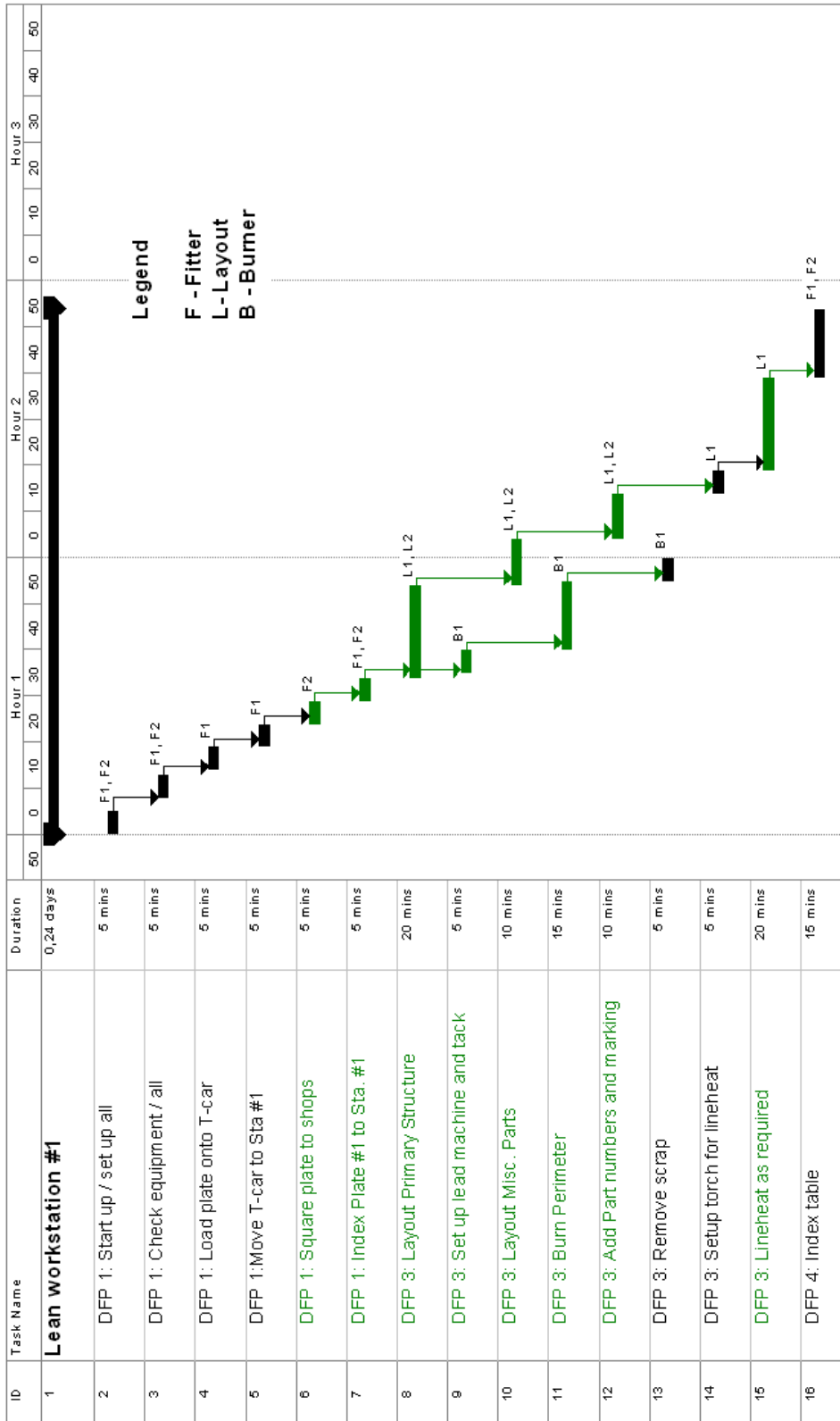


Fig. 5.14. Lean Workstation 1 Gantt chart

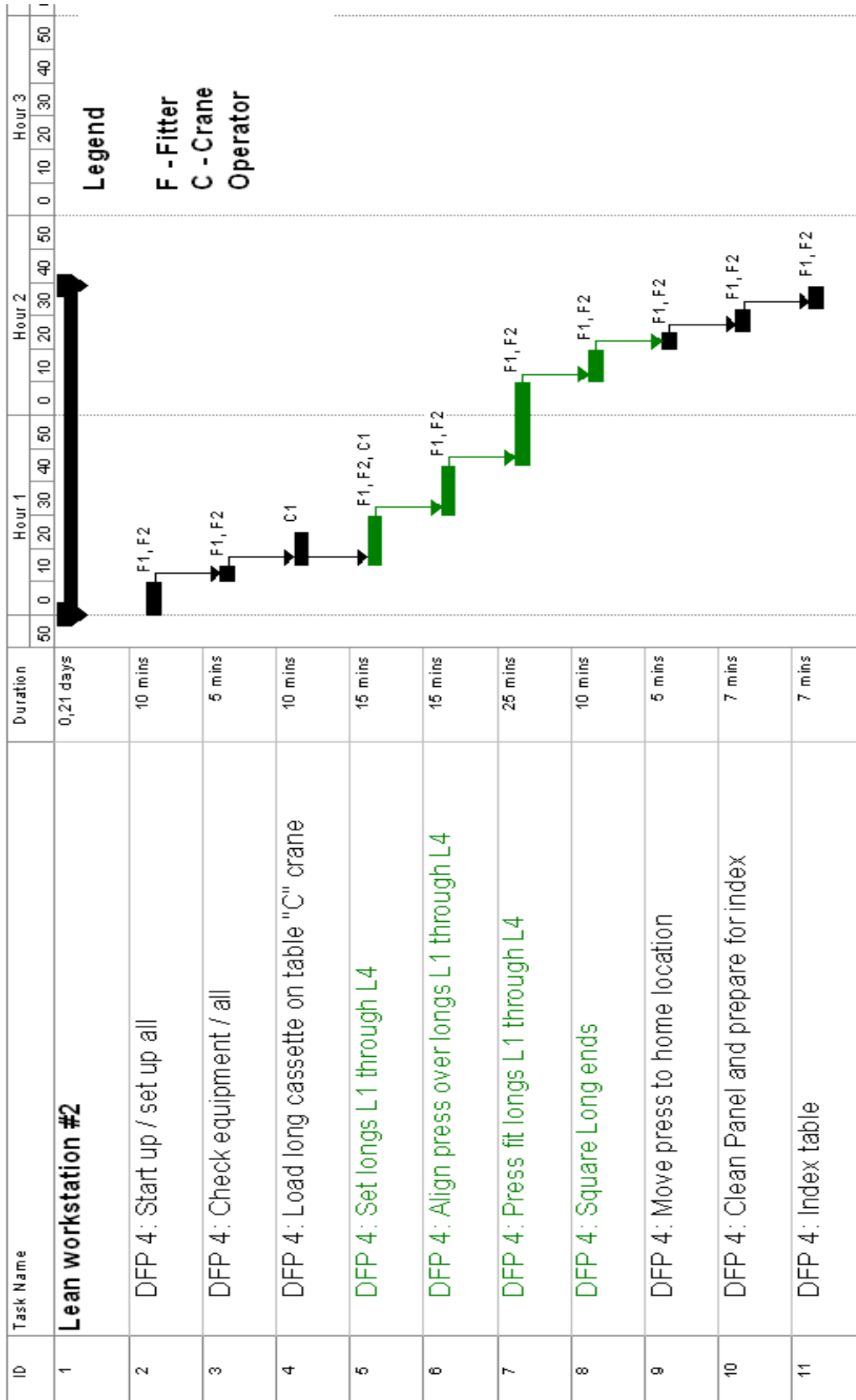


Fig. 5.15. Lean Workstation 2 Gantt chart



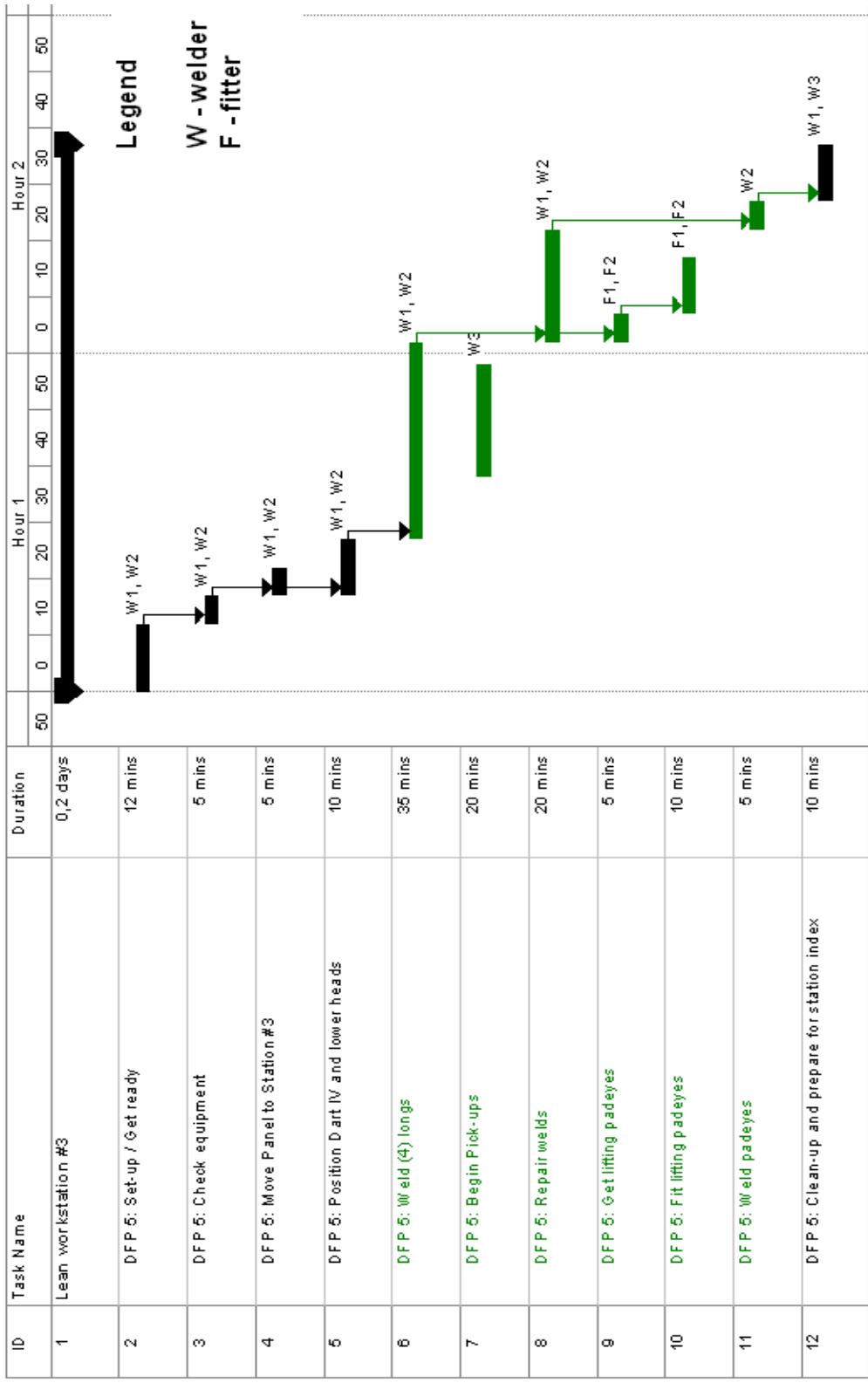


Fig. 5.16. Lean Workstation 3 Gantt chart

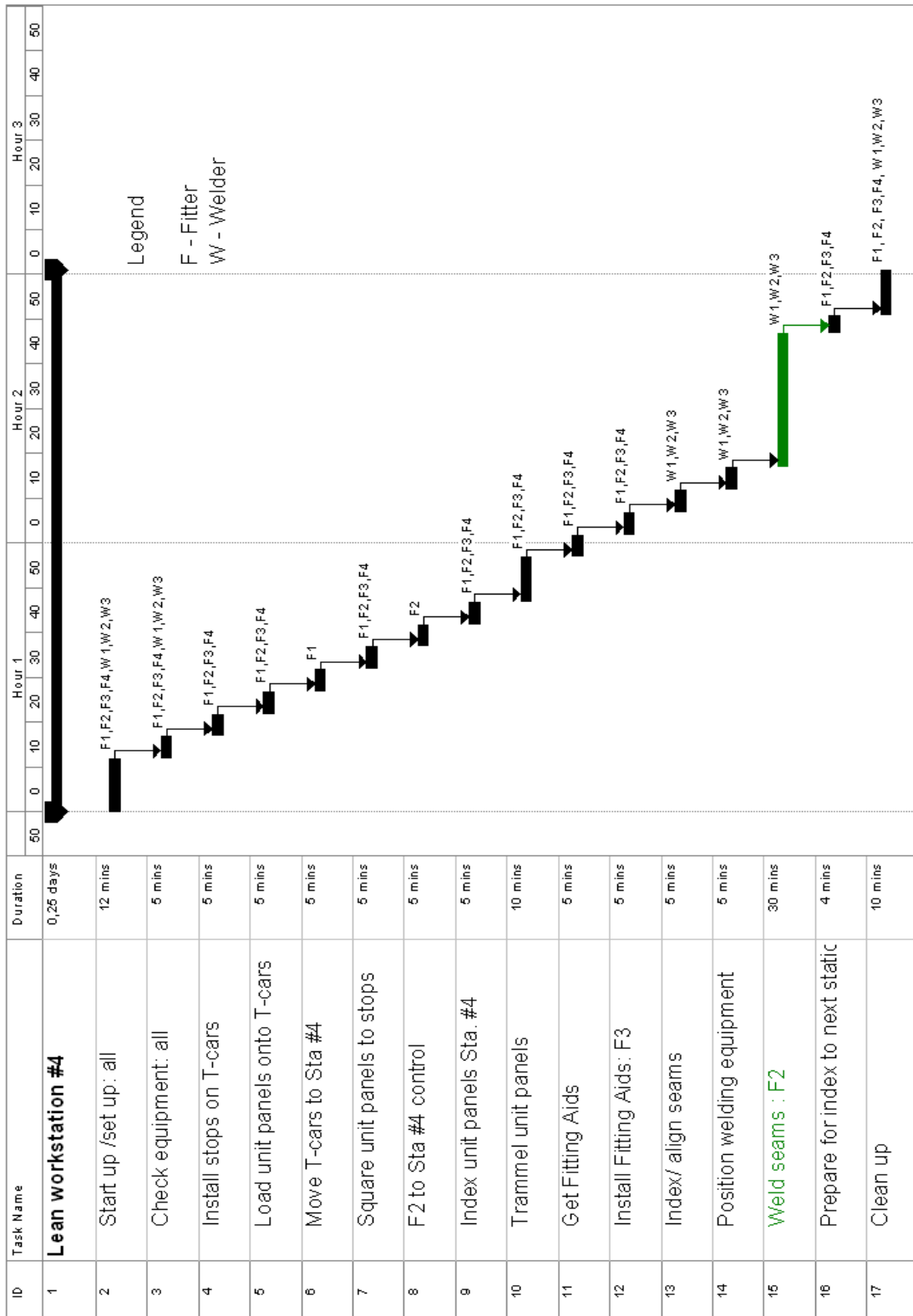


Fig. 5.17. Lean Workstation 4 Gantt chart



Fig. 5.18. Lean KP Workstation 1 Gantt chart

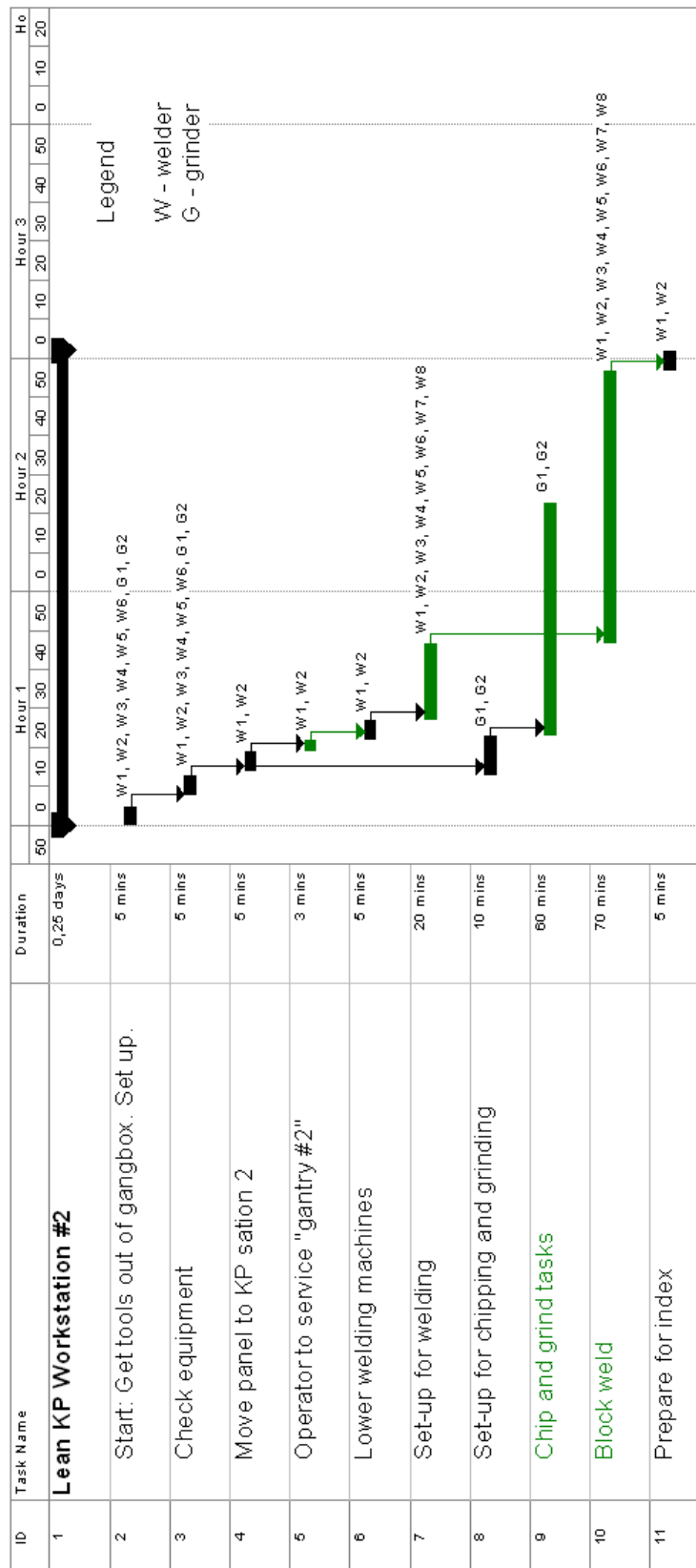


Fig. 5.19. Lean KP Workstation 2 Gantt chart

Table 5.4 below shows a list of man-hours for the present day panel line which is 114 man-hours; the unit-panel assembly which is 8 hours, and the the lean panel assembly which is 45,6 man-hours. Table 5.5 shows the man-hours for the present day built-up panel line which is 552 man-hours and the man-hours for the lean transformed built-up panel line of 221 man-hours. The lean assembly processes result in savings of 60% over the present day shipyard assembly processes.

**Tab. 5.4. Man-hours comparison for unit panel assembly of P121 for the Chemical tanker**

Trades	Present assembly man-hours	Unit panel man-hours	Lean panel assembly man-hours
Ship fitters	11	1	8,6
Welders	25	1	7,5
Automaters	43,5	2	7,5
Markers	7,1	1	5,5
Cutters	5,1	1	5,5
Levelers	10,3	1	5,5
Grinders	12	1	5,5
<b>Total</b>	<b>114</b>	<b>8</b>	<b>45,6</b>

**Tab. 5.5. Lean transformation man-hours for assembling a built-up panel KP12 for the Chemical tanker.**

Trades	Present day built-up panel assembly (man-hours)	Lean built-up panel assembly (man-hours)
Ship fitters	129	57
Welders	324	137
Markers	6	4
Grinders	81	20
Levelers	10	5
Groovers	2	1
<b>TOTAL</b>	<b>552</b>	<b>221</b>

The total assembly time of the interim products through the lean transformed shipyard assembly processes can be calculated according to the following equation:

$$\text{Lean IPA time} = C_P * \sum_{i=1}^{i=m} P + C_{KP} * \sum_{i=1}^{i=n} KP + C_S * \sum_{i=1}^{i=p} S + C_T * \sum_{i=1}^{i=q} T + C_{Misc} * \sum_{i=1}^{i=r} \text{Misc} \quad (5.2)$$

IPA time: Interim products assembly time;  $C_P$ : Lean panel assembly transformation time coefficient;

$C_{KP}$ : Lean built-up panel assembly transformation time coefficient;  $C_S$ : Lean section assembly transformation time coefficient;  $C_T$ : Lean three-dimensional assembly transformation coefficient

$C_M$ : Lean miscellaneous product transformation coefficient

The following table lists the assembly man-hours, lean transformation coefficients and the Lean interim products assembly (IPA) time for all the interim products of the double bottom block VT02, Group 3410 for the chemical tanker (See Table 5.6). The Lean IPA time is calculated as in equation 5.2 above and yields a value of 1182 man-hours, which is a savings

of 60%. The savings for assembling interim products of the VT section using lean transformation are 60% in comparison to the present day assembly methods of 2930 hours.

**Tab. 5.6. Interim products assembly times in hours**

Interim product designation	Present-day assembly time (hrs)	Lean Transformation Coefficients	Lean assembly time (hrs)
P121	114	0,4	45,6
P221	104,5	0,4	41,8
P120	98	0,4	39,2
KP12	552	0,4	220,8
P220	104,5	0,4	41,8
KP22	592	0,4	236,8
S02	138	0,4	55,2
T02	213	0,4	85,2
S14	97	0,4	38,8
T12	98	0,4	39,2
S15	117,5	0,4	47
T14	189	0,4	75,6
S24	91	0,4	36,4
T22	98	0,4	39,2
S25	117,5	0,4	47
T24	189	0,4	75,6
M002VOD*2	17	1	17
<b>Sum</b>	<b>2930</b>		<b>1182</b>

The type plan for the *lean manufacturing* block assembly is developed in Figure 5.20 below. It illustrates the assembly method with slots and the elimination of lugs in the first column on the left. The possible risk areas column lists the needs for improving technology in the lean transformation through the use of advanced welding and robotic systems. The general improvements column describes the technologies that will need to be introduced for a lean transformation. Finally, the performance improvement initiatives column is in compliance to *kaizen*, or continual improvement, and lists steps necessary for further improvement of the process upon lean transformation of the shipyard facilities.

Likewise the *lean manufacturing* transformation of flow lines is shown in Figure 5.21 below. Please note that the transformed flow line of interim products for block assembly are significantly improved when compared to the present state interim product flow lines from the DFP case study (See Figures 4.28 to 4.30). The transformed *lean manufacturing* work stations and technology along with one-piece flow in block assembly creates a more factory like assembly process, which results in a reduction of man-hours, as well as saving spacing and eliminating peripheral assembly sites for the wing tanks and stool sections.

Lean Assembly Method	Possible Risk Areas	General Improvements	Performance Improvement Initiatives
<p>Step 1: Fully weld longitudinals to the first plate blanket</p> <p>Step 2: Slide webs over longitudinals and fully weld</p> <p>Step 3: Fully weld longitudinals to second plate blanket</p> <p>Step 4: Turn second plate panel onto first built up panel and slide panel longitudinals through the slots</p>	<p>1. This method requires maximum levels of precision and advanced welding and robot systems.</p> <p>2. Major investment in advanced shipbuilding automation technology.</p>	<p>1. Transformation of the traditional large panel line for unit panel assembly.</p> <p>2. Introduction of one-side automatic welding – Flux-Copper Backing (FCB) machines and high grade cutting machines are required. [10]</p> <p>3. Pushing type equipment [10].</p> <p>4. The transverse webs “are automatically welded by portable welding robots which are hung down from a girder” [10].</p> <p>5. “The merits of this <i>unit-panel &amp; slit process</i> are as follows” [10]:          “The unit-panel technique can be applied for almost all of main structures – shell, bulkhead, deck, etc., of all kinds of ships – tankers, bulk carriers, container ships, etc. Therefore, manufacturing facilities newly introduced are widely accepted” [10].</p>	<p>Maximize the use of the lean block assembly method          Productivity versus Technology          Value added / Non value added work. [2], [25]</p> <ol style="list-style-type: none"> <li>1. Identify non value added work and reduce,</li> <li>2. Apply manufacturing value analysis technique.</li> <li>3. Identify rework and reduce.</li> <li>4. Identify bottlenecks and eliminate.</li> </ol>

Fig. 5.20. Typical block assembly type action plan for Lean future state [2], [10], [25]

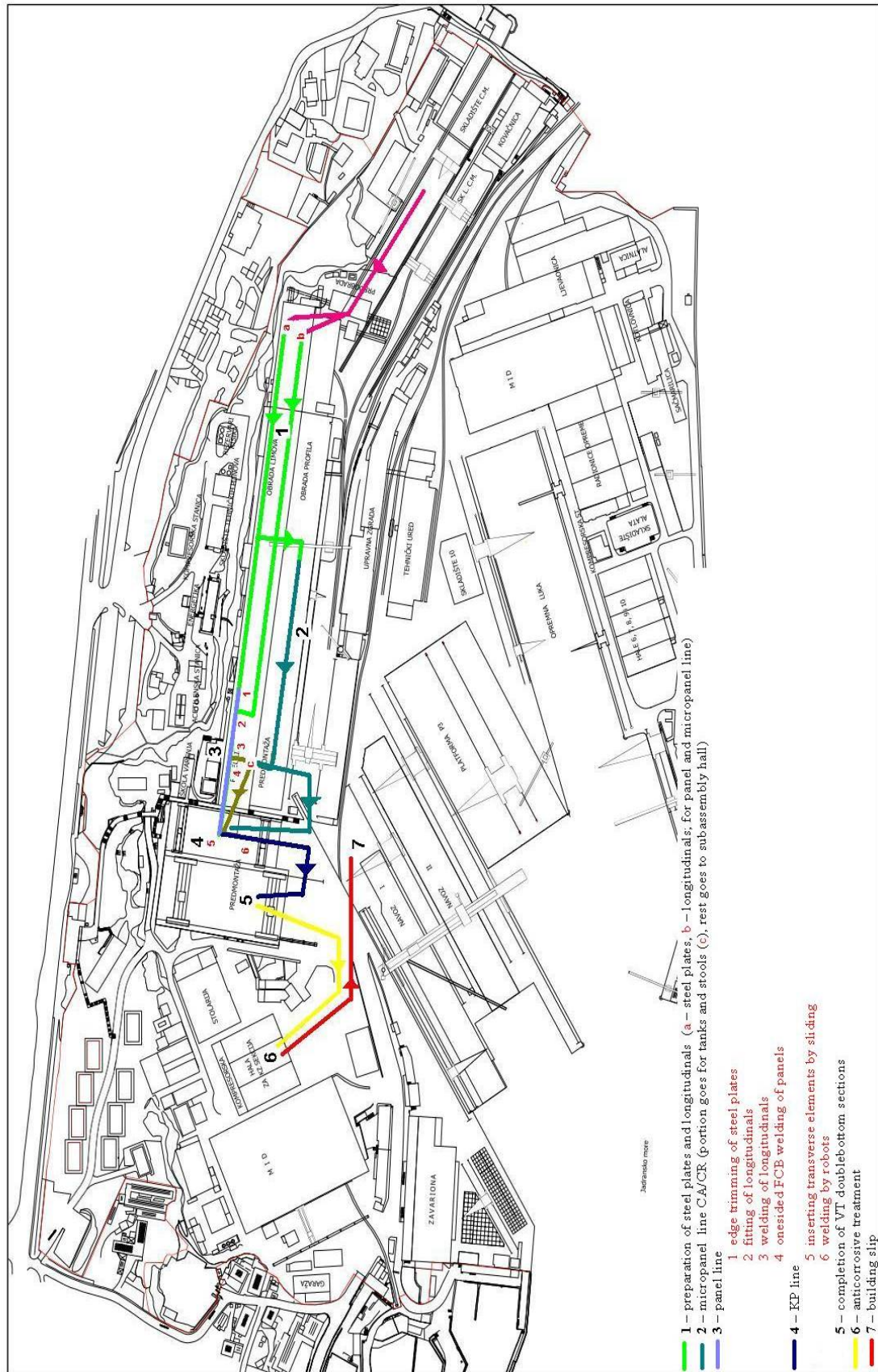


Fig. 5.21. Lean transformation of interim product flow [2], [3], [30]





## 6. RISK ANALYSIS OF BLOCK ASSEMBLY METHODS

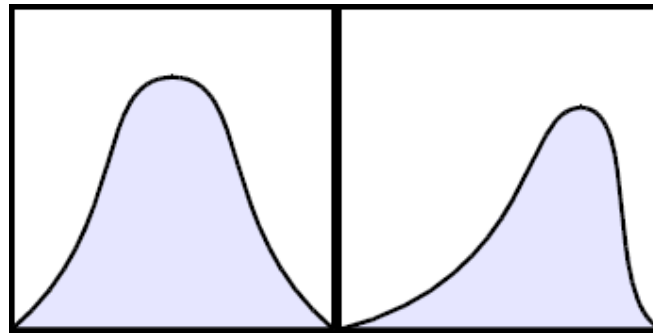
### 6.1. MONTE CARLO APPLICATION IN RISK ANALYSIS

#### @RISK add-in for EXCEL To Determine Man Hours

Monte Carlo analysis is useful in simulating the man hours of large engineering projects which includes shipbuilding projects [14], [18], [19]. The Monte Carlo method includes generating random values for man-hours for methods of double skin block assembly. This includes the different categories of block assembly. Likewise the entire scope of man-hours titled fixed/changing technology can also be simulated [14]. This is valuable for shipyard management in understanding how a panel-block building methodology creates one set of results when technology is fixed, and another set of results if technology is compliantly updated in parallel to the methodology.

In order to generate random numbers, it is first necessary to create a distribution which uses the most likely value, but is "designed to generate a distribution that more closely resembles a realistic probability distribution" [42]. Depending on the values used, the PERT distribution can simulate the normal distribution with a close fit, while also allowing for practical entrance of lower bound and upper bound values.

The advantages of the PERT distribution over the normal distribution are that it creates a curve which is smooth and places "more emphasis on values around (near) the most likely value, in favor of values around the edges" [42]. This practically means that we still have more "trust" in the most likely value estimate over the extreme lower and upper bound values. "Values near the peak are more likely than values near the edges" [43] (See Figure 6.1).



**Fig. 6.1. Examples of the PERT distribution [42]**

Using Excel, it is possible to determine the implied mean by the following method: Create an implied mean column by typing the following command and copying down through the entire column. The implied mean with these values is virtually the same as the values in the most likely column. The command in Excel to be used for in applying Monte Carlo analysis to calculate the implied mean is [44], [45]:

$$=\text{RISKPert}(\text{Lower bound value}, \text{Most likely value}, \text{Upper bound value}) \quad (6.1)$$

The @RISK add-in for Excel is used to run a Monte Carlo simulation by clicking on the simulate icon [46]. Upon this values and curves are generated which display realistic man-hour values. Therefore the Shipyard Management can conclude that using the PERT-Monte

Carlo simulation estimate, the risk is brought to a minimum in proceeding and eventually choosing the appropriate method and the compliant technology [14].

### **The Mathematical Model**

“The PERT distribution is a special case of the beta distribution that takes three parameters: a minimum, maximum, and most likely value (mode). Unlike the triangular distribution, the PERT distribution uses these parameters to create a smooth curve that fits well to the normal or lognormal distributions” [42].

“The beta distribution is characterized by the density function:

$$f(x) = \frac{x^{v-1}(1-x)^{w-1}}{B(v, w)} \quad \dots \quad 0 \leq x \leq 1 \quad (6.2)$$

$$\text{where } B(v, w) \text{ is the beta function } B(v, w) \equiv \int_0^1 t^{v-1}(1-t)^{w-1} dt \quad (6.3)$$

and the distribution function

$$F(x) = B_x(v, w) / B(v, w) \quad \dots \quad 0 \leq x \leq 1 \quad (6.4)$$

$$\text{where } B_x(v, w) \text{ is the incomplete beta function } B_x(v, w) \equiv \int_0^x t^{v-1}(1-t)^{w-1} dt \quad (6.5)$$

Typically, sampling from the beta distribution requires minimum and maximum values (scale) and two shape parameters,  $v$  and  $w$ .

The PERT distribution uses the *mode* or *most likely* parameter to generate the shape parameters  $v$  and  $w$ . An additional scale parameter  $\lambda$  scales the height of the distribution; the default value for this parameter is 4.

In the PERT distribution, the mean  $\mu$  is calculated

$$\mu = \frac{(x_{min} + x_{max} + \lambda x_{mode})}{(\lambda + 2)} \quad (6.6)$$

and used to calculate the  $v$  and  $w$  shape parameters

$$v = \frac{(\mu - x_{min})(2x_{mode} - x_{min} - x_{max})}{(x_{mode} - \mu)(x_{max} - x_{min})} \quad (6.7)$$

$$w = \frac{v(x_{max} - \mu)}{(\mu - x_{min})} \quad (6.8)$$

which are used, with the minimum and maximum scale parameters, to sample the beta distribution” [42].

### **Monte Carlo Simulation**

The Monte Carlo simulation process defines a probability distribution for each activity man-hour values. In the case using EXCEL @RISK add-in, the Beta distribution as mathematically explained above is used. It is non-symmetrical and represents real world man-hour durations. The EXCEL @RISK simulation tool picks a random man-hour duration from each distribution and uses that for the actual man-hours for the activity. Then it calculates (using the native tool) the man-hours of observed activities. It does this 1000 times, until a histogram of man-hours is accumulated [45], [46].

## **6.2. MONTE CARLO RISK ANALYSIS OF ASSEMBLY METHODS**

Using Table 4.9 with man-hour values for the four different categories for block assembly using DFP methods, and then table 5.6 from the previous section for the value of assembly time of iterim products using *lean manufacturing* methods, the table necessary for risk analysis is created below.

**Tab. 6.1. Monte Carlo input table in Excel**

Block Assembly Method Category	Lower bound	Most likely	Upper bound
	Man-hours	Man-hours	Man-hours
FLT Category 1	2783	2930	3077
FLT Category 2	2924	3077	3230
FLT Category 3	3450	3633	3815
FLT Category 4	3620	3809	3998
F/CLT	2051	2930	3809
Lean Transformation	1123	1182	1241

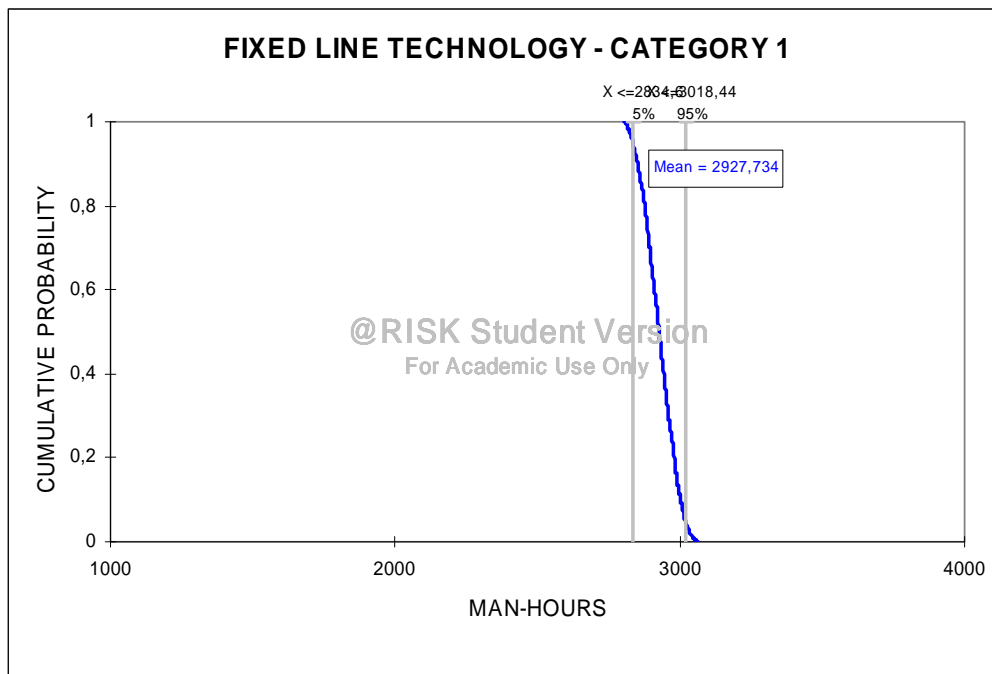
### **Legend of Table 6:**

FLT Category 1: Fixed Line Technology of Category 1 (Block Assembly Method 1c, DFP),  
 FLT Category 2: Fixed Line Technology of Category 2 (Block Assembly Method 2c, DFP)  
 FLT Category 3: Fixed Line Technology of Category 3 (Block Assembly Method 2e, DFP),  
 FLT Category 4: Fixed Line Technology of Category 4 (Block Assembly Method 5e, DFP)  
 F/CLT: Fixed/Changing Line Technology.  
 Lean Transformation

The activity column lists the following as described:  
 All the values derive from Table 4.9 described earlier.

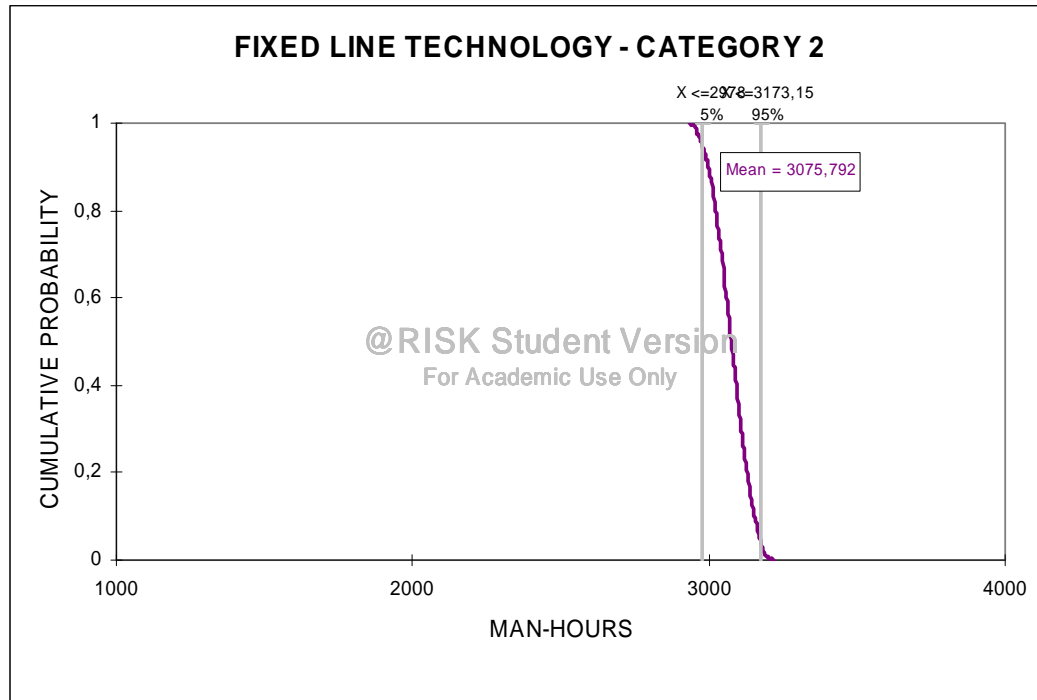
- FLT Category 1 is the Fixed Line Technology of block assembly method 1c. The most likely value of 2930 man-hours derives from Category 1, line technology of table 4.9. The lower and upper bound values of 2783 and 3077 respectively are approximately  $\pm 5\%$  of the Category 1 value of 1306 man-hous for line technology.
- FLT Category 2 is the Fixed Line Technology of block assembly method 2c. The most likely value of 3077 man-hours derives from Category 2, line technology of table 4.9. The lower and upper bound values of 2924 and 3230 are approximately  $\pm 5\%$  of the Category 2 value of 3077 man-hours.

- FLT Category 3 is the Fixed Line Technology of block assembly method 2e. The most likely value of 3633 man-hours derives from Category 3, line technology of table 4.9. The lower and upper bound values are approximately  $\pm 5\%$  of the Category 3 value of 3633 man-hours for line technology.
- FLT Category 4 is the Fixed Line Technology of block assembly method 5-2e. The most likely value of 3809 man-hours derives from Category 4, line technology of table 4.22. The lower and upper bound values are approximately  $\pm 5\%$  of the Category 4 value of 3809 man-hours for line technology.
- F/CLT is the Fixed/Changing Line Technology simulation which represents all four categories. The upper bound value of 3809 man-hours represents the highest duration time recorded by Category 4, line technology of table 4.9, while the lower bound value is represented by a 30% decrease from the Category 1 value 2930 man-hours to 2051 man-hours. 30% is the improvement expected when technology and methodology in the panel-block assembly are improved in parallel [2].



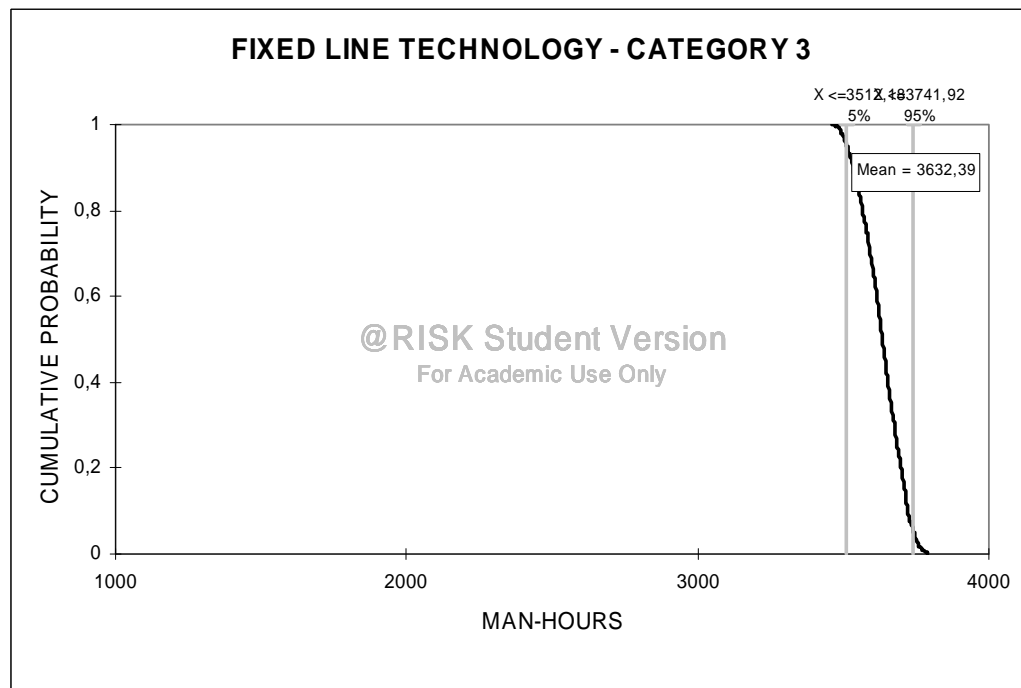
**Fig. 6.2. Fixed line technology – category 1**

Fixed line technology means making use of the automated panel line using the first method mentioned earlier and not changing the technology. The expected man hours is **2927,7** hours.



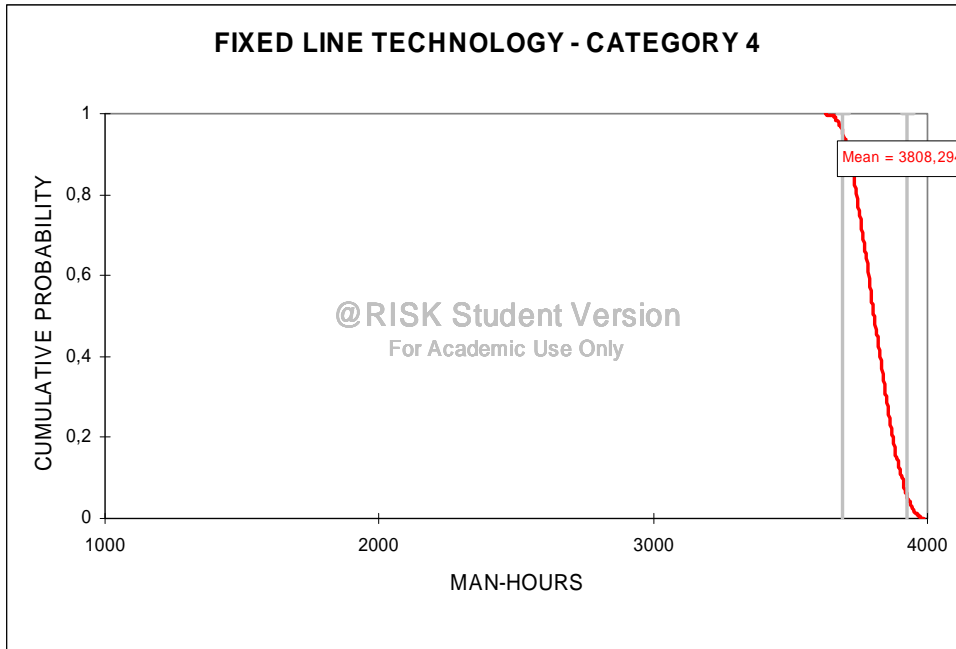
**Fig. 6.3. Fixed line technology – category 2**

Fixed line technology making use of the automated panel-block line using the second method. The expected man hours is **3075,8** hours. Even though method 2 is superior to method 1, the duration time for producing the double bottom block has increased.



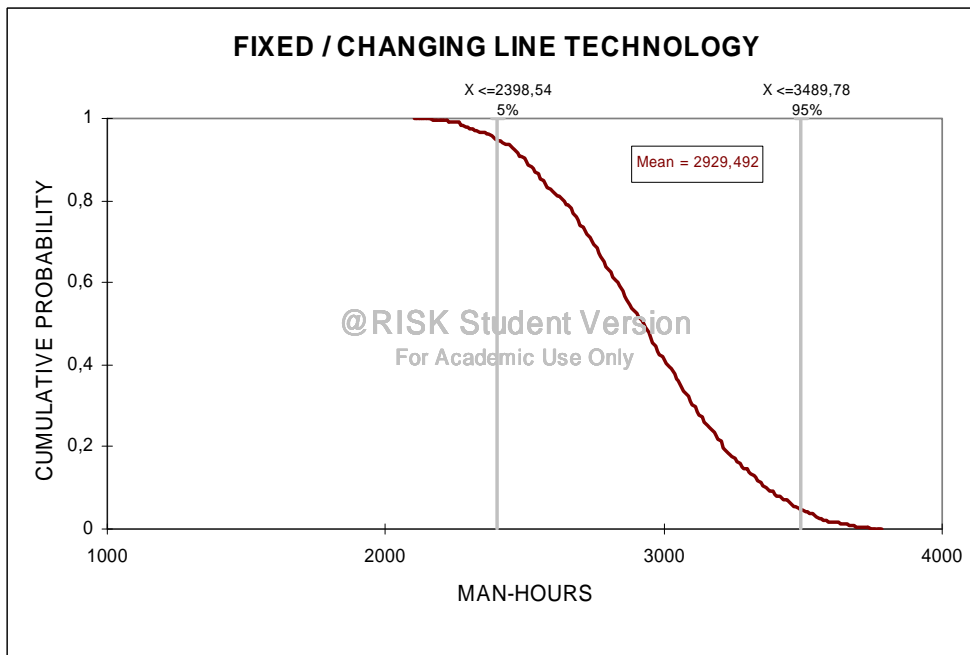
**Fig. 6.4. Fixed Line Technology – category 3**

Fixed line technology using method 3 yields an even greater value of man hours: **3632,4** hours. The results show that by keeping the same technology level (fixed) of the automated panel-block line, and only altering superior methods, the man hours increase instead of decreasing.



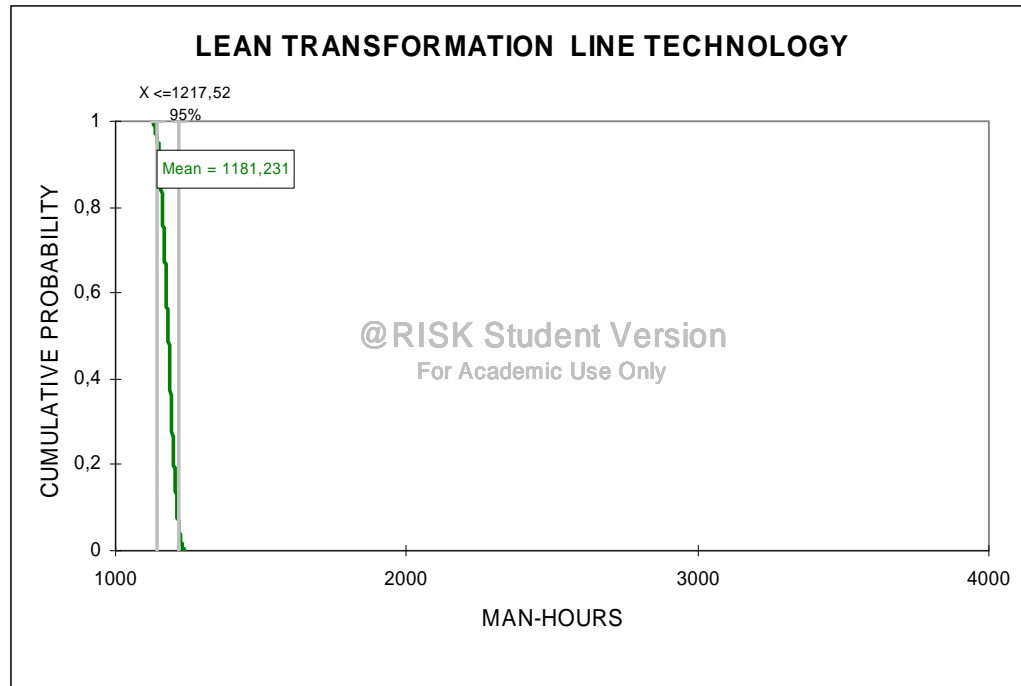
**Fig. 6.5. Fixed line technology – category 4**

Fixed line technology using method 4 yields an even greater value of man hours: **3808,3** hours. The results show that by keeping the same technology level (fixed) of the automated panel-block line, and only altering superior methods, the man hours increase instead of decreasing.



**Fig. 6.6. Fixed / changing line technology**

The Fixed/Changing Line Technology curve illustrates all four categories. The part of the curve which is left of the mean of **2929,5** hours decreases towards **2398,5** hours. It is important to understand that man hours will decrease only when the technology of the panel-block line is adjusted to be in compliance with the improved methodology. This is the expected value if the technology of the automated panel-block is adjusted to be up to par with the superior assembly methods. On the other hand moving to the right of the mean is the situation when technology is not adjusted but remains fixed while applying improved methods. In this simulation it is shown as **3489.8** hours which is an increase in man-hours.



**Fig. 6.7. Lean transformation line technology**

Finally, the Lean Transformation Line Technology curve illustrates the mean value of 1181,2 man-hours which is close to the calculated value of 1182 man-hours. When 3.Maj shipyard has its panel-block assembly transformed using both lean technology and methodology for block assembly, the greatest improvement of 60% decrease from original 2930 man-hours of the present state technology and methodology.

### 6.3. DISCUSSION OF RESULTS

The Fixed line technology curve for Category 1 shown in Figure 6.2 above, which models the present day methods using the facilities of the panel-block assembly work stations of interim products for a double bottom block for 3.Maj shipyard, shows a mean value of 2927,7 man-hours which is very close to the value calculated from the case study in section 4 of 2930 man-hours. Figure 6.3 models the behaviour of Category 2 methodology for assembling the double bottom sections with the present technology of 3.Maj shipyard. The mean value of 3075,8 man-hours is an increase of 5 percent from the 2927,7 man-hours of category 1. This increase occurred because even though Category 2 includes the use of fitted-slots instead of cut-outs, the present-state technology of the shipyard is not able to assemble transverses with fitted slots as efficiently as transverses with cut-outs.



Concerning Figure 6.4 which shows the Fixed Line Technology curve of Category 3, where cut-outs are completely replaced with fitted slots, the mean value increases even further to 3632.4 man-hours, which is 24 percent increase over the 2927.7 man-hours of Category 1, Figure 6.2. This increase is because the complete replacement of cut-outs on transverses with slots results in additional difficulties during the assembly phase of built-up panels, where the present state technology level requires more man-hours to perform the assembly steps. The accuracy control of the workstation are designed for assembling transverses with cut-outs instead of slots. Moving on to Figure 6.5, which shows the Fixed Line Technology curve of Category 4, where not only are the cut-outs on the transverses completely replaced with fitted slots, but the transverses are built on matrices off the workstation. The mean value of 3808,3 man-hours means an even greater increase over 2927,7 man-hours of 30 percent. The additional need for assembly of the internal structure on a matrix off the workstation requires more adjustments by the workers still working with the same fixed technology in the shipyard which results even higher man-hours.

Figure 6.6 of the Fixed/Changing line technology curve shows the behaviour of both fixed technology and changing or adapting the technology to complement the new assembly methodology. The mean value of 2929,5 man-hours is close to 2927,7 man-hours of Category 1 which is the base for all comparisons. Moving to the right of the mean value of 2929.5 man-hours, with the technology level of the block assembly process fixed, approaches the man-hour values for Categories 2, 3, and 4. However, moving to the left of the mean value while applying the complementary technology changes to the facilities results in decreases of man-hours as expected due to the fact that lugs have been eliminated and there is less welding as a result. Therefore, the maximum improvements are possible with applying Category 4, where the internal structure with slots in the transverses are built on a matrix separately and then assembled on a panel. The savings are 30 percent from the 2927,7 man-hours or 2051 man-hours.

Figure 6.7 shows the Lean Transformation Line Technology where the mean value of 1181,2 man-hours is very close to the calculated value of 1182 man-hours, which is a 60 percent improvement over 2927.7 man-hours. The lean transformation technology and methodology is the closest to category 4, where slot technology is used instead of cut-out technology. Likewise, the internal structure is built on a matrix off the workstation. However, the additional benefits arrive from applying not only the DFP advantages of separate assembly on a matrix and the use of slots instead of cut-outs, but also as a result of the one-piece flow, decrease of internal transportation, and application of welding technologies such as FCB, with better organised process engineering application through the use of PWBS adapted for lean manufacturing, and the use of detailed Gantt charts.

## **7. FUTURE DESIGN GUIDELINES FOR FLAT DOUBLE SKIN BLOCK ASSEMBLY**

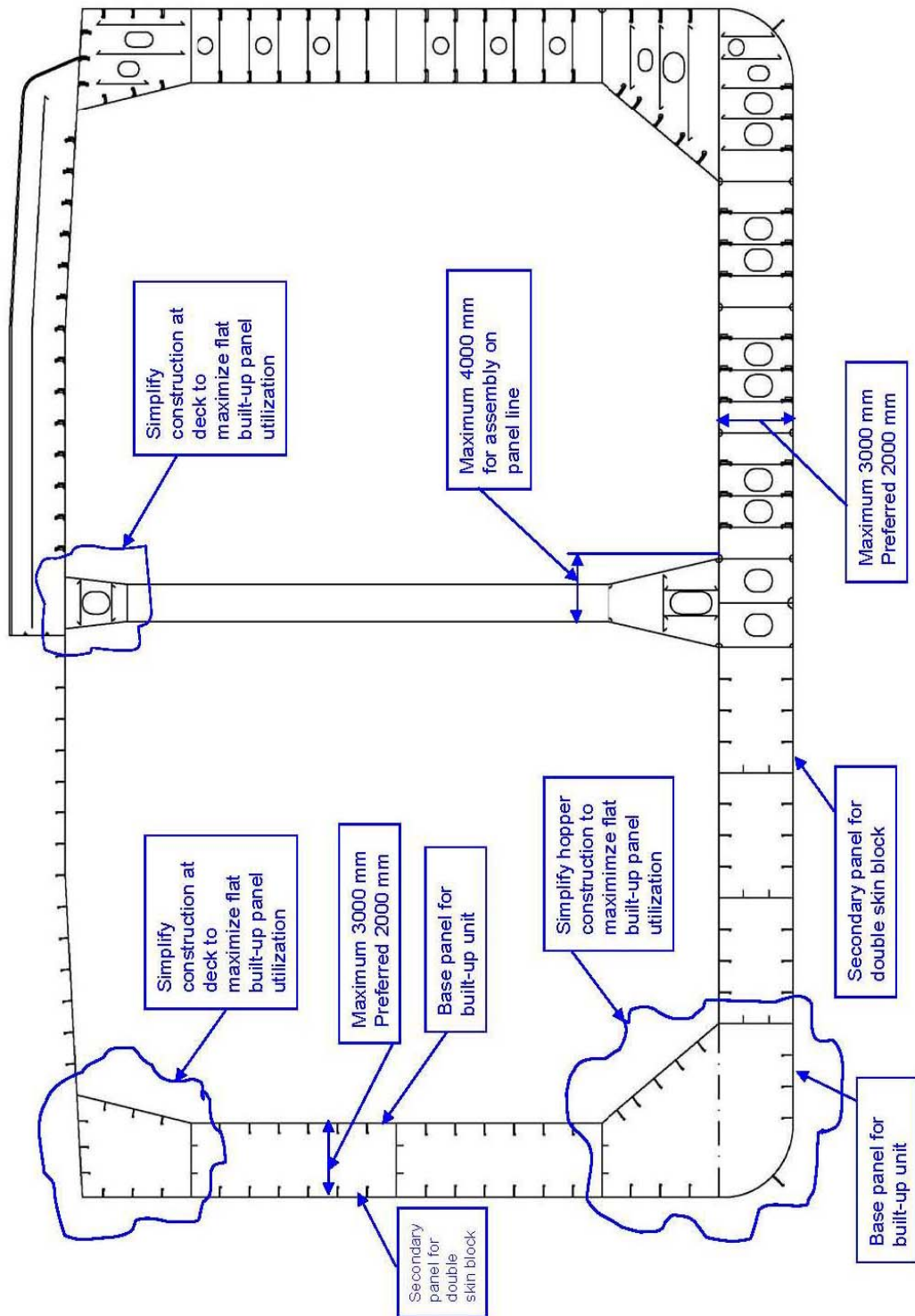
The aim of creating future guidelines for the assembly of interim products is to assist naval architects in designing future vessels particularly Chemical tankers. The use of the midship section provides guidelines for assembling panels on the panel line, along with defined maximum and minimum spacing between longitudinals, locations of the spacings and the edge preparation and orientation of the plates on the panel line, and the possible scope of steel plate thicknesses as well. The midship section shows the upper and lower wing tanks with a simplified construction by the deck and the double bottom (See Figure 7.1). The construction drawings of the ship hull, a review of the basic vessel structural parts is provided from the midship section. This drawing provides a cross section of the ship located in the middle of the ships length in the cargo hold or parallel middle body of the ship, where the basic dimensions of the ships structure is seen on the drawing.

From the point of view of strength, a vessel is a very complex transport vehicle. Forces from various directions and magnitudes act on the vessels structure. The various loads and forces are difficult to pinpoint because they are constantly changing and depend on many factors such as cargo loading, wind, waves and other factors. The greatest forces are typically foreseen when the vessel is launched from a slipway, during dry-docking operations or during a collision with another vessel or navigating through extreme waves [47]. The elements of the ship structure must counteract against forces in order to not change the hull form through distortions and eventually cracking and fracturing. Considering the complex loadings on the ship structure, longitudinal, transverse and local strength requirements of the hull must meet minimal Classification Society requirements. One of the most complex structural engineering problems is determining the sufficiency of a ships hull. In order to determine the construction methods of a ship, it is necessary to take into consideration the vessels purpose as well as its main dimensions.

It is necessary to define the maximum lengths of the longitudinals, spacing of the longitudinals, location of lugs, edge preparation and orientation of the edges of steel plates on the panel line, and define the thicknesses of the steel plates.

Considering that the best structural design is often not technologically the simplest or economical, it is necessary to be aware of the situation, and in the early design phases to take into account the facility constraints of the shipyard in order to build the vessel in the most technological way and most economical as well. Therefore it is necessary to understand the hull structure, as well as the building methods, in order to achieve the optimal solution which is a compromise.

Figure 7.1 below illustrates a generic midship section of a typical chemical tanker built at the yard with elements labeled in order to guide naval architects in future designs and projects. This is a typical midship section where some basic dimensions are labelled, as well as simplified construction of upper and lower wing tanks, as well as primary and secondary panels. The midship section is typical because it has a double bottom, double sides, wing tanks and structural elements on the deck are located on the outer side of the hull. In this specific example, it is possible to see that the vessel also has a stool and a longitudinal corrugated bulkhead which separates two cargo holds.



**Fig. 7.1. Generic midship section of a chemical tanker with constraints for present production program [2], [30], [47]**

## Subassembly

The subassembly phase is where panel assembly starts along the panel line. The scope of work depends on the technological-technical capabilities of each individual shipyard. The table below shows the main characteristics of the 3.Maj shipyard panel line. Based upon these characteristics, it is possible to design panels that will be compliant to the automated panel line. This includes the steel plate dimensions, thicknesses, and weight, as well as the longitudinal dimensions (See Table 7.1).

**Tab. 7.1. Main characteristics of the panel line of 3. Maj shipyard [30]**

Production phase	Panel line	Main characteristics
SUB-ASSEMBLY and ASSEMBLY	Workstations	<ul style="list-style-type: none"> <li>- Workstation I: joining and welding of the first side</li> <li>- Workstation II : rotate and turn over, welding on the second side</li> <li>- Workstation III: marking, lofting , autogenic cutting, ultrasound inspection</li> <li>- Workstation: positioning, fairing and welding profiles</li> <li>- Workstation V: laying away the panels and preparing for transport</li> </ul>
	Panel measurements	<ul style="list-style-type: none"> <li>- Length 2880 – 14500 mm</li> <li>- Capability for turning over for panels of 4000 – 15000 mm</li> <li>- Width 4000 – 15200 mm</li> <li>- thickness 8 - 35 mm</li> <li>- mass without profiles 25000 kg</li> <li>- mass with profiles 35000 kg</li> <li>- max. surface pressure 5 kPa</li> <li>- material: shipbuilding steel</li> </ul>
	Steel plate dimensions	<ul style="list-style-type: none"> <li>- length 3300 – 15000 mm</li> <li>- width 1000 – 3000 mm</li> <li>- thickness 8 – 35 mm</li> <li>- mass 20000 kg</li> </ul>
	Longitudinal dimensions	<ul style="list-style-type: none"> <li>- type of longitudinal : angle, variety T, bars, bulb</li> <li>- max. width of flange variety T longitudinal 200 mm</li> <li>- max. width of flange for T longitudinal is 400 mm</li> <li>- thickness of the web 6 – 40 mm</li> <li>- thickness of the flange 10 – 40 mm</li> <li>- height of T longitudinal 150 - 800 mm</li> <li>- length of longitudinal 3000 – 15200 mm</li> <li>- mass 2500 kg</li> <li>- min. height bulb longitudinal 160 mm</li> <li>- min. height of flat bar longitudinal 120 mm</li> <li>- hang of longitudinal from both sides of the panel 200 mm</li> </ul>

Smaller panels and transverses of the CA type designation are assembled on the micropanel line. The characteristics of the micropanel line and the built-up panel line are included below (See Table 7.2).

**Tab. 7.2. Characteristics of the micropanel line and built-up panel lines [30]**

Production phase		Main characteristics
SUB-ASSEMBLY and ASSEMBLY	<b>Sub-assembly and assembly lines</b>	
	Automated line for small fabricated elements and or/ subassemblies (CA)	<ul style="list-style-type: none"> <li>- steel plate dimensions:               <ul style="list-style-type: none"> <li>o length 1200 – 12500 mm</li> <li>o width 800 – 4000 mm</li> <li>o thickness 6 - 30 mm</li> </ul> </li> <li>- longitudinal dimensions:               <ul style="list-style-type: none"> <li>o bulb longitudinal min. 140 x 7 mm; max. 550 x 35 mm</li> <li>o T longitudinal min. 150 x 50 x 12/28 mm; max. 550 x 250 x 14/35 mm</li> <li>o Length of longitudinal 300 – 12500 mm</li> <li>o Spacing between longitudinals 500 mm</li> <li>o mass of longitudinal max. 800 kg</li> </ul> </li> </ul>
	Robotic line for micro-assemblies (CR)	<ul style="list-style-type: none"> <li>- platform dimensions 60000 x 4000 mm</li> <li>- max. steel plate dimensions 12000 x 4000 mm</li> </ul>
	Built-up panel (KP) line for two-dimensional sections	<ul style="list-style-type: none"> <li>- panel dimensions:               <ul style="list-style-type: none"> <li>o length 4000 – 14500 mm</li> <li>o width 4000 – 14500 mm</li> <li>o mass 100 t</li> </ul> </li> <li>- girder dimensions :               <ul style="list-style-type: none"> <li>o max. length 12500 mm</li> <li>o max. height 3500 mm</li> <li>o max. mass 5 t</li> </ul> </li> </ul>

## Panel stiffeners

The following figure 7.2 shows the double bottom of the chemical tanker. The basic elements are the longitudinals (bottom and tank top) stiffeners and longitudinal girders. The location and type of lugs is determined according to the position and method of assembling structural elements. During placement of the lugs it is necessary to know which elements are continuous and which are intercostal. In this example the longitudinal stiffeners of the bottom are continuous longitudinal elements which pass through the transverse floors and must have the appropriate type of lugs fitted. The type used in this case is Type 102 which is taken from the shipbuilding standards. Figure 7.3 below shows a typical penetration through other elements of the structure. This is a standard penetration typically used with HP (bulb plate) stiffeners. Depending on the change in dimensions of the longitudinal stiffeners, particularly H which is the height of the longitudinal, the corresponding lug plate with a height h and width  $e+a$  is made (See Figure 7.4).

Figure 7.5 illustrates the optimal block assembly method for the present day shipyard facilities, while Figure 7.6 illustrates the lean transformed block assembly for the proposed future state of the shipyard. Both figures show four assembly steps of a double bottom section.

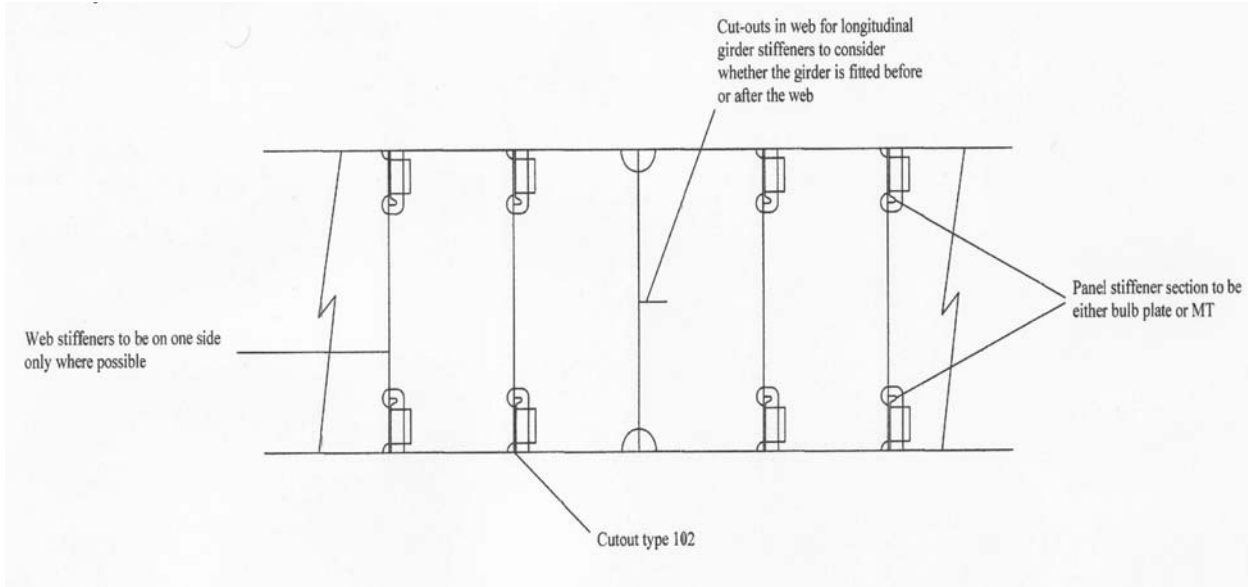


Fig. 7.2. Guidelines for flat double skin block assembly [17]

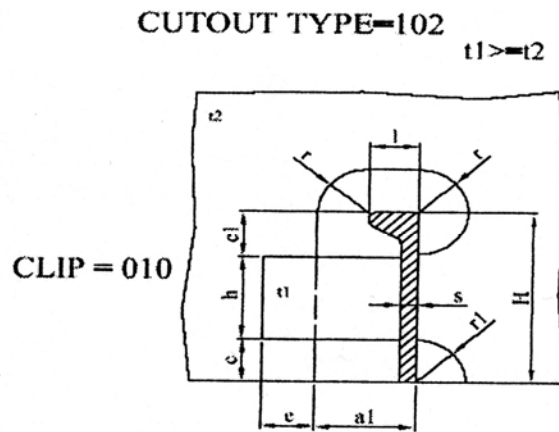


Fig. 7.3. Typical cutout type penetration [30]

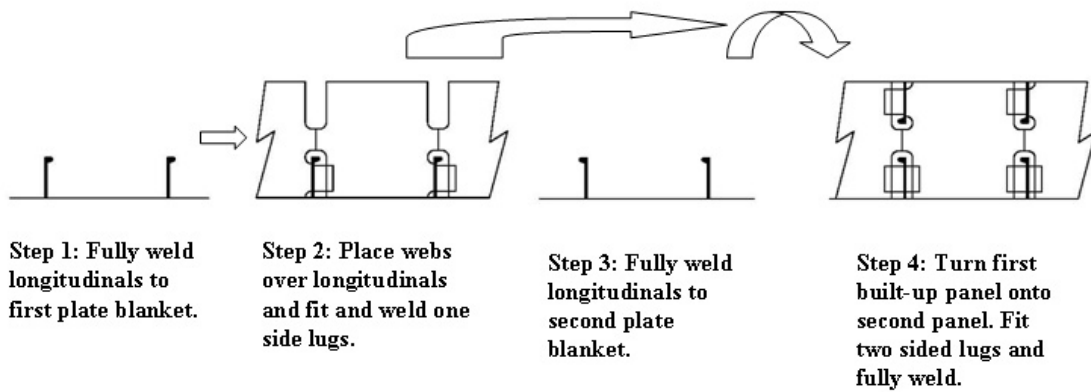
CUT OUT PARAMETERS REFERRED TO P1-P6  
PARAMETRI PROLAZA - VRIJEDI ZA P1 - P6

H	c1	h	h1	c	r1	r
140	30	80	110	30	35	30
160	40	90	120			
180-200	50	90-110	130-150	40	40	
220-240	60	120-140	160-180			
260-280	70	140-160	190-210	50	50	
300-320	80	170-190	220-240			
340-370	90	200-230	250-280			
400-430	100	250-280	300-330			

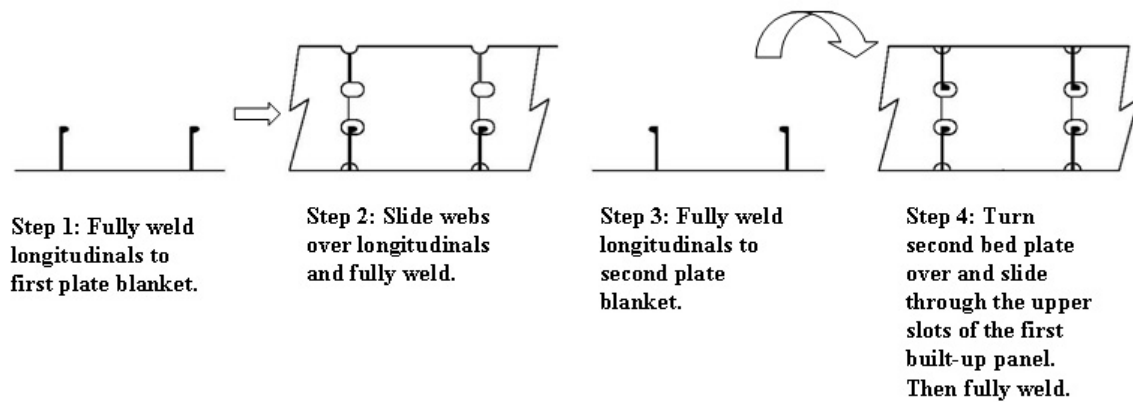
THICKNESS DEBLJINA $t1=t2$	OVERLAP PREKLOP c
$t1 \leq 8$	40
$8 < t1 < 14$	50
$t1 \geq 14$	60

$a = l + 2r$   
 $a1 = l + r$   
 $a2 = l + 160$

Fig. 7.4. Typical cutout type penetration type = 102 [30]



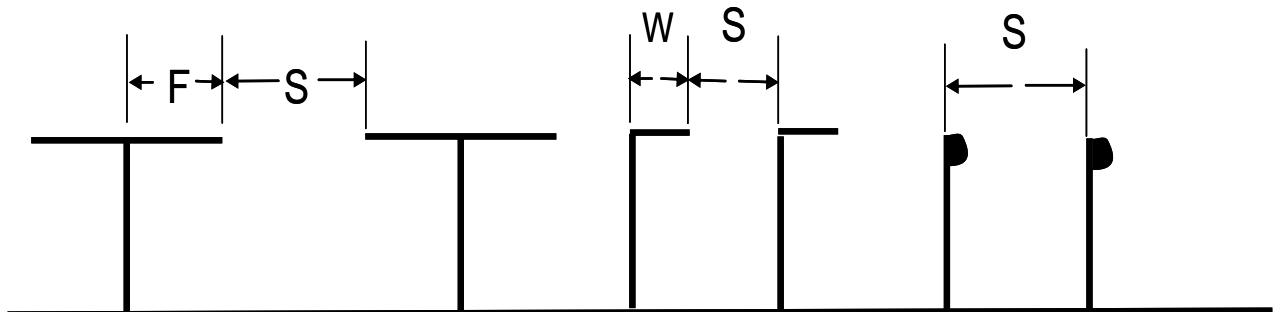
**Fig. 7.5. Block assembly method for present state shipyard facilities**



**Fig. 7.6. Block assembly method for future lean transformed state shipyard facilities**

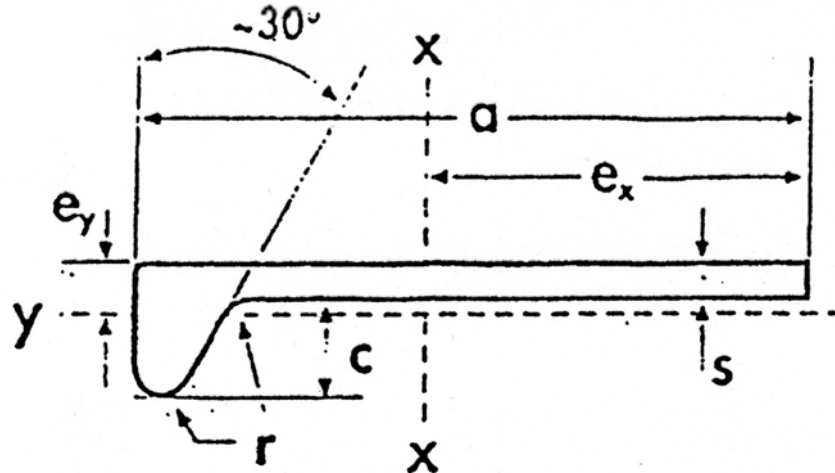
**Sizes and spacing of longitudinals**

Longitudinal stiffeners can be in various shapes and sizes. The maximum sizes and minimal spacing of the longitudinals is standardized and are used as such during design. Depending on the type of longitudinal used (MT: manufactured T, or bulb plate) the measurements are read from tables provided by the manufacturer of the longitudinals. The symbols in Figure 7.7 are as follows: F: width of flange, S: spacing, W: width of flange from L-stiffener.



**Fig. 7.7. Illustration of longitudinal spacing symbols [2]**

The height of the bulb plate longitudinals vary between 220-340 mm, and the width is between 10-14 mm. Bulb plate (HP) longitudinals are recognized from the standard designation (e.g. HP 320 x 14) from which the main profile dimensions are received.



**Fig. 7.8. Typical cutout type penetration type = 102 [48]**

a: height (mm); s: thickness (mm); c: width (mm); r: radius (mm);  $e_x$ : distance to the neutral x-axis;  $e_y$ : distance to the neutral y axis.

Figure 7.8 above illustrates the main dimensions for a bulb plate longitudinal. Standard lengths of longitudinals from the manufacturer are between 6-18 m, and the sizes of bulb profiles fall in the range of HP a X s: 60 x 4 – 430 x 17

The construction program for chemical tankers and other commercial vessels extensively make use of the HP longitudinals. The bulb plate longitudinal dimensions are determined by making a calculation of the minimal section modulus for the stiffeners in combination with standard profiles that are produced by the manufacturer. For the situation of the chemical tanker in the case study, the following table lists the bulb plate longitudinals with their main dimensions a for height and s for thickness.

**Tab. 7.3. Longitudinal dimensions of bulb profiles for the chemical tanker**

a (mm)	s (mm)
340	14
320	12
300	12
280	12
280	11.5
260	10
220	10

**Legend:**

a – height of the bulb profile  
s – width of the bulb profile



The spacing of the secondary and primary elements are received from the Classification Society calculation. For the chemical tanker in the case study, the spacing of the secondary elements was 800 mm. This means that the spacing of the longitudinals which are secondary elements of the structure are a maximum of 800 mm. It is important to precisely determine the maximum spacing of elements because in contrary it is possible to have large deformations and damage to the hull structure. Depending on the position of the ship, various longitudinals with dimensions from HP 220 x 10 to HP 340 x 14 were determined from a combination of structural combinations and use of HP tables [48].

### **Conclusion of the guidelines**

The aim of this section was the creation of guidelines which will be useful in the pre-contract phase and during the production phase. The general guidelines for a typical chemical tanker are made. The technological process of vessel assembly is continuous without moving upstream again. This is the main prerequisite for economical and efficient construction. Efficient production requires well preparation and quality guidelines for assembly. The vessel shown in this section and types like it are built with longitudinal framing which is common in tanker construction. It is characterized by longitudinals on the bottom and the deck, with strong web frames and longitudinal frames on the vessel sides.

## 8. CONCLUSIONS

Improving the flow of interim products in a shipyard production environment is not automatically an easy task, regardless of the superficial application of improving technologies or building methodologies. In order to remain competitive in the demanding shipbuilding market, it is logical to move towards applying the *lean manufacturing* concept. A *lean manufacturing* methodology which will aid many shipyards that presently use traditional methods for assembling blocks is very useful. In addition shipyard management needs to be reassured that any changes to the technology of the facilities and the assembly methodology will produce significant improvements before they provide the green light for the application of the strategic decision towards a *lean manufacturing* transformation.

The use of a PWBS is definitely a prerequisite for the successful implementation of a *lean manufacturing* transformation. Likewise, the *design for production concept* also complements the PWBS. *Lean manufacturing* takes major strides due to the implementation of one-piece flow in the panel-block assembly lines. Likewise, JIT and built-in quality are inherent in the lean assembly methodology. While the *design for production* concept is to some extent applied in the subject shipyard of the case study, there is a lack of a PWBS organization. This is felt in the shipyard, since production decisions are not based on a strategy of repeatable interim products. This can be seen with the assembly of the three dimensional sections, T-sections (wing tanks and stools), which are performed on static workstations relatively far from the final assembly hall where very large three dimensional sections (VT) otherwise known as the VT blocks are finally assembled. The interim products that make up the T-sections could be assembled with the automated facilities but are not. Therefore, the *lean manufacturing* transformation includes the elimination of the peripheral static workstations as unnecessary and redundant, and maximizes the use of automated facilities which includes the panel line, the built-up panel line, and the micro-panel line. In addition, the use of unit panels and slits in transverses instead of cut-outs with lugs additionally significantly eliminates unnecessary motions and reduces the amount of welding work, while improving flow. Thereby, the proposed *lean manufacturing* transformation of the 3.Maj shipyard increases the throughput of assembled blocks (double-bottom and wing tanks from the parallel middle body) while simultaneously decreasing the man-hours and duration time in assembly. The analysis of the present state of 3.Maj shipyard confirms that it is endowed with space and capabilities to undergo the *lean manufacturing* transformation for a future improved state.

The analysis of the interim products of different types of vessels (chemical tanker, car carrier, crane barges) and the facility production constraints shows that they can be assembled with virtually the same cycle times when using design guidelines prior to vessel contracting and production design. Since most shipyards have a production program which produces more than one type of vessel, it is necessary to consider the design variations and structural configurations of the interim products. The management of each shipyard must fine tune their design and production facilities towards a realistic and acceptable production program. Once that is done, the design variations and structural configurations of the vessels in the production program need to be analyzed which was done in this dissertation for a chemical tanker, a car carrier and a crane barge. Likewise, it is necessary to analyze the panel-block assembly lines as one of the crucial main production flows. Understanding the assembly constraints in conjunction with the production program enables a set of guidelines to be made,

which naval architects will use in future designs and negotiations. These guidelines essentially aid naval architects by forcing them to consider production constraints and recommendations.

In parallel it is necessary to analyze not only the technological constraints but the assembly methodology used on the panel-block line assembly process. The amount of welding of a typical double-bottom block decreased, and the man-hours actually increased, because the technology of the panel-block assembly line was not adjusted. Monte Carlo risk analysis confirmed the results and yielded more realistic man-hour bounds which is useful information both for shipyard management and production. Likewise it demonstrated how risks can be avoided by making complementary adjustments to both the technology and methodology of block assembly.

Monte Carlo analysis in accordance to lean manufacturing principles aids shipyard management to make production decisions with lower risk. For instance without this analysis most managers and even many designers and engineers would logically conclude that Category 2, 3 and 4 which reduces the weld length required to assemble a block should be immediately applied by the shipyard production. However, the results show that Category 1 is the best method for the shipyard with the present technology level. In order to move towards the superior Category 4 which completely eliminates lugs, it is necessary to make a *lean manufacturing* transformation using unit panels and slits instead of cut-outs as described in this work. Even though IHI shipyards in Japan are virtually one of the only shipyards that have come the closest to *lean manufacturing* in shipbuilding, it is possible by using the methodology described in this work to estimate the man-hours of interim products of any given shipyard with a *lean transformation*. The methodology would involve a DFP case study as a foundation for the transformation. This includes the development of Gantt charts. The lean transformation involves changing the workstations of the traditional panel-block assembly lines to one-piece flow with unit panels, slits on the internal structure and egg-box construction. The resulting man-hour savings of 60% or more could be the justification for applying a *lean transformation* in the very near future.

Suggestions for future research include continuing the DFP analysis of interim product outfitting and then making a lean transformation, along with risk analysis. This would require a creation of design tables and Gantt charts for the present method of outfitting of the double bottom blocks, which includes pipes, ladders, man-hole covers and trays, as well as anti-corrosion protection and painting. Then, a lean transformation adapted for outfitting would be made. Using Monte Carlo risk analysis, it would be possible to ease the decision making process for management in determining the best outfitting method.

## 9. REFERENCES

- [1] Storch, R.L., Lim, Sanggyu., *Improving flow to achieve lean manufacturing in shipbuilding*, Production Planning and Control, Vol. 10, No.2, 1999.
- [2] *Design for Production Manual*, 2<sup>nd</sup> edition, National Shipbuilding Research Program, U.S. Department of the Navy Carderock Division, Vol. 1-3, 1999.
- [3] Liker, J.K., Lamb, T., *What is Lean Ship Construction and Repair?*, Journal of Ship Production, Vol. 18, No.3, 2002.
- [4] Koenig P.C. et al., *Lean Production in the Japanese Shipbuilding Industry?*, Journal of Ship Production, Vol. 18, No.3, 2002.
- [5] Anderson, D.M.: *Build-to-Order and Mass Customization, the Ultimate Supply Chain Management and Lean Manufacturing Strategy for Low-Cost On-Demand Production without Forecasts or Inventory*, CIM Press, 2004, ISBN 1-878072-30-7.
- [6] Lamb, T.: *Worldwide Shipbuilding Productivity Status and Trends*, Pan American Conference of Naval Engineering, Maritime Transport and Port Engineering, 2007.
- [7] *National Shipbuilding Research Program: Integrated Hull Construction, Outfitting and Painting (IHOP)*, Naval Surface Warfare Center, Bethesda, MD., 1983.
- [8] *Productivity Improvement in Shipyard Steel Fabrication Through Integrated Material Handling Technology, Proceedings of the IREAPS Technical Symposium*, NSRP, 1982.
- [9] IHI shipyards:([http://www.ihico.jp/en/products/ships\\_offshore/index.html](http://www.ihico.jp/en/products/ships_offshore/index.html)), 2011.
- [10] Okomuto, Y., *Advanced Welding Robot System to Ship Hull Assembly*, Journal of Ship Production, Vol. 13, No.2, 1997, 101-110.
- [11] *ISSC Committee V.3: Fabrication Technology*, 16<sup>th</sup> International Ship and Offshore Structures Congress, Vol 2, 2006.
- [12] [http://www.latest-science-articles.com/Economics\\_Management/The-Study-of-Lean-Shipbuilding-System-6670.html](http://www.latest-science-articles.com/Economics_Management/The-Study-of-Lean-Shipbuilding-System-6670.html) , 2010.
- [13] Thomas, G., Seward, M.: *Ship Production Lectures*, Australian Maritime College, 2009.
- [14] Kolić, D., Fafandjel, N., Čalić, B.: *Determining how to apply the design for production concept in shipyards through risk analysis*, Engineering Review 1 (2010) 30, 63-72.
- [15] Dlugokecki V., Fanguy, D., Hepinstall, L.: *Leading the way for mid-tier shipyards to implement design for production methodologies*, Journal of Ship Production, Vol. 25 (2009), No.2, p.99-108.

- [16] Storch, R.L., *Structural Design for Production: A Human Factors Viewpoint*, Ship Structure Symposium, SNAME and the Ship Structure Committee, 1996.
- [17] Kolić, D., Fafandjel N., Bićanić, D., *Proposal for the determination of technological parameters for design rationalization of a shipbuilding production program*, Engineering Review 2 (2010) 30, 59-69.
- [18] Van Dorp, J.R., Duffey M.R., *Statistical dependence in risk analysis for project networks using Monte Carlo methods*, International Journal of Production Economics - Elsevier, Vol. 58, 1999, p. 17-29.
- [19] Duffey, M.R., Van Dorp, J.R.: *Risk analysis for large engineering projects: Modelling cost uncertainty for ship production activities*, Journal of Engineering Valuation and Cost Analysis, Vol. 2, 1999, 285-301.
- [20] Berends, K., *Engineering and construction projects for oil and gas processing facilities: Contracting, uncertainty and the economics of information*, Energy Policy – Elsevier, Vol. 35, 2007, 4260-4270.
- [21] *ISSC Committee V.3: Materials and Fabrication Technology*, 17<sup>th</sup> International Ship and Offshore Structures Congress, Vol 2, 2009.
- [22] The National Shipbuilding Research Organization and the Lean Initiative, NSRP-ASE 2004.
- [23] *Improving Organizations and People for Lean, Affordable Shipbuilding: A Strategy Outline*, NSRP Crosscut Initiatives Panel, 2007.
- [24] Anderson, D.M., *Design for Manufacturability & Concurrent Engineering; How to Design for Low Cost, Design for High Quality, Design for Lean Production, and Design Quickly for Fast Production*, CIM Press, 2008.
- [25] Bicheno, J., Holweg M., *The Lean Toolbox*, 4th edition, PICSIE, 2009.
- [26] *Pema Shipbuilding and Offshore Brochure*, Pemamek Oy Ltd, Finland, 2009.
- [27] Liker, J.K., Lamb, T., *A Guide To Lean Shipbuilding*, University of Michigan, Ann Arbor, 2000.
- [28] Storch, R.L. et al.: *Ship Production*, SNAME, New Jersey, 1995.
- [29] *Uljanik Shipyard Archive*, 2009.
- [30] *3.Maj Shipyard Archive*, 2010.
- [31] Fafandjel, N., Pavletić, D., Hadjina, M., *Decision matrix for the panel production line technological improvement policy definition*. Marine Technology V, pp.81-90, ISBN: 1-85312-973-9; ISSN: 1462-6101, Wessex Institute of Technology, Published by WIT Press, 2003, SCOPUS.

- [32] Furlan, Z., Lučin, N., Pavelić, A., *Tehnologija gradnje broskog trupa*, Školska knjiga, Zagreb, 1986.
- [33] Fafandjel, N., Simone, V., Blažević, I., Hadjina, M., *Model linije za izradu panela, istraživačko-razvojni projekt za Brodogradilište "3.Maj"*, Rijeka, 2002.
- [34] Fafandjel, N., Simone, V., Hadjina, M., Matulja, T., *Analiza tokova materijala u fazama predobrade i obrade elemenata trupa, istraživačko-razvojni projekt za Brodogradilište 3.Maj*, Rijeka, 2005.
- [35] Fafandjel, N., Zamarin, A., Ferenčić, M.: *Weld shrinkage compensation in ship hull construction*, Proceedings of 5<sup>th</sup> International Conference on Computer Aided Design and Manufacturing, CADAM 2007, (ISBN 978-953-7142-24-7), pp. 23-25, Medulin, Croatia, 2007.
- [36] *A Guide to the Project Management Body of Knowledge* (3<sup>rd</sup> ed.) Project Management Institute, ISBN 1-930699-45-X, 2003.
- [37] Fafandjel, N., Rubeša, R., Matulja, T., *Improvement of Industrial Production Process Design Using Systematic Layout Planning*, Strojarsstvo/Journal for theory and application in mechanical engineering (ISSN 0562-1887), Vol 51 No.3, pp. 177-186, 2009.
- [38] Fafandjel, N., Pavletić, D., Hadjina, M., book title: *Vessels for Maritime Transportation*, Vol. 1, pp.915-921, ISBN 0415 393736, *Simulation for criteria evaluation in shipbuilding production process layout optimisation*. Published by Taylor and Francis/Balkema, London, UK, 2005 (BMT).
- [39] Fafandjel, N., Simone, V., Gizdulić, B., *Event-driven Network Analysis for Decision Making in Hull Structure Production*, Proceedings of the 7<sup>th</sup> International Conference on Operational Research, Rovinj, September 30-October 2, 1998, pp. 301-310, ISBN 953-6032-26-0.
- [40] Fafandjel, N., Zamarin, A., Hadjina, M.: *Shipyards production costs structure optimisation model related to product type*, International Journal of Production Research, Vol.48, Issue 5., 2010., pp. 1479-1491.
- [41] Levasseur, G.A., Storch, R.L., *A Non-Sequential Just-in-Time Simulation Model*, Computers and Industrial Engineering, Elsevier Science, Vol.30, No.4, pp.741-752, 1996.
- [42] "BETA PERT Distribution" <http://www.riskamp.com/library/pertdistribution.php> (2005.)
- [43] Winston, W.L.: *Introduction to Probability Models Operations Research*, Vol 2, 4th edition, Thomson Learning, Canada, 2004.
- [44] Winston, W.L.: *Operations Research: Applications and Algorithms*, 3rd edition, Duxbury Press, Belmont, 1994.

- [45] Davis, R.: *Teaching Project Simulation in Excel Using PERT-Beta Distributions*, *Informations on Education* 3 (2008) 8, p.285 – 301.
- [46] @RISK, *Advanced Risk Analysis for Spreadsheets*, Palisades Corporation, 2001.
- [47] *Ship Design and Construction*, Society of Naval Architects and Marine Engineers, New Jersey, Vol. 1, 2003.
- [48] INEXA-PROFIL Product Range Lulea, Sweden, 1997.

## 10. LIST OF SYMBOLS AND ABBREVIATIONS

a	height
B	beam, m
c	width (mm)
$C_{KP}$	lean built-up panel assembly transformation time coefficient
$C_M$	lean miscellaneous product transformation coefficient
$C_P$	lean panel assembly transformation time coefficient
$C_S$	lean section assembly transformation coefficient
$C_T$	lean three-dimensional section assembly coefficient
DFP	design for production
DWT	deadweight, tons
$e_x$	distance to the neutral x-axis
$e_y$	distance to the neutral y-axis
FCB	flux-core butt
H	height, m
HP	Holland profile or bulb plate
IPA	interim product assembly
IHOP	integrated hull, outfitting and paiting
KP	built-up panel
Loa	length overall, m
Lbp	length between perpendiculars, m
P	panel
PWBS	product work breakdown structure
r	radius (mm)
s	thickness (mm)
T	three-dimensional section
$T_{design}$	design draft, m
$T_{scantling}$	scantling draft, m
$\Delta_{design}$	design displacement, t
$\Delta_{scantling}$	scantling displacement, t
VT	very large three-dimensional section





## 11. LIST OF FIGURES

Fig. 1.1. Comparison of Japanese shipbuilding productivity and labor costs .....	3
Fig. 1.2. Unit panel and slot assembly method.....	7
Fig. 2.1. Panel-block assembly line.....	9
Fig. 2.2. Illustration of value added time and non-value added time .....	10
Fig. 2.3. The Toyota Production System.....	11
Fig. 2.4. The 5 S's.....	12
Fig. 3.1. Diagram of a product work breakdown structure (PWBS).....	15
Fig. 3.2. Principal block assembly method 1.....	16
Fig. 3.3. Principal block assembly method 2.....	17
Fig. 3.4. Principal block assembly method 3-1 .....	17
Fig. 3.5. Principal block assembly method 3-2 .....	17
Fig. 3.6. Principal block assembly method 4-1 .....	18
Fig. 3.7. Principal block assembly method 4-2 .....	18
Fig. 3.8. Principal block assembly method 5-1 .....	18
Fig. 3.9. Principal block assembly method 5-2 .....	19
Fig. 3.10. Principal block assembly method 1.....	20
Fig. 3.11. Block assembly methods 1a and 1b.....	21
Fig. 3.12. Block assembly methods 1c and 1d.....	22
Fig. 3.13. Block assembly methods 1e and 1f.....	23
Fig. 3.14. Block assembly method 1g .....	24
Fig. 3.15. Principal block assembly method 2.....	32
Fig. 3.16. Block assembly methods 2a and 2b.....	33
Fig. 3.17. Block assembly methods 2c and 2d.....	34
Fig. 3.18. Block assembly methods 2e and 2f.....	35
Fig. 3.19. Block assembly method 2g .....	36
Fig. 3.20. Principal block assembly method 3-1 .....	44
Fig. 3.21. Block assembly methods 3-1a and 3-1b.....	45
Fig. 3.22. Block assembly methods 3-1c and 3-1d.....	46
Fig. 3.23. Block assembly methods 3-1e and 3-1f.....	47
Fig. 3.24. Block assembly method 3-1g.....	48
Fig. 3.25. Principal block assembly method 3-2 .....	56
Fig. 3.26. Block assembly methods 3-2a and 3-2b.....	57
Fig. 3.27. Block assembly methods 3-2c and 3-2d.....	58
Fig. 3.28. Block assembly methods 3-2e and 3-2f.....	59
Fig. 3.29. Block assembly method 3-2g.....	60
Fig. 3.30. Principal block assembly method 4-1 .....	68
Fig. 3.31. Block assembly method 4-1a and 4-1b.....	69
Fig. 3.32. Block assembly methods 4-1c and 4-1d.....	70
Fig. 3.33. Block assembly methods 4-1e and 4-1f.....	71
Fig. 3.34. Block assembly method 4-1g.....	72
Fig. 3.35. Principal block assembly method 4-2 .....	80
Fig. 3.36. Block assembly methods 4-2a and 4-2b.....	81
Fig. 3.37. Block assembly methods 4-2c and 4-2d.....	82
Fig. 3.38. Block assembly methods 4-2e and 4-2f.....	83
Fig. 3.39. Block assembly method 4-2g.....	84
Fig. 3.40. Principal block assembly method 5-1 .....	92
Fig. 3.41. Block assembly methods 5-1a and 5-2b.....	93
Fig. 3.42. Block assembly methods 5-1c and 5-1d.....	94

Fig. 3.43. Block assembly methods 5-1e and 5-1f.....	95
Fig. 3.44. Block assembly method 5-1g.....	96
Fig. 3.45. Principal block assembly method 5-2.....	104
Fig. 3.46. Block assembly methods 5-2a and 5-2b.....	105
Fig. 3.47. Block assembly methods 5-2c and 5-2d.....	106
Fig. 3.48. Block assembly methods 5-2e and 5-2f.....	107
Fig. 3.49. Block assembly method 5-2g.....	108
Fig. 3.50. Block assembly method 1c.....	117
Fig. 3.51: Block assembly methods 2c and 4-1e.....	117
Fig. 3.52. Block assembly method 2e.....	117
Fig. 3.53. Block assembly method 5e.....	118
Fig. 3.54. Typical double bottom block.....	118
Fig. 3.55. Bed plate assembly.....	120
Fig. 3.56. Panel welding.....	120
Fig. 3.57. Panel layout.....	121
Fig. 3.58. Longitudinal fitting.....	121
Fig. 3.59. Longitudinal welding.....	122
Fig. 3.60. Internal structure fitting.....	122
Fig. 3.61. Welding and outfitting of built-up panel.....	122
Fig. 3.62. Turning and fitting.....	123
Fig. 3.63. Internal structure welding.....	123
Fig. 3.64. Unit panel and slot construction.....	124
Fig. 3.65. Unit panel and slot construction—automatic placement and welding of longitudinals.....	124
Fig. 3.66. Unit panel and slot construction—sliding on transverses.....	124
Fig. 3.67. a)Traditional panel assembly vs. b)Unit panel assembly illustration.....	125
Fig. 3.68. Detail of slot for a bulb profile.....	125
Fig. 4.1. Chemical tanker.....	128
Fig. 4.2. Car carrier.....	128
Fig. 4.3. Crane barge.....	128
Fig. 4.4. Chemical tanker breakdown of the parallel middle-body ring.....	129
Fig. 4.5. Car carrier breakdown of the parallel middle-body ring.....	129
Fig. 4.6. Crane barge illustration of the parallel middle body ring.....	130
Fig. 4.7: Double bottom block 3410 VT02 of the Chemical tanker.....	141
Fig. 4.8. Typical block assembly type plan for present state – flat single and double skin blocks: general description.....	142
Fig. 4.9. General plan for assembling the double bottom 3410 VT01 of the Chemical tanker with work phases.....	143
Fig. 4.10: Palet for micropanels.....	145
Fig. 4.11 Typical micropanels.....	146
Fig. 4.12. Workstations on the panel line.....	148
Fig. 4.13. Panels and built-up panels of the Chemical tanker double bottom block.....	150
Fig. 4.14. Three dimensional sections.....	150
Fig. 4.15. Break down of VT02 block of the double bottom for group 3410 of the Chemical tanker.....	151
Fig. 4.16. Breakdown of VT01 block of the double bottom for group 3511 of the Car carrier .....	152
Fig. 4.17. Breakdown of group 3510 - T01 double bottom block for the Crane barge.....	153
Fig. 4.18. “Cerovica D” assembly area.....	154
Fig. 4.19. Workstation 1 Gantt chart.....	155

Fig. 4.20. Workstation 2 Gantt chart .....	156
Fig. 4.21. Workstation 3 Gantt chart .....	157
Fig. 4.22. Workstation 4 Gantt chart .....	158
Fig. 4.23. Workstation 5 Gantt chart .....	159
Fig. 4.24. KP Workstation 1 Gantt chart .....	160
Fig. 4.25. KP Workstation 2 Gantt chart .....	161
Fig. 4.26. KP Workstation 3 Gantt chart .....	162
Fig. 4.27. KP Workstation 4 Gantt chart .....	163
Fig. 4.28. Flow of material during the assembly of the double bottom block for the Chemical tanker in 3.Maj shipyard .....	166
Fig. 4.29. Flow of material during the assembly of the double bottom block for the Car carrier tanker in 3.Maj shipyard .....	1667
Fig. 4.30. Flow of material during the assembly of the double bottom block for the Crane barge in 3.Maj shipyard .....	168
Fig. 5.1. Assembly sequence on the present panel line .....	169
Fig. 5.2. Assembly sequence on the Lean unit panel assembly line .....	170
Fig. 5.3. Assembly sequence on the Lean unit panel assembly line continued .....	171
Fig. 5.4. Assembly sequence on the Lean KP line .....	171
Fig. 5.5. Interim products of the VT double bottom block .....	172
Fig 5.6. The final double bottom block (very large three dimensional section) .....	173
Fig. 5.7. The port side wing tank designated T12 (three dimensional section) .....	173
Fig. 5.8. Assembly of the section S14 which is an interim product of the lower wing tank T12 section of the VT section for the Chemical tanker .....	173
Fig. 5.9. Assembly of the unit panel CA on the micropanel line which is an interim product of the lower wing tank T12 section of the Chemical tanker .....	174
Fig. 5.10. Stool section (T14) three dimensional section .....	174
Fig. 5.11. S15 interim product of the Stool section (T14) .....	175
Fig. 5.12. CA030 interim product of the Stool section (T14) .....	175
Fig. 5.13. Starboard wing tank section designated T22 with interim products S24 and CA019 .....	176
Fig. 5.14. Lean Workstation 1 Gantt chart .....	182
Fig. 5.15. Lean Workstation 2 Gantt chart .....	183
Fig. 5.16. Lean Workstation 3 Gantt chart .....	184
Fig. 5.17. Lean Workstation 4 Gantt chart .....	185
Fig. 5.18. Lean KP Workstation 1 Gantt chart .....	186
Fig. 5.19. Lean KP Workstation 2 Gantt chart .....	187
Fig. 5.20. Typical block assembly type action plan for Lean future state .....	190
Fig. 5.21. Lean transformation of interim product flow .....	191
Fig. 6.1. Examples of the PERT distribution .....	193
Fig. 6.2. Fixed line technology – category 1 .....	196
Fig. 6.3. Fixed line technology – category 2 .....	197
Fig. 6.4. Fixed Line Technology – category 3 .....	197
Fig. 6.5. Fixed line technology – category 4 .....	198
Fig. 6.6. Fixed / changing line technology .....	198
Fig. 6.7. Lean transformation line technology .....	199
Fig. 7.1. Generic midship section of a chemical tanker with constraints for present production program .....	202
Fig. 7.2. Guidelines for flat double skin block assembly .....	205
Fig. 7.3. Typical cutout type penetration .....	205
Fig. 7.4. Typical cutout type penetration type = 102 .....	205

Fig. 7.5. Block assembly method for present state shipyard facilities..... 206  
Fig. 7.6. Block assembly method for future lean transformed state shipyard facilities..... 206  
Fig. 7.7. Illustration of longitudinal spacing symbols..... 206  
Fig. 7.8. Typical cutout type penetration type = 102 ..... 207

## 12. LIST OF TABLES

Tab. 3.1. Assembly option evaluation for block assembly method 1-a.....	25
Tab. 3.2. Assembly option evaluation for block assembly method 1-b .....	26
Tab. 3.3. Assembly option evaluation for block assembly method 1-c.....	27
Tab. 3.4. Assembly option evaluation for block assembly method 1-d .....	28
Tab. 3.5. Assembly option evaluation for block assembly method 1-e.....	29
Tab. 3.6. Assembly option evaluation for block assembly method 1-f.....	30
Tab. 3.7. Assembly option evaluation for block assembly method 1-g .....	31
Tab. 3.8. Assembly option evaluation for block assembly method 2-a.....	37
Tab. 3.9. Assembly option evaluation for block assembly method 2-b .....	38
Tab. 3.10. Assembly option evaluation for block assembly method 2-c.....	39
Tab. 3.11. Assembly option evaluation for block assembly method 2-d .....	40
Tab. 3.12. Assembly option evaluation for block assembly method 2-e.....	41
Tab. 3.13. Assembly option evaluation for block assembly method 2-f.....	42
Tab. 3.14. Assembly option evaluation for block assembly method 2-g .....	43
Tab. 3.15. Assembly option evaluation for block assembly method 3-1a.....	49
Tab. 3.16. Assembly option evaluation for block assembly method 3-1b .....	50
Tab. 3.17. Assembly option evaluation for block assembly method 3-1c.....	51
Tab. 3.18. Assembly option evaluation for block assembly method 3-1d .....	52
Tab. 3.19. Assembly option evaluation for block assembly method 3-1e.....	53
Tab. 3.20. Assembly option evaluation for block assembly method 3-1f.....	54
Tab. 3.21. Assembly option evaluation for block assembly method 3-1g .....	55
Tab. 3.22. Assembly option evaluation for block assembly method 3-2a.....	61
Tab. 3.23. Assembly option evaluation for block assembly method 3-2b .....	62
Tab. 3.24. Assembly option evaluation for block assembly method 3-2c.....	63
Tab. 3.25. Assembly option evaluation for block assembly method 3-2d .....	64
Tab. 3.26. Assembly option evaluation for block assembly method 3-2e.....	65
Tab. 3.27. Assembly option evaluation for block assembly method 3-2f.....	66
Tab. 3.28. Assembly option evaluation for block assembly method 3-2g .....	67
Tab. 3.29. Assembly option evaluation for block assembly method 4-1a.....	73
Tab. 3.30. Assembly option evaluation for block assembly method 4-1b .....	74
Tab. 3.31. Assembly option evaluation for block assembly method 4-1c.....	75
Tab. 3.32. Assembly option evaluation for block assembly method 4-1d .....	76
Tab. 3.33. Assembly option evaluation for block assembly method 4-1e.....	77
Tab. 3.34. Assembly option evaluation for block assembly method 4-1f.....	78
Tab. 3.35. Assembly option evaluation for block assembly method 4-1g .....	79
Tab. 3.36. Assembly option evaluation for block assembly method 4-2a.....	85
Tab. 3.37. Assembly option evaluation for block assembly method 4-2b .....	86
Tab. 3.38. Assembly option evaluation for block assembly method 4-2c.....	87
Tab. 3.39. Assembly option evaluation for block assembly method 4-2d .....	88
Tab. 3.40. Assembly option evaluation for block assembly method 4-2e.....	89
Tab. 3.41. Assembly option evaluation for block assembly method 4-2f.....	90
Tab. 3.42. Assembly option evaluation for block assembly method 4-2g .....	91
Tab. 3.43. Assembly option evaluation for block assembly method 5-1a.....	97
Tab. 3.44. Assembly option evaluation for block assembly method 5-1b .....	98
Tab. 3.45. Assembly option evaluation for block assembly method 5-1c.....	99
Tab. 3.46. Assembly option evaluation for block assembly method 5-1d .....	100

Tab. 3.47. Assembly option evaluation for block assembly method 5-1e .....	101
Tab. 3.48. Assembly option evaluation for block assembly method 5-1f .....	102
Tab. 3.49. Assembly option evaluation for block assembly method 5-1g.....	103
Tab. 3.50. Assembly option evaluation for block assembly method 5-2a.....	109
Tab. 3.51. Assembly option evaluation for block assembly method 5-2b.....	110
Tab. 3.52. Assembly option evaluation for block assembly method 5-2c.....	111
Tab. 3.53. Assembly option evaluation for block assembly method 5-2d.....	112
Tab. 3.54. Assembly option evaluation for block assembly method 5-2e.....	113
Tab. 3.55. Assembly option evaluation for block assembly method 5-2f.....	114
Tab. 3.56. Assembly option evaluation for block assembly method 5-2g.....	115
Tab. 3.57. Summary of block assembly method evaluations.....	116
Tab. 4.1. Design variations – Chemical tanker double skin blocks.....	131
Tab. 4.2. Design variations – car carrier double skin blocks.....	132
Tab. 4.3. Design variations – crane barge double skin blocks.....	133
Tab. 4.4. Design variations – crane barge double skin blocks.....	134
Tab. 4.5. Structural configuration variations – Chemical tanker double skin blocks.....	136
Tab. 4.6. Structural Configuration Variations – Car Carrier Double Skin Blocks.....	137
Tab. 4.7. Structural configuration variations – crane barge double skin blocks.....	138
Tab. 4.8. Structural Configuration Variations – Crane Barge Double Skin Blocks.....	139
Tab. 4.9. Summary of work content analysis.....	141
Tab. 4.10. Man hours for assembling a stiffened panel on the panel line for all three vessel types.....	147
Tab. 4.11. Man hours for assembling typical built-up panels for all three vessel types.....	149
Tab. 4.12. Man-hours for the assembly of three dimensional (T) blocks for the Chemical tanker.....	151
Tab. 4.13. Breakdown of VT02 block, group 3410 for the Chemical tanker into man-hours and weight.....	152
Tab. 4.14. Breakdown of VT01 block, group 3511 for the Car carrier into man-hours and weight.....	153
Tab. 5.1. Assembly time of interim products for the VT double bottom block.....	170
Tab. 5.2. Present day panel-block assembly workstations vs Lean transformation of panel block assembly workstations.....	176
Tab. 5.3. Illustration of present day workstations vs. Lean transformed workstations.....	178
Tab. 5.4. Man-hours comparison for unit panel assembly of P121 for the Chemical tanker.....	188
Tab. 5.5. Lean transformation man-hours for assembling a built-up panel KP12 for the Chemical tanker.....	188
Tab. 5.6. Interim products assembly times in hours.....	189
Tab. 6.1. Monte Carlo input table in Excel.....	195
Tab. 7.1. Main characteristics of the panel line of 3.Maj shipyard.....	203
Tab. 7.2. Characteristics of the micropanel line and built-up panel lines.....	204
Tab. 7.3. Longitudinal dimensions of bulb profiles for the chemical tanker.....	207

### 13. APPENDIX

#### APPENDIX : Case study material

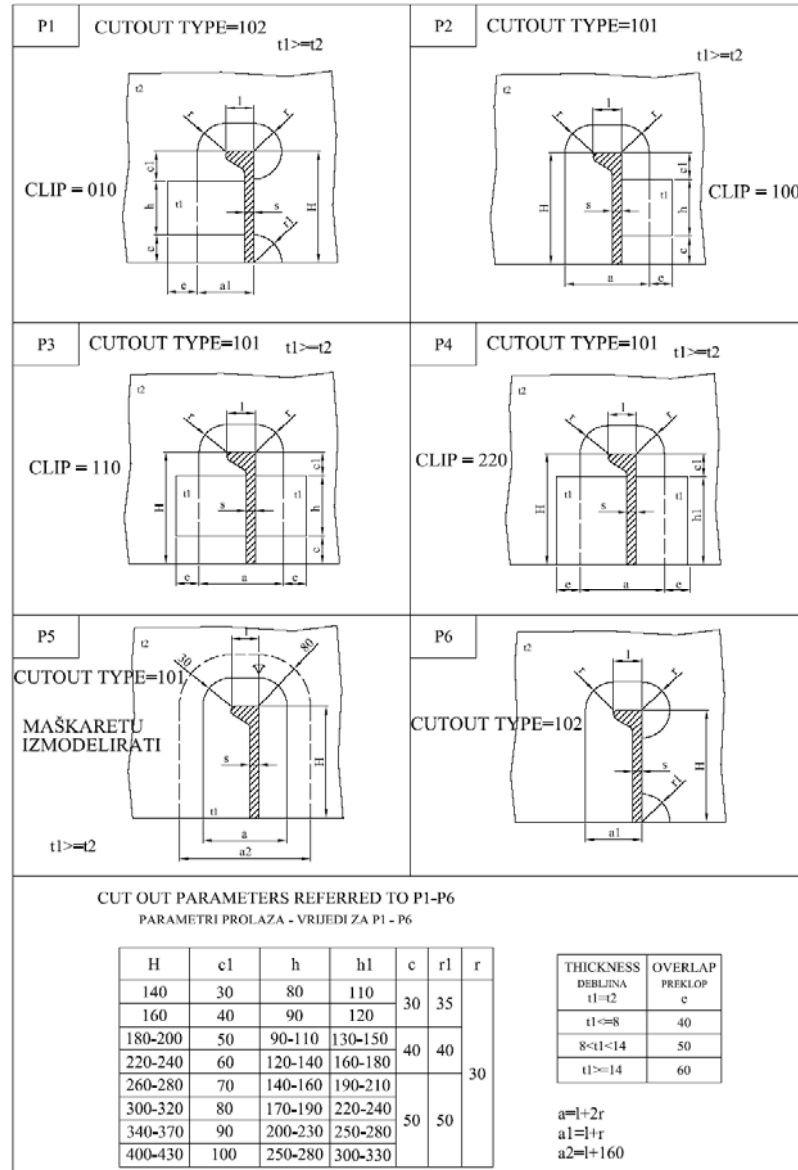


Fig. A1. Shipyard penetration standards [30]



**Tab. A1.** Design Variations for the Chemical tanker upper deck [2], [30]

<b>Chemical Tanker Carrier</b>					
<b>No.</b>	<b>Key areas of variation</b>	<b>Upper Deck</b>			
		<b>Group 3480 VT01</b>			
		<b>KP11</b>	<b>KP21</b>	<b>KP12</b>	<b>KP22</b>
1	<b>Plate thickness Number of plates per panel</b>	14 mm, 5 plates per panel	14 mm, 4 plates per panel	14 mm, 5 plates per panel	14 mm, 4 plates per panel
2	<b>Longitudinal scantlings</b>	longitudinals 280x11, 240x12	longitudinals 280x11, 240x12	longitudinals 280x11	longitudinals 280x11
3	<b>Type of section</b>	bulb	bulb	bulb	bulb
4	<b>Longitudinal spacing (mm)</b>	800	800	800	800
5	<b>No. of longitudinals per panel</b>	13 longitudinals 280x11 1 longitudinal 240x12	13 longitudinals 280x11 1 longitudinal 240x12	14 longitudinals	14 longitudinals
6	<b>Spacing of webs (mm)</b>	1700	1700	1700/3400	1700/3400
7	<b>No. of webs per panel</b>	6	6	5	5
8	<b>Depth of webs (mm)</b>	610 x12 T assembly	610 x12 T assembly	610 x12 T assembly, 1100 x15 T assembly	610 x12 T assembly, 1100 x15 T assembly
9	<b>Panel dimensions</b>	11046x13116	11046x11076	11046x13116	11046x11076
10	<b>Panel weight (t)</b>	35,5 t	30,7 t	32,2 t	27,5 t
11	<b>Block weight (t)</b>	168,3 t	168,3 t	168,3 t	168,3 t
12	<b>Steel quality</b>	A, B, D	A, B, D	A, B, D	A, B, D
13	<b>Direction of plate straking</b>	longitudinal bow-stern	longitudinal bow-stern	longitudinal bow-stern	longitudinal bow-stern

**Tab. A2.** Design Variations – Chemical Tanker Double Skin Blocks [2], [30]

<b>Chemical Tanker</b>					
<b>No.</b>	<b>Key areas of variation</b>	<b>Double-Bottom</b>			
		<b>Group 3410 - VT01 Erection Block</b>			
		<b>KP11 double bottom top</b>	<b>KP21 double bottom top</b>	<b>P111 outer hull bottom</b>	<b>P211 outer hull bottom</b>
1	<b>Plate thickness Number of plates per panel</b>	16 mm 4 plates per panel	16 mm 4 plates per panel	15 mm, 17,5 mm 5 plates per panel	15 mm 4 plates per panel
2	<b>Longitudinal scantlings (mm)</b>	longitudinals 370x13 2 longitudinal girders 2180x12, 2180x14,5 tunnel 2180x20	longitudinals 370x13, bars 180x13 2 longitudinal girders 2180x12, 2180x14,5 tunnel 2180x20	longitudinals 340x14, bar 250x16	longitudinals 340x14
3	<b>Type of section</b>	HP / plate	HP / bar / plate	HP / bar	HP
4	<b>Longitudinal spacing (mm)</b>	800	800	800	800
5	<b>No. of longitudinals per panel</b>	12 longitudinals 2 longitudinal girders tunnel	12 longitudinals 1 bar 2 longitudinal girders tunnel	13 longitudinals 1 bar	13 longitudinals
6	<b>Spacing of webs (mm)</b>	3400	3400	x	3400
7	<b>No. of webs per panel</b>	3	3	x	x
8	<b>Depth of webs (mm)</b>	2180	2180	x	x
9	<b>Panel dimensions</b>	11046x11998	11046x12078	11046x14336	11046x11876
10	<b>Panel weight (t)</b>	45,4 t	48,7 t	27,5 t	23,4 t
11	<b>Block weight (t)</b>	222 t	222 t	222 t	222 t
12	<b>Steel quality</b>	A	A	A	A
13	<b>Direction of plate straking</b>	longitudinal bow-stern	longitudinal bow-stern	longitudinal bow-stern	longitudinal bow-stern

**Tab. A3.** Design Variations – Chemical Tanker Double Skin Blocks [2], [30]

<b>Chemical Tanker</b>					
<b>No.</b>	<b>Key areas of variation</b>	<b>Double-Sided</b>			
		<b>Group 3450 - VT11 (VT21) Erection Blocks</b>		<b>Group 3450 - VT12 (VT22) Erection Blocks</b>	
		<b>KP11 (KP21) longitudinal blkhd. of wing tank</b>	<b>P111 (P211) Outer hull plating</b>	<b>KP12 Longitudinal blkhd of wing tank</b>	<b>P121 (P221) Outer hull plating</b>
1	<b>Plate thickness Number of plates per panel</b>	12,5, 13, 14 mm 4 plates per panel	14,5, 17,5 mm 5 plates per panel	12,5, 13, 14 mm 4 plates per panel	14,5, 17,5 mm 5 plates per panel
2	<b>Longitudinal scantlings</b>	longitudinals 300x12, 320x12, 280x11, 280x12 stringers 2000x11/12	longitudinals 240x12, 260x10, 280x11	longitudinals 300x12, 320x12, 280x11, 280x12 stringers 2000x11/12	longitudinals 240x12, 260x10, 280x11
3	<b>Type of section</b>	bulb / plate	bulb	bulb / plate	bulb
4	<b>Longitudinal spacing (mm)</b>	810	405 / 810 / 760	810	405 / 810 / 760
5	<b>No. of longitudinals per panel</b>	11 longitudinals 2 stringers	14 longitudinals	11 longitudinals 2 stringers	14 longitudinals
6	<b>Spacing of webs (mm)</b>	3400	x	3400	x
7	<b>No. of webs per panel</b>	3	x	3	x
8	<b>Depth of webs (mm)</b>	2000	x	2000	x
9	<b>Panel dimensions</b>	11044x10507	11044x12766	11044x10507	11044x12766
10	<b>Panel weight (t)</b>	27,6 t	23,6 t	28,2 t	23,7 t
11	<b>Block weight (t)</b>	75 t	75 t	75,8 t	75,8 t
12	<b>Steel quality</b>	A, B, D	A, B, D	A, B, D	A, B, D
13	<b>Direction of plate straking</b>	longitudinal bow- stern	longitudinal bow- stern	longitudinal bow- stern	longitudinal bow- stern

**Tab. A4.** Design variations for a Car Carrier Group 3552 – VT11 Erection Block [2], [30]

<b>Car Carrier</b>						
<b>No.</b>	<b>Key areas of variation</b>	<b>Side shell – upper part</b>				
		<b>Group 3552- VT 11 Erection Block</b>				
		<b>P110</b>	<b>P111</b>	<b>P310</b>	<b>P311</b>	<b>P312</b>
1	<b>Plate thickness Number of plates per panel</b>	11 mm, 12 mm 4 plates per panel	11 mm 2 plates per panel	11 mm, 12 mm 3 plates per panel	11 mm 3 plates per panel	15 mm, 20 mm 3 plates per panel
2	<b>Longitudinal scantlings</b>	transverse frame 280x11	x	x	transverse frame 300x12	x
3	<b>Type of section</b>	HP	x	x	HP	x
4	<b>Longitudinal spacing (mm)</b>	850	x	x	850	x
5	<b>No. of longitudinals per panel</b>	10	x	x	4	x
6	<b>Spacing of webs (mm)</b>	3400	x	x	x	x
7	<b>No. of webs per panel</b>	4	x	x	x	x
8	<b>Depth of webs (mm)</b>	HP340X12	x	x	x	x
9	<b>Panel dimensions</b>	11750x10070	11750x5330	12800x7390	7750x8010	4682x8010
10	<b>Panel weight (t)</b>	15,4 t	5,6 t	8,7 t	6,5 t	5,8 t
11	<b>Block weight (t)</b>	102,2 t	102,2 t	102,2 t	102,2 t	102,2 t
12	<b>Steel quality</b>	A	A	A	A	A
13	<b>Direction of plate straking</b>	longitudinal bow-stern	longitudinal bow-stern	longitudinal bow-stern	longitudinal bow-stern	longitudinal bow-stern

**Tab. A5.** Design variations for a Car Carrier Group 3552 – VT12 Erection Block [2], [30]

<b>Car Carrier</b>						
<b>No.</b>	<b>Key areas of variation</b>	<b>Side shell – upper part</b>				
		<b>Group 3552 – VT 21 Erection Block</b>				
		<b>P210</b>	<b>P211</b>	<b>P410</b>	<b>P411</b>	<b>P412</b>
1	<b>Plate thickness Number of plates per panel</b>	11 mm, 12 mm 4 plates per panel	11 mm 2 plates per panel	11 mm, 12 mm 3 plates per panel	11 mm 3 plates per panel	15 mm, 20 mm 3 plates per panel
2	<b>Longitudinal scantlings</b>	transverse frame 280x11	x	x	transverse frame 300x12	x
3	<b>Type of section</b>	HP	x	x	HP	x
4	<b>Longitudinal spacing (mm)</b>	850	x	x	850	x
5	<b>No. of longitudinals per panel</b>	10	x	x	6	x
6	<b>Spacing of webs (mm)</b>	3400	x	x	x	x
7	<b>No. of webs per panel</b>	4	x	x	x	x
8	<b>Depth of webs (mm)</b>	HP340X12	x	x	x	x
9	<b>Panel dimensions</b>	11750X10070	11750x5330	12800x7390	7750x8010	5050x8010
10	<b>Panel weight (t)</b>	15,4 t	5,6 t	8,7 t	6,9 t	6 t
11	<b>Block weight (t)</b>	102,2 t	102,2 t	102,2 t	102,2 t	102,2 t
12	<b>Steel quality</b>	A	A	A	A	A
13	<b>Direction of plate straking</b>	longitudinal bow-stern	longitudinal bow-stern	longitudinal bow-stern	longitudinal bow-stern	longitudinal bow-stern

**Tab. A6.** Design variations for a Car carrier Group 3585 – T11 and T21 sub-Erection Blocks [2], [30]

<b>Car Carrier</b>					
<b>No.</b>	<b>Key areas of variation</b>	<b>Upper Deck (No. 12)</b>			
		<b>Group 3585 - T11 Sub block</b>		<b>Group 3585 - T21 Sub block</b>	
		<b>KP11</b>	<b>KP12</b>	<b>KP21</b>	<b>KP22</b>
1	<b>Plate thickness Number of plates per panel</b>	6 mm 5 plates per panel	6 mm 5 plates per panel	6 mm 5 plates per panel	6 mm 5 plates per panel
2	<b>Longitudinal scantlings</b>	longitudinals 140x7 longitudinal girder 530x12	longitudinals 140x7 longitudinal girder 530x12	longitudinals 140x7 longitudinal girder 530x12	longitudinals 140x7 longitudinal girder 530x12
3	<b>Type of section</b>	HP / T assembly	HP / T assembly	HP / T assembly	HP / T assembly
4	<b>Longitudinal spacing (mm)</b>	750	750	750	750
5	<b>No. of longitudinals per panel</b>	15 longitudinals + 1 longitudinal girder	15 longitudinals + 1 longitudinal girder	15 longitudinals + 1 longitudinal girder	15 longitudinals + 1 longitudinal girder
6	<b>Spacing of webs (mm)</b>	3400	3400	3400	3400
7	<b>No. of webs per panel</b>	4	3	4	3
8	<b>Depth of webs (mm)</b>	320x12 T assembly	320x12 T assembly	320x12 T assembly	320x12 T assembly
9	<b>Panel dimensions</b>	11800x11490	11300x11490	11800x11190	11300x11190
10	<b>Panel weight (t)</b>	13,7 t	12,5 t	13,2 t	12 t
11	<b>Block weight (t)</b>	29,5 t	29,5 t	28,5 t	28,5 t
12	<b>Steel quality</b>	A	A	A	A
13	<b>Direction of plate straking</b>	longitudinal bow-stern	longitudinal bow-stern	longitudinal bow-stern	longitudinal bow-stern

**Tab. A7.** Design variations for a Car Carrier Groups 3560: T01-KP11 and 21 and T02- KP12 and 22 sub-Erection Blocks [2], [30]

<b>Car Carrier</b>					
<b>No.</b>	<b>Key areas of variation</b>	<b>Decks</b>			
		<b>Deck No.2 - Group 3560</b>			
		<b>T01-KP11</b>	<b>T01-KP21</b>	<b>T12-KP12</b>	<b>T22-KP22</b>
1	<b>Plate thickness Number of plates per panel</b>	6 mm, 8mm 6 plates per panel	6 mm, 8mm 7 plates per panel	6 mm 6 plates per panel	6 mm 6 plates per panel
2	<b>Longitudinal scantlings</b>	longitudinals 100x7 longitudinal girder 280x12	longitudinals 100x7 longitudinal girder 280x12	longitudinals 100x7 longitudinal girder 280x12	longitudinals 100x7 longitudinal girder 280x12
3	<b>Type of section</b>	HP / T assembly	HP / T assembly	HP / T assembly	HP / T assembly
4	<b>Longitudinal spacing (mm)</b>	750	750	750	750
5	<b>No. of longitudinals per panel</b>	15 longitudinals + 1 longitudinal girder	14 longitudinals + 1 longitudinal girder	15 longitudinals + 1 longitudinal girder	14 longitudinals + 1 longitudinal girder
6	<b>Spacing of webs (mm)</b>	3400	3400	6800	6800
7	<b>No. of webs per panel</b>	4	4	2	2
8	<b>Depth of webs (mm)</b>	280x8 T assembly	280x8 T assembly	280x8 T assembly	280x8 T assembly
9	<b>Panel dimensions</b>	11796x12164	11800x11865	11796x12165	11800x11867
10	<b>Panel weight (t)</b>	11,9 t	11,2 t	11,1 t	10,8 t
11	<b>Block weight (t)</b>	24,7 t	24,7 t	15,9 t	15,5 t
12	<b>Steel quality</b>	A	A	A	A
13	<b>Direction of plate straking</b>	longitudinal bow-stern	longitudinal bow-stern	longitudinal bow-stern	longitudinal bow-stern

**Tab. A8.** Design variations for a Car carrier Groups 3564 T11-KP11 and KP21 and T02-KP12 and KP22 sub-erection blocks [2], [30]

<b>Car Carrier</b>					
<b>No.</b>	<b>Key areas of variation</b>	<b>Decks</b>			
		<b>Deck No. 6 - Group 3564</b>			
		<b>T11-KP11</b>	<b>T21-KP21</b>	<b>T02-KP12</b>	<b>T02-KP22</b>
1	<b>Plate thickness Number of plates per panel</b>	16 mm, 5 plates per panel	16 mm, 5 plates per panel	16 mm, 5 plates per panel	16 mm, 5 plates per panel
2	<b>Longitudinal scantlings</b>	longitudinals 320x12 longitudinal girder 770x25	longitudinals 320x12 longitudinal girder 770x25	longitudinals 320x12 longitudinal girder 770x25	longitudinals 320x12 longitudinal girder 770x25
3	<b>Type of section</b>	HP / T assembly	HP / T assembly	HP / T assembly	HP / T assembly
4	<b>Longitudinal spacing (mm)</b>	750	750	750	750
5	<b>No. of longitudinals per panel</b>	16 longitudinals + 1 girder	15 longitudinals + 1 longitudinal girder	17 longitudinals + 1 longitudinal girder	16 longitudinals + 1 longitudinal girder
6	<b>Spacing of webs (mm)</b>	3400	3400	3400	3400
7	<b>No. of webs per panel</b>	2	2	4	4
8	<b>Depth of webs (mm)</b>	770x12 T assembly	770x12 T assembly	770x12 T assembly	770x12 T assembly
9	<b>Panel dimensions</b>	12800x12500	12800x12200	12800/10650x13200	12800x12900
10	<b>Panel weight (t)</b>	39,2 t	40 t	39,9 t	41,5 t
11	<b>Block weight (t)</b>	56,7 t	53,4 t	82,2 t	82,2 t
12	<b>Steel quality</b>	A	A	A	A
13	<b>Direction of plate straking</b>	longitudinal bow-stern	longitudinal bow-stern	longitudinal bow-stern	longitudinal bow-stern



**Tab. A9.** Structural configuration variations – Chemical tanker double skin blocks [2], [30]

<b>Chemical Tanker</b>					
<b>Blocks analyzed</b>		<b>Double bottom</b>			
		<b>Group 3410 - VT01 Erection Block</b>			
<b>Configuration</b>		<b>KP11 double bottom top (inner bottom)</b>	<b>KP21 double bottom top (inner bottom)</b>	<b>P111 outer hull bottom</b>	<b>P211 outer hull bottom</b>
<b>Longitudinal web penetration (panel stiffening)</b>	<b>Fitted slots</b>	X	X	X	X
	<b>One side fitted and one lug</b>	12	12	X	X
	<b>One side fitted without lug</b>	X	X	X	X
	<b>Tight collar</b>	X	X	X	X
	<b>Open cut-out without lugs</b>	X	X	X	X
<b>Web stiffeners</b>	<b>Stiffener dimensions</b>	150x12	150x12	X	X
	<b>Stiffener type</b>	bar	bar	X	X
	<b>Connection with longitudinals</b>	Vertical, welded in line with longitudinals	Vertical, welded in line with longitudinals	X	X
<b>Web configuration</b>	<b>Web frame dimensions</b>	2180x12/14	2180x12/14	X	X
	<b>Type of web frame</b>	small sub assembly unit	small sub assembly unit	X	X
<b>Air holes</b>	<b>Adjacent to plate</b>	X	X	X	X
	<b>Off the plate</b>	X	X	X	X
<b>Drain holes</b>	<b>Adjacent to plate</b>	X	X	X	X
	<b>Off the plate</b>	X	X	X	X

**Tab. A10.** Structural configuration variations – Chemical tanker double skin blocks [2], [30]

<b>Chemical Tanker</b>					
<b>Blocks analyzed</b>		<b>Double bottom</b>			
		<b>Group 3450 - VT11 (VT21)</b>		<b>Group 3450 - VT12 (VT22)</b>	
<b>Configuration</b>		<b>KP11 (KP21) longitudinal bulkhead of wing tank</b>	<b>P111 (P211) outer hull</b>	<b>KP12 longitudinal blkhd of wing tank</b>	<b>P121 (P221) outer hull</b>
<b>Longitudinal web penetration (panel stiffening)</b>	<b>Fitted slots</b>	X	X	X	X
	<b>One side fitted and one lug</b>	9	X	9	X
	<b>One side fitted without lug</b>	X	X	X	X
	<b>Tight collar</b>	2	X	2	X
	<b>Open cut-out without lugs</b>	X	X	X	X
<b>Web stiffeners</b>	<b>Stiffener dimensions</b>	150x11	X	150x11	X
	<b>Stiffener type</b>	bar	X	bar	X
	<b>Connection with longitudinals</b>	Vertical, welded in line with longitudinals	X	Vertical, welded in line with longitudinals	X
<b>Web configuration</b>	<b>Web frame dimensions</b>	2000x11	X	2000x11	X
	<b>Type of web frame</b>	small sub assembly unit	X	small sub assembly unit	X
<b>Air holes</b>	<b>Adjacent to plate</b>	X	X	X	X
	<b>Off the plate</b>	X	X	X	X
<b>Drain holes</b>	<b>Adjacent to plate</b>	X	X	X	X
	<b>Off the plate</b>	X	X	X	X



**Fig. A2.** Micropanel line [30]



**Fig. A3.** Crane for transporting kavalets [30]



**Fig. A4.** Robotic line [30]

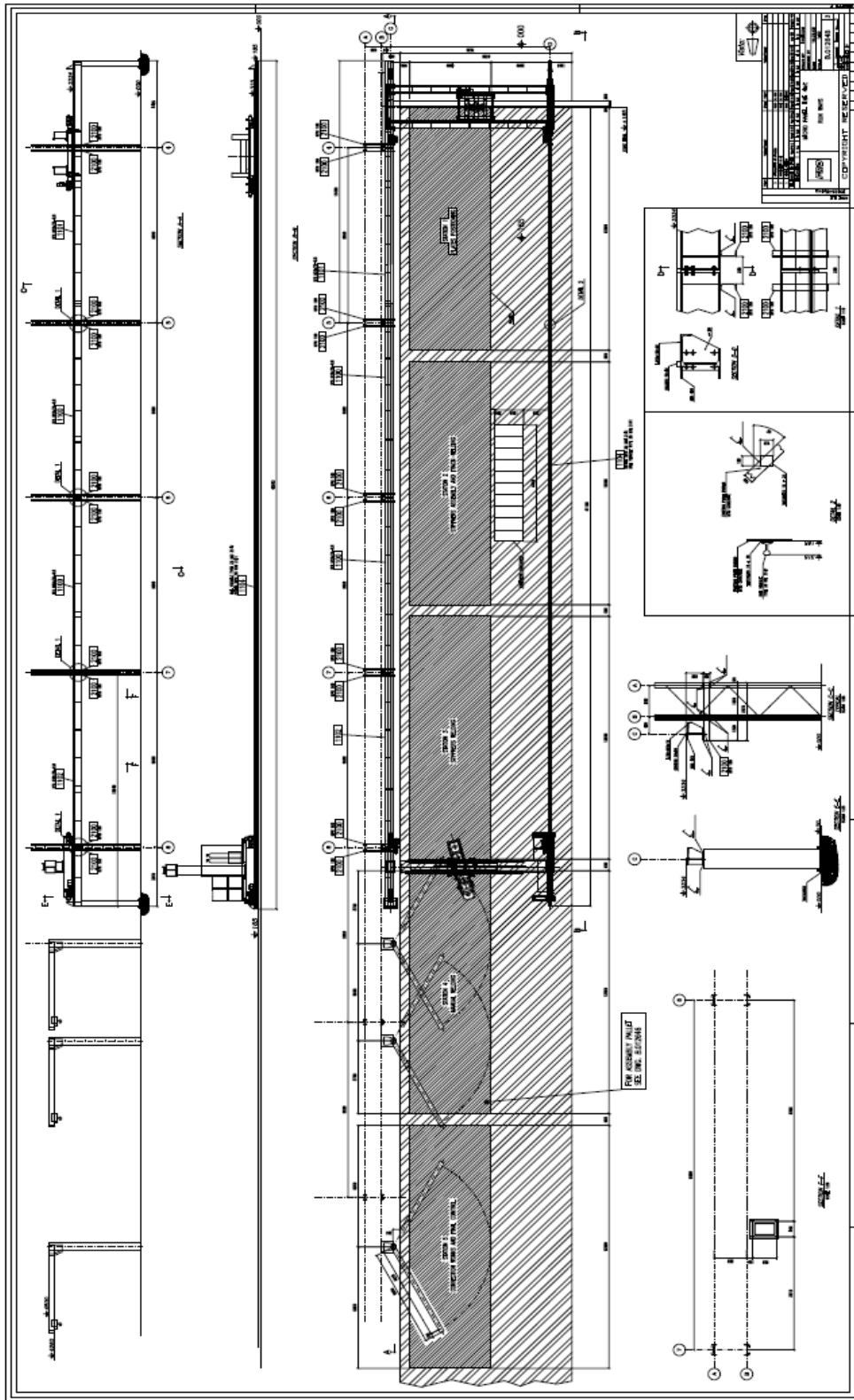


Fig. A5. Micropanel-line (Layout details of work areas) [30]

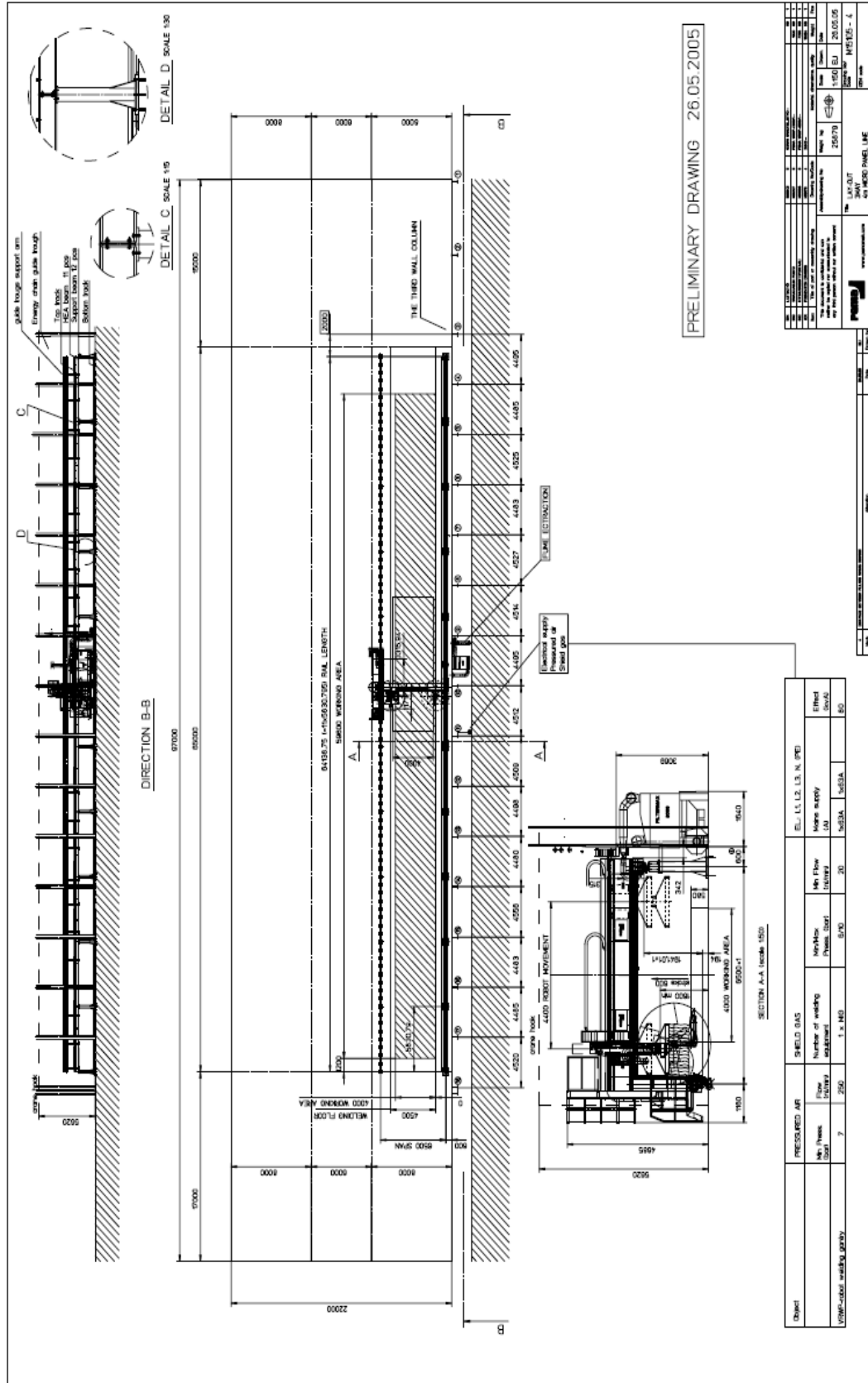
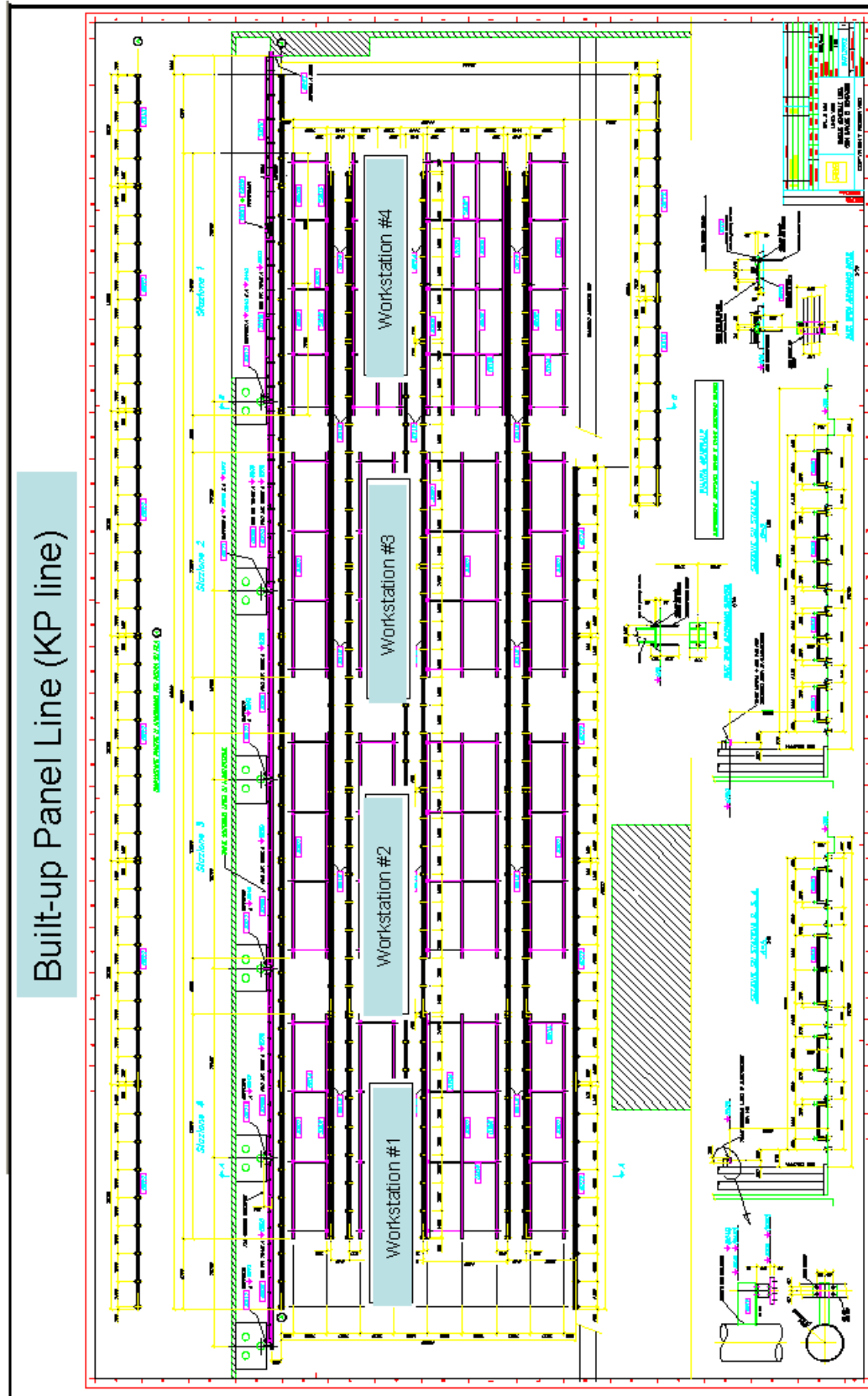


Fig. A6. Robotic line (Layout details of the work areas) [30]



Built-up Panel Line (KP line)

Fig. A7. Built-up panel (KP) line with workstations [30]



## SUMMARY RESUME

Damir Kolić was born May 28, 1974 in New York, USA. Upon completion of the Bronx High School of Science in June 1992, he attended Webb Institute of Naval Architecture, where he was graduated in June of 1996, 3<sup>rd</sup> in his class.

He worked as a translator-interpreter for AIHA, a partnership program between the United States and Croatia in the period of July 1996 till July 1998. In September 1998, he was employed in Brodosplit shipyard in the Project-Sales until January 2000. Then he was employed in Alvaz Construction Corporation in New York until June 2004. In February of 2005, he is employed in the Project-Sales department of Kraljevica shipyard until January 2008. From February till October 2008 he is employed in the Naval and Special Vessel shipyard – Brodosplit, and in November 2008 he started his employment as an assistant in the Naval Architecture and Ocean Engineering (Technology and Organization) Department, Faculty of Engineering, University of Rijeka.

He is an author of scientific articles.

He actively speaks and writes in English and Croatian.





**INFORMATION ABOUT THE AUTHOR AND THE DISSERTATION****1. AUTHOR**

First and last name: Damir Kolić  
Date and place of birth: 28.05.1974. New York, USA  
Name of college, major and year  
Completion of diploma: Webb Institute of Naval Architecture, B.S. in Naval Architecture and Marine Engineering, 1996.  
Name of college, major and year  
Completion of post graduate studies: Faculty of Engineering, University of Rijeka, Design and construction of vessels, PhD studies, 2011.  
Present employment: Assistant

**2. DISSERTATION**

Title: Methodology for improving flow to achieve lean manufacturing in shipbuilding

Number of pages, figures, tables & bibliographical data: 245, 140, 81, 48  
Scientific field and branch: Naval Architecture, Technology and organization  
Mentor: Prof. D.Sc. Nikša Fafandjel  
College of thesis defense: Faculty of Engineering, University of Rijeka

**3. DEFENSE AND EVALUATION**

Date of topic registration: 25.09.2009.  
Date of dissertation submittal: 13.04.2011.  
Date of dissertation evaluation acceptance: 27.05.2011.  
Evaluation committee members: Prof. Emeritus D.Sc. Špiro Milošević  
Prof. D.Sc. Nikša Fafandjel  
Prof. Ph.D. Richard Lee Storch  
Date of dissertation defense: 16.06.2011.  
Defense committee members: Prof. Emeritus D.Sc. Špiro Milošević  
Prof. D.Sc. Nikša Fafandjel  
Prof. D.Sc. Roko Markovina  
Date of promotion:



Code: DD No.

UDC 629.5.01:658.512.012:519.245(043)

**METHODOLOGY FOR IMPROVING FLOW TO ACHIEVE LEAN  
MANUFACTURING IN SHIPBUILDING**

Damir Kolić

University of Rijeka  
Faculty of Engineering  
Croatia

Key words: shipbuilding process  
lean manufacturing  
lean transformation  
design for production  
risk analysis

**Summary:** The aim of this dissertation is to provide a methodology for improving flow of interim products by applying the *lean manufacturing* concept. Since shipyard management is usually not sure how to approach a transformation of its facilities due to the risks involved, this dissertation couples lean transformation with risk analysis to compare the key parameter for comparing productivity, man-hours. Based upon this it is clear that while making *design for production (DFP)* changes will improve productivity up to 30% when technology changes are made in complement with methodology changes, application of the *lean manufacturing* methodology brings productivity improvements of 60%.

This PhD thesis is not published

Mentor: Prof. D.Sc. Nikša Fafandjel

Evaluation committee: Prof. Emeritus D.Sc. Špiro Milošević  
Prof. D.Sc. Nikša Fafandjel  
Prof. Ph.D. Richard Lee Storch (Chair of Industrial and  
Systems Engineering, University of Washington, Seattle,  
USA)Defense committee: Prof. Emeritus D.Sc. Špiro Milošević  
Prof. D.Sc. Nikša Fafandjel  
Prof. D.Sc. Roko Markovina (Faculty of Electrical  
Engineering, Mechanical Engineering and Naval  
Architecture, Split)Presentation: 16.06.2011.

Degree conferred:

This thesis is deposited in the library of the University of Rijeka, Faculty of Engineering.  
(245, 140, 81, 48, English language)

UDC 629.5.01:658.512.012:519:245(043)

Methodology for improving flow

to achieve lean manufacturing

in shipbuilding

I D. Kolić

II University of Rijeka  
Faculty of Engineering  
Croatia

shipbuilding process  
lean manufacturing  
lean transformation  
design for production  
risk analysis

Key words:

Oznaka: DD

Tek. broj:

UDK 629.5.01:658.512.012:519.245(043)

**METODOLOGIJA ZA UNAPREĐENJE BRODOGRAĐEVNIH PROCESA  
TEMELJENA NA KONCEPTU VITKE PROIZVODNJE**

Damir Kolić

Sveučilište u Rijeci  
Tehnički Fakultet  
Hrvatska

Ključne riječi:                   brodograđevni proces  
  vitka proizvodnja  
  vitka transformacija  
  projektiranje za proizvodnju  
  analiza rizika

Sažetak: Cilj ove disertacije je omogućiti metodologiju za poboljšanje protoka međuproizvoda kroz primjenu koncepta *vitke proizvodnje*. Uprave brodogradilišta često puta nisu sigurne kako najbolje pristupiti transformaciji svojih postrojenja radi postojećih rizika. Ova disertacija povezuje vitku transformaciju sa analizom rizika radi usporedbe ključnog parametra u uspoređivanju produktivnosti, efektivnih radni sati. Postaje jasno kako kreiranje promjene korištenjem koncepta *projektiranja za proizvodnju* poboljšava proizvodnju do 30% kada promjene na tehnologiji se naprave komplementarno sa metodologijom, aplikacija koncepta *vitke proizvodnje* donosi poboljšanje proizvodnje do 60%.

Rad nije objavljen.

Mentor:                               Prof. dr. sc. Nikša Fafandjel

Povjerenstvo za ocjenu:       Prof. emeritus dr. sc. Špiro Milošević  
  Prof. dr. sc. Nikša Fafandjel  
  Prof. dr. sc. Richard Lee Storch (Chair of Industrial and  
  Systems Engineering, University of Washington, Seattle,  
  USA)Povjerenstvo za obranu:       Prof. Emeritus D.Sc. Špiro Milošević  
  Prof. D.Sc. Nikša Fafandjel  
  Prof. D.Sc. Roko Markovina (Fakultet elektrotehnike,  
  strojarstva i brodogradnje, Split)Datum obrane: 16.06.2011.

Datum promocije:

Rad je pohranjen na Tehničkom fakultetu Sveučilišta u Rijeci.  
(245, 140, 81, 48, engleski jezik)

DD  
Metodologija za mapredenje  
broadgrademih procesa  
temeljena na konceptu  
vitke proizvodnje  
I D. Kolić  
II Sveučilište u Rijeci  
Tehnički fakultet  
Hrvatska

Ključne riječi:  
broadgrademih proces  
vitka proizvodnja  
vitka transformacija  
projekiranje za proizvodnju  
analiza rizika

UDK 629.5.01:658.512.012:519:245(043)